

Radio-Electronics

MAY

TELEVISION • SERVICING • HIGH FIDELITY

HUGO GERNSBACK, Editor-in-chief

**Latest FM Stereo
Multiplex Schematics**

**Useful Service Technique—
High-Voltage Substitution**

**Industrial Technicians'
Pocket Service Kit**

**Should I Build a Kit
Or Build from Scratch?**

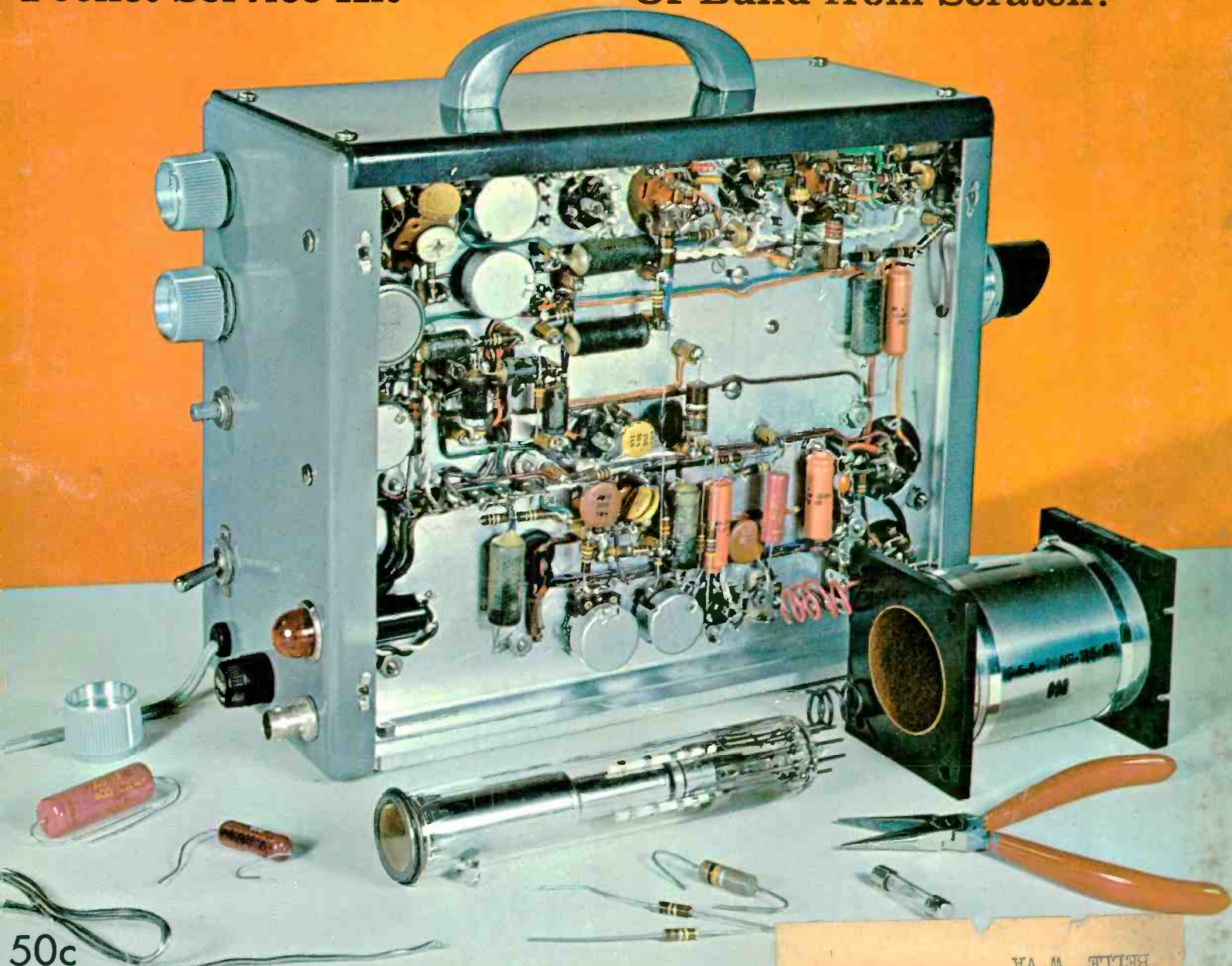

50c

Construct Your Own Low-Cost T

A L PRIDDY 6-62
BOX 133 BRANCH RD RT 1
HELIX VA



**3,516,032
facts of life!**

• At Seneca Falls, New York, Ottawa, Ohio, and Fullerton, California—where Sylvania manufactures picture tubes—engineers give Silver Screen 85's hours upon hours of severe performance and life tests. Tubes taken at random from production lines are actually operated in commercial TV sets typical of those your customers own. Additional tubes are placed in specially designed life test racks, where operating conditions are even more severe than in normal receivers. In this way, Sylvania gets all the facts of tube-life. These facts provide the feedback data that are essential to a continuing program of producing top-level quality picture tubes.

• What is the significance of 3,516,032? This is the number of hours of severe life testing to which Silver Screen 85's were subjected in the year 1961! Covering some 120 tube types, these over 3½ million life test hours assure Sylvania and *you* that Silver Screen 85 picture tubes remain second to none in life and sustained top performance. It is your most reliable assurance of no costly callbacks due to premature picture tube failure, or complaints of unsatisfactory picture performance. Remember Sylvania's 3,516,032 hours of quality monitoring—they can mean more profits for you.

Electronic Tubes Division, Sylvania Electric Products Inc., 1740 Broadway, New York 19, N. Y.

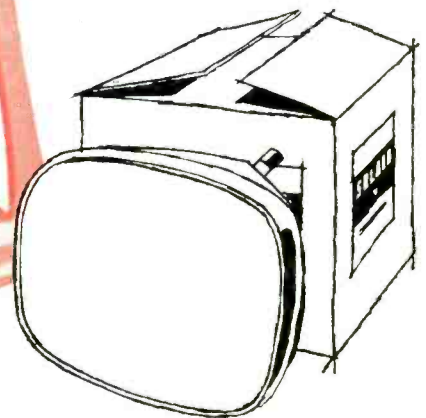

*Sylvania Silver Screen 85—
available wherever there is TV.*

SYLVANIA

SUBSIDIARY OF

GENERAL TELEPHONE & ELECTRONICS





Hermon Scott could make this new kit for \$30 less, If...

Hermon Scott faced a basic choice . . . bring out his new LK-48 amplifier kit at \$124.95 or make it to sell for \$30 less like many other amplifier kits. All his engineering department had to do was make a few compromises.

The LK-48 is rated at 48 watts. By using a smaller power supply, ordinary output transformers, and pushing the output tubes to their limits, the amplifier might still produce 48 watts at 1000 cycles where many amplifier kits are rated. But measured at 20 cycles, where Scott engineers feel power is really important, output would be down considerably. No compromise was made. The LK-48 *actually* produces 28 watts per channel at 20 cycles, and delivers full power throughout the audio range.

Many kits use a one color instruction book. Hermon Scott decided to continue to use full color to insure factory-built performance, even at the hands of a novice.

Important Scott engineering extras like the all-aluminum chassis, DC operated preamp heaters and unique hum-null balancing could have been eliminated. Hum would have been audibly higher and distortion at levels normal to many kits, but Hermon Scott felt that the kit builder was entitled to the same performance he has come to expect from Scott factory-wired units.

Yes . . . Hermon Scott could have made the LK-48 to sell for \$30 less . . . but it would have meant compromising life-long standards. This is something he would never do. You can choose any Scott kit with complete confidence — the LK-48, the LK-72 80 watt complete stereo amplifier, the LK-150 130 watt stereo power amplifier, the LC-21 professional preamplifier, the LT-110 multiplex tuner, LT-10 FM tuner or the LM-35 multiplex adaptor. These superb kits have all the features and performance you've come to expect from the world's leader in audio engineering.

 **H.H. SCOTT**

H. H. SCOTT INC., 111 Powdermill Rd., Maynard, Mass. Dept. 570-05

Please rush me your new full-color brochure telling about Scott's full line of superb stereo kits.

Name

Address

City State

Export: Morhan Exporting Corp., 458 Broadway, N.Y.C.
Canada: Atlas Radio Corp., 50 Wingold Ave., Toronto.
Prices slightly higher West of Rockies.

Radio-Electronics

MAY 1962
VOL. XXXIV No. 5

Formerly RADIO CRAFT — Incorporating SHORT WAVE CRAFT—TELEVISION NEWS—RADIO & TELEVISION*

editorial

Hugo Gernsback 31 Closed Circuit TV Advances

television

Larry Steckler 43 Tube Layouts in TV Sets
Zenith 1961-1962

W. E. Parker 48 TV Camera You Can Build (Cover feature)
Only six tubes in this home-made instrument

Jack Darr 60 Service Clinic
Transmitter Troubles

Dellroye D. Darling 66 High-Voltage Substitution Speeds TV Servicing
Let a raster tell why the set has no raster

David W. Cramp 77 The Marvelous Automatic Tube Bopper

audio—high fidelity—stereo

Norman H. Crowhurst 36 Circuits for FM Stereo
Sherwood, Pilot, Knight and Lafayette

47 New Idea in Tape Recorders

James Maskasky 64 Put More On Your Tape
Squeeze three channels onto one track

radio

Donald L. Stoner 41 License-Free Radio Control
It's right in the FCC regulations

Joseph Marshall 52 FM Tuner With a Twist
Novel circuitry in the Dynatuner

Warren Roy 55 Replacing Japanese Transistor Radio Batteries

Stanley Leinwoll 62 SW Propagation Forecast
April 15-May 15

Dave Stone 78 Electronic Key
It makes dots and dashes

industrial electronics

Leo Lazarus 39 Industrial Technician's Pocket Kit
Seven pieces of very portable industrial test equipment

Ed Bukstein 80 Industrial Electronics Dictionary
From ultrasonics to X-ray tube

Howard T. Bailey 82 All-Transistor Motor Control Relay
Bridge-Circuit input controls shaded-pole motors

what's new

51 Pictorial reports of new developments

test instruments

Robert G. Middleton 45 Power Measurements With Your Scope
What you can learn from the power waveform

Forrest H. Frantz, Sr. 56 Measure Dc Millivolts With a Dc-Ac Converter
Make this gadget and convert your vtvm into a millivoltmeter

L. A. James 70 Variable-Voltage Transformer

Henry Levine 74 Tool-Box Signal Injector
Equipment Report: The Metrex Genie—50 cycles to 3.3 mc

electronics

Tom Jaski 32 Sun-Tracking Robot Furnace Uses Servo Amplifier
This device follows the sun

Elmer Carlson 58 Making Twisted Cable

58 What's Your EQ?
Answers to April puzzles on page 68

James A. Fred 71 Build a Kit?? or Build from Scratch?
Pros and cons help you decide

the departments

93 Corrections

22 Correspondence

106 New Books

88 New Business Getters and
New Literature

90 New Patents

83 New Products

94 New Tubes & Semiconductors

6 News Briefs

100 Noteworthy Circuits

91 Technicians' News

97 Technotes

105 Try This One

102 50 Years Ago

Over 50 Years of Electronic Publishing

EDITOR-IN-CHIEF AND PUBLISHER
Hugo Gernsback

EDITOR

M. Harvey Gernsback

MANAGING EDITOR

Fred Shunaman

TECHNICAL EDITOR

Robert F. Scott, W2PWG

ASSOCIATE EDITOR

Larry Steckler

EDITORIAL ASSOCIATE

I. Queen

SERVICE EDITOR

Jack Darr

TECH. ILLUSTRATION DIRECTOR

Wm. Lyon McLaughlin

ART ASSOCIATE

Fred Neinast

DIRECTOR OF PRODUCTION

Elizabeth Stalcup

DIRECTOR, ADVERTISING SALES

Lee Robinson

EASTERN SALES MANAGER

John J. Lamson

CIRCULATION MANAGER

G. Aliquo

DIRECTOR, NEWSSTAND SALES

Joseph L. Bund

PROMOTION MANAGER

Robert Fallath



Average Paid Circulation
Over 160,000

—on the cover—

(Story on page 48)

You can build this electronic baby sitter yourself. It's a closed-circuit TV camera that requires only six tubes. You'll find a thousand things to do with it.

Color original by W. E. Parker

Gernsback Publications, Inc.

EXECUTIVE, EDITORIAL, ADVERTISING OFFICES

154 W. 14 St., New York 11, N.Y.
Telephone AL 5-7755

CHAIRMAN OF THE BOARD

Hugo Gernsback

PRESIDENT

M. Harvey Gernsback

SECRETARY

G. Aliquo



Radio-Electronics is indexed in
Applied Science & Technology Index
(Formerly *Industrial Arts Index*)

*Trademark registered U. S. Pat. Office

GET YOUR ELECTRONICS-TV-RADIO HOME TRAINING FROM N.T.S. RESIDENT SCHOOL

BREAK THROUGH TO HIGHER PAY, GREATER JOB SECURITY

START NOW! Break through the Earning Barrier that stops "half-trained" men. N.T.S. "All-Phase" Training prepares you . . . at home in spare time . . . for a high-paying CAREER as a MASTER TECHNICIAN in Electronics — TV — Radio. One Master Course at One Low Tuition trains you for unlimited opportunities in All Phases: Servicing, Communications, Preparation for F.C.C. License, Broadcasting, Manufacturing, Automation, Radar and Micro-Waves, Missile and Rocket Projects. A MORE REWARDING JOB . . . a secure future . . . a richer, fuller life can be yours! As an N.T.S. MASTER TECHNICIAN you can go straight to the top in industry . . . or open your own profitable business.

Over 1 City Block of Modern School Facilities, Laboratories and Shops Housing Over 1,000 Students.

50,000 Graduates — all over the World — since 1905

BETTER . . . MORE COMPLETE . . . LOWER COST . . . WITH NATIONAL SCHOOLS' SHOP-METHOD HOME TRAINING!

BETTER . . . Training that is proved and tested in N.T.S. Resident School shops and laboratories, by a School that is the **OLDEST** and **LARGEST** of its kind in the world.

MORE COMPLETE . . . You learn **ALL PHASES** OF Television — Radio — Electronics.

LOWER COST . . . Other schools make several courses out of the material in our **ONE MASTER COURSE** . . . and you pay more for less training than you get in our course at **ONE LOW TUITION!**

NATIONAL TECHNICAL SCHOOLS
WORLD-WIDE TRAINING SINCE 1905

THE SCHOOL BEHIND YOUR HOME-STUDY TRAINING



In these modern School Headquarters your Home Training is: Classroom-Developed, Lab-Studio Planned, Shop-Tested, Industry-Approved, Home Study-Designed.

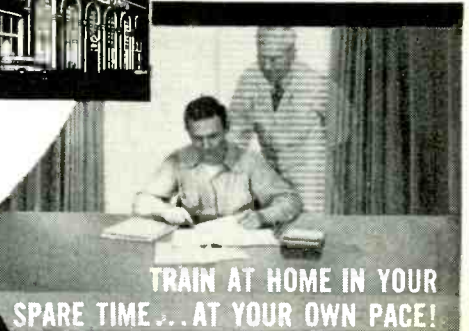
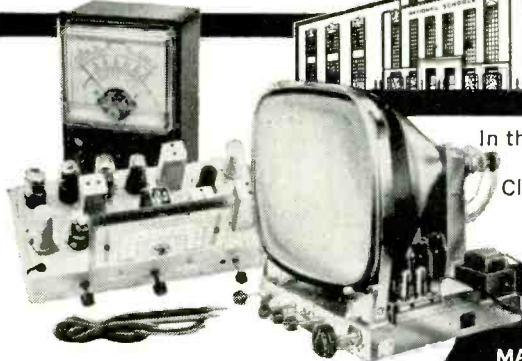

TRAIN AT HOME IN YOUR SPARE TIME . . . AT YOUR OWN PACE!

19 BIG KITS YOURS TO KEEP

- Friendly Instruction and Guidance
- Graduate Advisory Service
- Unlimited Consultation
- Diploma Recognized by Industry
- **EVERYTHING YOU NEED FOR SUCCESS**

N.T.S. IS NOT JUST A MAILING ADDRESS ON A COUPON
N.T.S. is a real school . . . a world famous training center since 1905. Thousands of men from all over the world come to train in our shops, labs, studios and classrooms.

You learn quickly and easily the N.T.S. Shop-Tested way. You get lessons, manuals, job projects, personal consultation from instructors as you progress. You build a Short-Wave, Long-Wave Superhet Receiver plus a large screen TV set from the ground up with parts we send you at no additional cost. You also get a Professional Multitester for your practical job projects. The Multitester will become one of your most valuable instruments in spare time work while training, and afterwards, too. Many students pay for their entire tuition with spare time work. You can, too . . . we show you how.

**SEND FOR INFORMATION NOW . . . TODAY!
IT COSTS YOU NOTHING TO INVESTIGATE**

After you graduate you can open your own TV-Radio repair business or go into high paying jobs like these: Communications Technicians, Hi-Fi, Stereo and Sound Recording Specialists, TV-Radio Broadcasting Technician, Technician in Computers & Missiles, Electronics Field Technician, Specialist in Micro-Waves and Servomechanisms, Expert Trouble Shooter, All-Phase Master Technician, TV-Radio Sales, Service and Repair.

RESIDENT TRAINING AT LOS ANGELES
If you wish to take your Electronics-TV-Radio training in our famous Resident School in Los Angeles — the oldest and largest school of its kind in the world — write for special Resident School catalog and information, or check special box in coupon.

MAIL COUPON NOW FOR FREE BOOK & ACTUAL LESSON

No obligation.
No salesman will call.

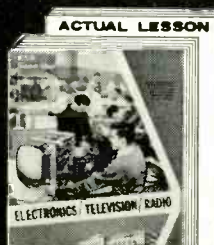

ACCREDITED MEMBER

NATIONAL TECHNICAL SCHOOLS
WORLD-WIDE TRAINING SINCE 1905

4000 SO. FIGUEROA ST., LOS ANGELES 37, CALIF., U. S. A.

NATIONAL TECHNICAL SCHOOLS
WORLD-WIDE TRAINING SINCE 1905

Mail Now To
National Technical Schools, Dept. RG-52
4000 S. Figueroa St., Los Angeles 37, Calif.
Please rush FREE Electronics-TV-Radio "Opportunity" Book and Actual Lesson.

Name _____ Age _____
Address _____
City _____ Zone _____ State _____

Check here if interested ONLY in Resident Training at Los Angeles.
VETERANS: Give date of discharge _____

News Briefs

FCC May Charge License Fees

The FCC proposes a charge for licenses and other regulatory functions. Suggested rate schedule calls for \$150 for new commercial broadcast stations or major changes in existing AM and FM stations, and \$250 for similar TV applications. For TV translators and other broadcast applications, the fee would be \$30. Safety and special radio services would be charged \$5 for amateur and disaster services, and \$20 for all other special radio services. Charges for common-carrier applications would range from \$10 to \$150. A \$20 fee is proposed for experimental-service applications.

The commission also suggests \$2 to \$5 fees for commercial radio operator exams and licenses.

Atomic-Powered Weather Station Installed in Arctic

The world's first atomic-powered automatic weather station is now operating at Sherwood Head on Axel Heiberg Island in the Arctic. The original site was to have been Graham Island, but ice and shoals prevented landing the apparatus there. The new location is some 60 miles farther north.

The station transmits temperature, barometric pressure and wind speed every 3 hours.

Power for the station comes from pellets of a strontium-90 compound that generates heat spontaneously by radioactive decay. A se-

ries of thermocouples turns the heat into electrical energy, which is stored in rechargeable batteries to operate the intermittently transmitting equipment. The data are transmitted on 3.4 and 5 mc simultaneously. The total transmission takes only 9 seconds every 3 hours. Output is 250 watts on each frequency. The picture shows the artist's concept of the station as installed, probably a much more detailed and satisfactory picture than could have been obtained by actual photography.

"Discrete" Is Discreet

For secret communications, the University of Michigan announces the "discrete frequency synthesizer" developed by its Cooley Electronics Laboratory under the leadership of Thomas W. Butler, Jr. Ph.D.

Through a process known as "pseudo-random generation," both receiver and transmitter jump from frequency to frequency, apparently at random, but actually following a computer-designed pattern. Eavesdropping is rendered impossible.

The tuning mechanism consists of a diode that varies capacitance, allowing frequency changes up to 500,000 times per second with a high degree of accuracy—1 part in 100,000,000. Only a single crystal is required, as the diode generates a large number of harmonics. The device is built of solid-state components and contains no moving parts.

The "discrete frequency synthesizer," says Dr. Butler, should

be particularly useful in air navigation systems.

Translator Concern Proposes Cutting TV Audio

A change in the aural-visual power ratio in low-power transmitters has been recommended to the FCC as a means of fostering expanded use of uhf television channels. According to Adler Electronics Inc., who made the proposal, this would make a considerable saving in lower-powered transmitters, which can use a common amplifier for both visual and aural, and would also eliminate the costly diplexer. Experiments with a visual-to-aural power ratio of 4 to 1 and even higher have not brought forth a single reported instance of reduced coverage area, whereas, with the present 2-to-1 ratio, the aural signal coverage is greater than the visual at both vhf and uhf. Other suggestions for cutting costs in low-power stations such as those used for television translators were elimination or reduction of the requirements of vestigial sideband suppression, elimination of restrictions on antenna directivity, provision for remote control, and elimination of the current uhf channel assignments.

Radio Waves Measure Ice

The Army Signal Corps has measured the depth of a massive glacier with a new radio-sounding technique. Amory H. Waite, Jr., veteran engineer of the Research and Development Lab, reports that the soundings were made on Brae Glacier, 20 miles south of Ellsmere Island in the far-north region of Canada.

The method works this way: radio signals penetrate the depth of the glacier and return to a receiver, after reflecting off underlying soil, rock or water. Traveling time of the signal (about 93,000 miles per second—approximately half the free-

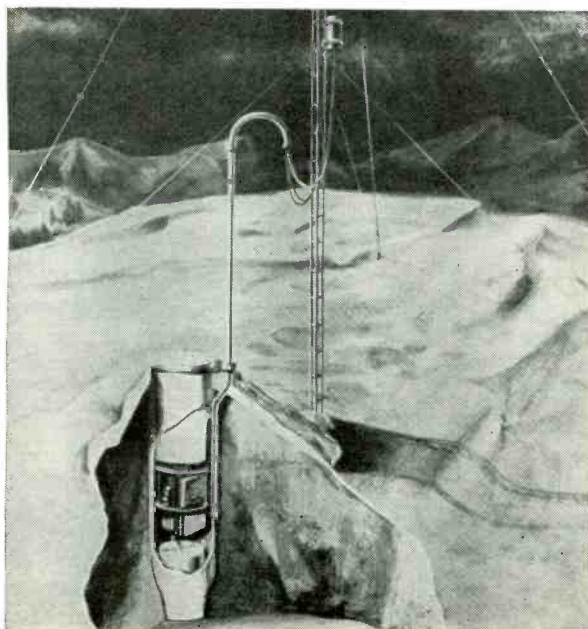

Advertising Representatives: Los Angeles: Harber-Husted-Coughlin, 408^{1/2} South Alvarado St., Tel. DUinkirk 7-2328. San Francisco: Harber-Husted-Coughlin, 444 Market St., Tel. GARfield 1-0151. Atlanta: J. Sidney Crane & Associates, 22 Eighth St. N.E., Tel. TRinity 2-6720. Florida: Neff Associates, 15 Castle Harbor Isle, Fort Lauderdale, Fla. United Kingdom: Publishing & Distributing Co., Ltd., Mitre House, 177 Regent St., London, W. 1, England.

Foreign Agents: Great Britain: Atlas Publishing and Distributing Co., Ltd., 18 Bride Lane, London E.C. 4.

Subscription Service Address form 3579 and correspondence to Radio-Electronics, Subscriber Service, 154 West 14th St., New York 11, N.Y. When requesting a change of address, please furnish an address label from a recent issue. Allow one month for change of address.

NOW...PREPARE FOR A CAREER IN...

Radio • Television • Radar • Space & Missile

or other branch of **ELECTRONICS**

FASTER!



Prepare in Spare Time
at Home, or in
Chicago or Toronto
Laboratories

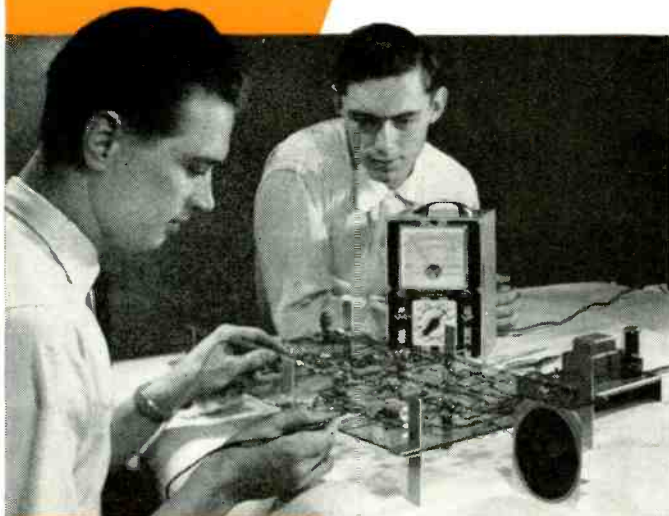

Would you like to become a well-paid technician with a missile firm? Or, perhaps you'd rather work in Radio-Television . . . Broadcasting . . . Automation . . . Communications . . . Radar . . . Microwaves . . . Industrial Electronics . . . or other exciting field.

Any of these careers is possible **SOONER THAN YOU MAY THINK** when you have a skill to offer — the kind you get by training the DeVry Way.

If you prepare at home, you use time-saving, up-to-date **TEXTS**, training **FILMS** and **PROJECTOR**, plus valuable **electronic EQUIPMENT**. You get practical experience with DeVry's Electro-Lab system that lets you perform many learn-by-doing projects quickly with practically no soldering. Little wonder DeVry men get ready **IN A MINIMUM OF TIME** with such tested methods to rely on!

Thousands of men today hold good-paying jobs as a result of this program that is designed to get you to the job opportunities sooner. **SEND COUPON TODAY** for full facts.

Home Movies...
are a DeVry exclusive. They save you hours of reading, help you grasp basic ideas faster.

**MEN
17-55**
No advanced education or previous technical experience required.

YOU MAY OWN YOUR OWN SHOP

DeVry-trained men face many opportunities, including their own profitable service shops. This is an ideal way to go into business for yourself.

EMPLOYMENT SERVICE

There is no extra charge for help from DeVry's efficient Employment Service.

MEN FACING MILITARY SERVICE

We have important facts for the man about to enter the armed forces. **SEND COUPON NOW.**



**SEND FOR 2 FREE BOOKLETS
MAIL COUPON TODAY!**

DeVRY TECHNICAL INSTITUTE
4141 Belmont Ave, Chicago 41, Ill., Dept. RE-5-5

Please give me your two free booklets, "Pocket Guide to Real Earnings" and "Electronics in Space Travel"; also include details on how to prepare for a career in Electronics. I am interested in the following opportunity fields (check one or more):

<input type="checkbox"/> Space & Missile Electronics	<input type="checkbox"/> Communications
<input type="checkbox"/> Television and Radio	<input type="checkbox"/> Computers
<input type="checkbox"/> Microwaves	<input type="checkbox"/> Broadcasting
<input type="checkbox"/> Radar	<input type="checkbox"/> Industrial Electronics
<input type="checkbox"/> Automation Electronics	<input type="checkbox"/> Special "Short Courses"

Name _____ Age _____
Address _____ Apt. _____
City _____ Zone _____ State _____

Check here if you face military service.
Canadian residents: Write DeVry Tech of Canada, Ltd.,
2080 970 Lawrence Avenue West, Toronto 19, Ontario

Accredited member of National Home Study Council

DeVRY TECHNICAL INSTITUTE
CHICAGO • TORONTO

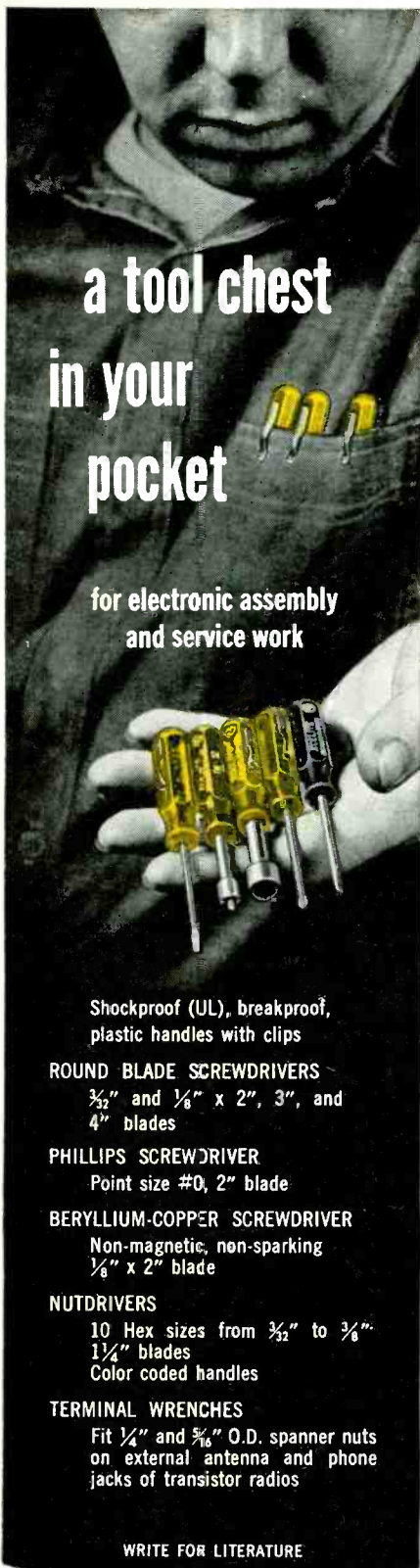

a tool chest
in your
pocket

for electronic assembly
and service work

Shockproof (UL), breakproof,
plastic handles with clips

ROUND BLADE SCREWDRIVERS
3/32" and 1/8" x 2", 3", and
4" blades

PHILLIPS SCREWDRIVER
Point size #0, 2" blade

BERYLLIUM-COPPER SCREWDRIVER
Non-magnetic, non-sparking
1/8" x 2" blade

NUTDRIVERS
10 Hex sizes from 3/32" to 3/8"
1 1/4" blades
Color coded handles

TERMINAL WRENCHES
Fit 1/4" and 3/16" O.D. spanner nuts
on external antenna and phone
jacks of transistor radios

WRITE FOR LITERATURE



**PROFESSIONAL
POCKET TOOLS**

XCELITE, INC. • ORCHARD PARK, N. Y.
Canada: Charles W. Peinton, Ltd., Toronto, Ont.

space velocity) tells operators how deep the glacier is.

The Army Signal Corps technique has been used in measuring ice gaps, but it was thought that the greater movement of glaciers might deflect signals from their course and upset readings. No serious disruptions were observed, however.

Radio sounding is faster and less expensive than the older method of seismic sounding, which involves explosives and highly trained personnel. The work is also being carried on in the Antarctic, and will provide a clearer picture of geographical features hidden by ice in these areas.

FM Sets New Record

Purchases of FM radio receivers exceeded 2,500,000 in 1961, surpassing 1960's former record by 450,000 sets. FM stations have also increased, numbering 1,162 as of mid-February, 1962. A part of this increase represents a steady gain in FM which was beginning in late 1958 and has continued to increase up to the present. Accelerating factors are the entry into the field of FM stereo and the development of FM automobile and portable radios, first imported from abroad and now being made in the United States as well.

Writer Wins Edison Award

Amateur radio operator William G. Welsh, 34, of Cambridge, Mass., and Burbank, Calif., has received General Electric's 1961 Edison Radio Amateur Award for public service. In addition to the award trophy, he received a \$500 cash prize.

Employed as an electronics engineering writer by Raytheon Corp., Waltham, Mass., and more recently by Librascope, Inc., Glendale, Calif., Welsh operates amateur radio station W1SAD/6 and uses his spare time to teach electronics. He is said to have devoted 20 to 30 hours a week to this endeavor over the past 10 years, giving free instruction to about 2,800 persons.

His courses include eight 1,800-

foot code practice tapes, which he has run off free of charge and distributed to voluntary study groups throughout the nation and in at least 12 foreign countries.

Nominated by various persons in the Boston area, Welsh was chosen from 23 candidates as the tenth winner of this award.

Special citations also went to runners-up Robert T. Herndon, Port Lavaca, Texas; Eugene M. Link, Boulder, Colo.; and George L. Thurston, Tallahassee, Fla.

Lucien Chretien Passes

Lucien Chrétien, electronics editor of the magazine *Radio et TV* (formerly *La TSF pour Tous*) for more than 30 years, has died in Paris. In addition to his work as editor, he was the author of a number of texts on radio, television and electronics, an instructor (Ingénieur de l'Ecole Supérieure d'Electricité) an inventor, and a technical journalist since 1917.

Doppler Navigators To Take Over in Air?

Aerial navigators on TWA's overseas jetliners may soon be replaced by Doppler radar sets and analog computers.

The human navigator accomplished his task with radio aids, dead reckoning and a periscopic sextant for celestial observation. Limitations of this method demanded a longer and wider block of air space for each flight. The new system, far more accurate, permits sharp reduction in ocean air-space assignments.

The TWA cockpit now contains a side-by-side pair of ground speed and drift indicators (A and B), each preset to give guidance for the first two segments of the trip—about 500 miles each. The pilot then sets A for the third segment, and the units overtake each other in leapfrog fashion for the rest of the journey.

These computer-run units are adjusted by turning knobs to the preselected course and mileages supplied to the pilot before flight time.

Welsh Aids
Future
Technicians

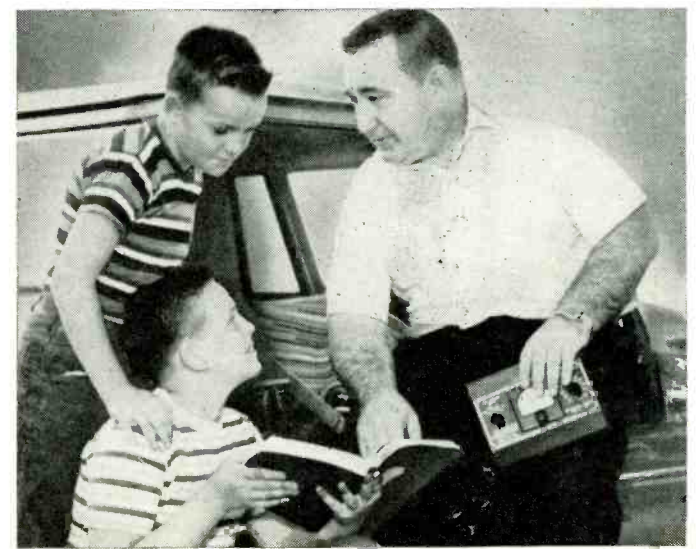

In All the World Never a Kit Value Like This

FM STEREO BY **knight-kit**[®]

ONLY **\$19⁹⁵**
NO MONEY DOWN

**STEREO FM
MULTIPLEX KS-10A
ADAPTER KIT**



a pleasure
to build...
a revelation
in performing
quality

enjoy beautiful Stereo FM reception at unbelievably low cost

**IDEAL FOR USE WITH ANY FM OR FM-AM
TUNER WITH MULTIPLEX OUTPUT JACK**

PROOF OF SUPERIOR VALUE

- Self-powered—installs out of sight • Separation control for precise stereo adjustment (23 db separation) • Input sensitivity 0.2 volts • Frequency response 50-15,000 cps, ±1 db • Noise filter (switchable) for use in weak signal areas • Top-performing circuit using 2 dual and 1 triple-purpose tubes • Power supply is transformer-operated; uses selenium rectifier • Pi-filter network for ripple-free B+ voltage — hum is practically inaudible • Prealigned coils • AC on-off switch • Three 36" connecting cables included.

Simply plugs into your tuner's Multiplex output and your amplifier's tuner inputs. With all connecting cables, tubes, parts, and famous Knight-Kit step-by-step instructions. 3 $\frac{3}{8}$ " x 8 $\frac{1}{2}$ " x 4". For 110-125 v. 60 cycle AC. Shpg. wt., 4 lbs.

.....
*typical of the value and quality of over
100 other great KNIGHT-KITS*

**KNIGHT ELECTRONICS DIVISION
ALLIED RADIO**

Now you can have the pleasure of an easy kit-building experience. Now you can enjoy all the tonal beauty and realism of Stereo FM broadcasts just by adding this quality Knight-Kit Multiplex adapter to your present stereo music system. The savings simply can't be duplicated. The quality can't be matched for anywhere near the price. Order the KS-10A Knight-Kit Multiplex adapter today—*no money down* (just check coupon). An unbeatable value at only . . . **\$19⁹⁵**

Satisfaction guaranteed or your money back

ORDER TODAY **ALLIED RADIO,**
100 N. Western Ave., Chicago 80, Ill.

Ship me KS-10A Knight-Kit Multiplex Adapter(s) 83YX656G

Ship on Allied's Credit Fund Plan—no money down

\$..... enclosed (check) (money order)

Name _____

Address _____

City _____ Zone _____ State _____

Outperforms them all! Outsells them all!

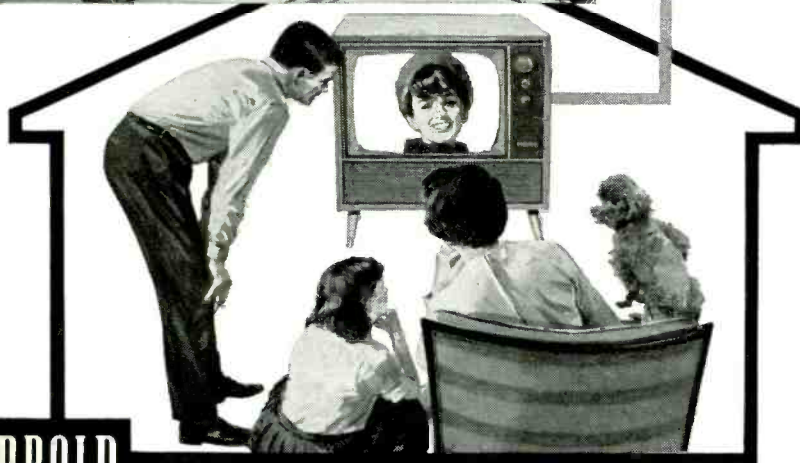
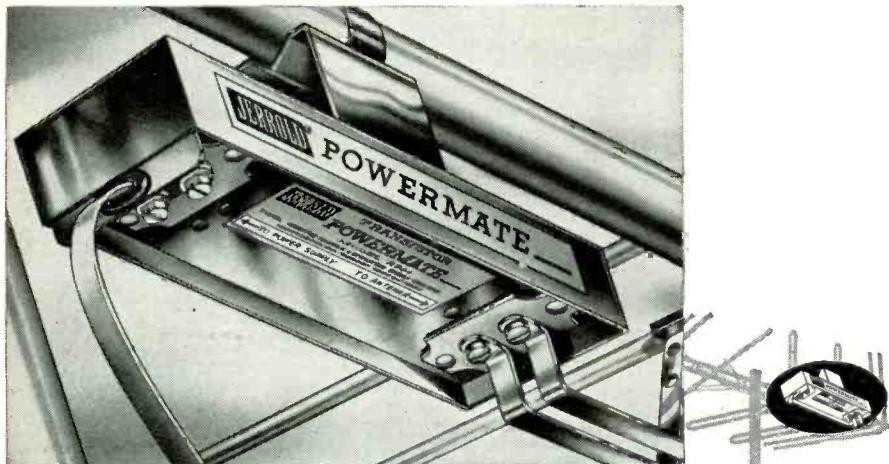

JERROLD®

TRANSISTOR POWERMATE PREAMPLIFIER

BY FAR THE BEST antenna preamplifier in the business—that's POWERMATE! On black-and-white, and where it *really counts*—on color TV—POWERMATE's superiority shows up across the country.

The better VSWR (impedance match), flat response, ultra-high gain, special broad-band neutralizing transformer, and better power-supply filtering—all add up to an outstanding product. No polarity problems . . . no call-backs . . . transistor protected from lightning-coupled surges . . . remote a-c power supply feeds 2 sets.

Step up to POWERMATE, and step up to a tremendous new profit opportunity. See your Jerrold distributor now.

Model APM-101 \$39.95 list, complete

JERROLD ELECTRONICS CORPORATION

Distributor Sales Division, Dept. IDS-221, Philadelphia 32, Pa.
Jerrold Electronics (Canada) Ltd., Toronto • Export: CBS International, New York 22, N. Y.



A vertical bar informs the pilot that he is on course or specifies the number of miles off course. A drift-angle pointer indicates the amount of heading correction necessary to compensate for crosswinds.

Barber-pole alarm flags in the indicator windows tell the pilot when the Doppler system is not working due to microwave signals glancing off the ocean's surface.

Although TWA officials say the system is "fantastically accurate," the FAA requires the use of ground-based radio aids to confirm positions, at least for the present.

Calendar of Events

IRE-AIEE Symposium on Mathematical Theory of Automata, April 24-26, United Engineering Center, New York, N. Y.

NATESA Directors Spring Conference, Apr. 28-29, Americana Hotel, Miami, Fla.

SMPT 91st Convention, April 29-May 4, Ambassador Hotel, Los Angeles, Calif.

IRE, AIEE Spring Joint Computer Conference, May 1-3, Fairmont Hotel, San Francisco, Calif.

IRE International Congress on Human Factors in Electronics, May 3-4, Lafayette Hotel, Long Beach, Calif.

IRE, AIEE, EIA Electronic Components Conference, May 8-10, Marriott Twin Bridges Hotel, Washington, D. C.

IRE National Aerospace Electronics Conference, May 14-16, Biltmore Hotel, Dayton, Ohio.

Institute for Advancement of Medical Communication Council on Medical TV, May 15-16, National Institutes of Health, Bethesda, Md.

Navy Medical Dental TV Workshop, May 16-17, National Naval Medical Center, Bethesda, Md.

1962 Electronic Parts Distributors Show, May 21-24, Conrad Hilton Hotel, Chicago. Attendance limited to manufacturers, distributors, representatives and their advertising agencies. RADIO-ELECTRONICS will exhibit in Room 610.

ISA National Aero-space Instrumentation Symposium, May 21-23, Marriott Twin Bridges, Motor Hotel, Washington, D. C.

IRE, AIEE, ASME, ISA National Telemetering Conference, May 23-25, Sheraton Park Hotel, Washington, D. C.

EIA Annual Convention, May 23-25, Pick-Congress Hotel, Chicago, Ill.

IRE Seventh Region Space Communications Conference, May 24-26, Seattle, Wash.

IRE Spring Conference on Broadcast and TV Receivers, June 18-19, O'Hare Inn, Chicago.

Not All Recruiters Welcome Women Engineers

Despite the statement of Mildred Webber, placement official at the University of Michigan (RADIO-ELECTRONICS, April, 1962, page 12), who said that "women have just as good a chance as men in any science field, and can earn comparable salaries," a survey of personnel recruiters from 30 of the nation's largest (Continued on page 16)

The only electronics home study program that guarantees*... **A Commercial FCC License** **...Or Your Money Back!**

No other electronics home study program can equal that offered by Cleveland Institute. And that's why we make this exclusive guarantee:

*Completion of our Master Course prepares you for a First-Class Commercial Radio Telephone License with a Radar Endorsement. If you fail the FCC examination for this license after successfully completing the Master Course, you will receive a full refund of all tuition payments. This guarantee is valid for the entire duration of your enrollment period.

This Course Is Designed Specifically For Men With Previous Electronics Training or Experience and Provides...

- Advanced electronic theory and math. (You will receive a special 10" Electronic Slide Rule and complete instructions).
- Special training in the practical application of electronics skill in such advanced fields as Computers . . . Servo-Mechanisms . . . Magnetic Amplifiers . . . AC Circuit Analysis . . . Pulse Circuitry . . . Color TV . . . Radar . . . Advanced Measuring Techniques . . . Industrial Electronics . . . Instrumentation . . . Automation . . . Radio Telemetry . . . Semiconductors.



Get This Handy Pocket Electronics Data Guide Free . . .

Conversion factors, formulas, tables and color codes at your fingertips. Yours without obligation, simply for responding NOW to this opportunity to improve your future.

Send This Coupon Today →

Cleveland Institute of Electronics

1776 E.17 St., Desk RE-65, Cleveland 14, O.

Accredited by the Accrediting Commission of the National Home Study Council
 (An Accrediting Commission Approved by the U. S. Office of Education).



Three Free Booklets Tell How CIE Training Opens The Door To Unlimited Opportunities

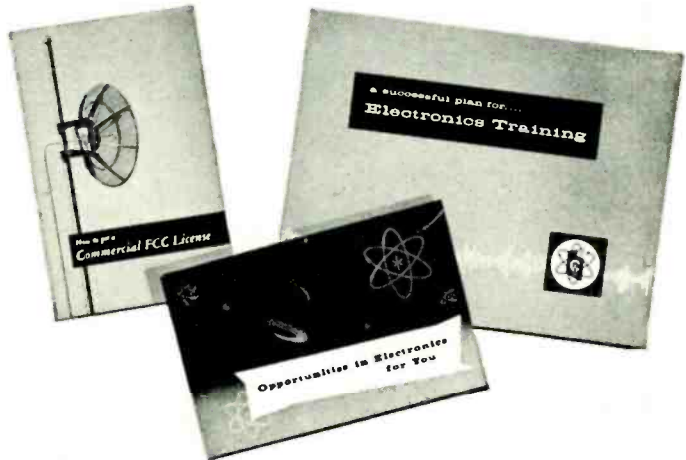

More Reasons How CIE Will Help You Get Ahead in Electronics

Job Service . . . every month, for three years, CIE will supply you with a listing of hundreds of job opportunities. High paying, interesting jobs . . . with top companies throughout the world. See how CIE training opens a whole new world in electronics opportunity.

Electron Bulletin . . . every month, every student receives a free copy of this informative bulletin. Keeps you up to date on what's going on in electronics.

I want to know more about your electronics home study training program. Please send me your free booklets described above plus your handy pocket Electronics Data Guide. I understand there is no obligation. I have had training or experience in electronics as indicated.

Mail Coupon To

Cleveland Institute of Electronics
 1776 E. 17th St., Desk RE65, Cleveland 14, Ohio

- | | |
|---|---|
| <input type="checkbox"/> Military | <input type="checkbox"/> Amateur Radio |
| <input type="checkbox"/> Radio-TV Servicing | <input type="checkbox"/> Broadcasting |
| <input type="checkbox"/> Manufacturing | <input type="checkbox"/> Home Experimenting |
| <input type="checkbox"/> Communications | <input type="checkbox"/> Other |

I'm now working in _____

I want to know about the following area of electronics _____

(please print)

Name _____ Age _____

Address _____

City _____ Zone _____ State _____

RE-65



P. R. MALLORY & CO. Inc.
MALLORY

Tips for Technicians

Distributor Division, P. R. Mallory & Co. Inc.
P. O. Box 1558, Indianapolis 6, Indiana

Rectifier "packages" save time and space

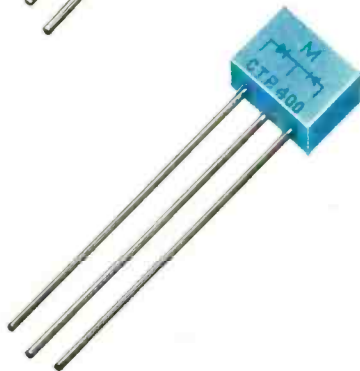
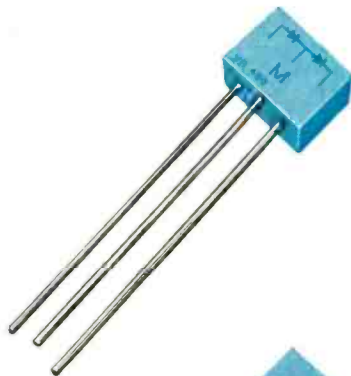

When you're putting together a DC power supply, these little Mallory packaged rectifier circuits can spark a lot of time-saving, space-squeezing ideas.

Each package is a complete rectifier circuit . . . bridge, doubler or center-tap . . . that does the job of two or four separate rectifiers. So you've only got *one* component to wire in place. The individual rectifier cells are factory-connected in the package.

You can get the exact rectifier you want in this compact form. And we mean compact. Less than $\frac{3}{4}$ " by $\frac{1}{2}$ ", and $\frac{1}{4}$ " thick. Cold case design, too; you can mount 'em anywhere without worrying about case-to-ground shorts.

PRV ratings on all three types go as high as 600 volts. And there's plenty of current capacity. The FW full wave bridge models are rated 1.5 amps. DC at 50°C. ambient, 1.0 amp. at 100°C. Doubler Type VB and center tap Type CT are rated 0.75 amp. at 50°C., 0.5 amp. at 100°C.

If you need more current rating, you can parallel the two sides of the type CT package, using 0.5-ohm equalizing resistors in series with each leg. And you can get a high PRV unit at low cost by using a type VB double package as a series-connected half-wave rectifier, connecting a one-megohm resistor across each cell for voltage equalization.

As if all this weren't enough, you save money, too, because our packaged circuits cost less than individual rectifiers. Get them from your Mallory Franchised Distributor. He's a good man to call on for Mallory capacitors, switches, controls, batteries, resistors and vibrators . . . and for any other components you need.

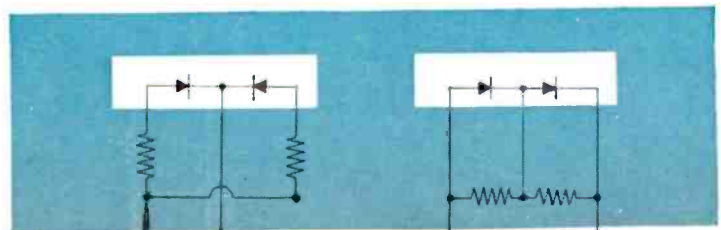

The Same School That Originated The RTS BUSINESS PLAN

...NOW
Proudly
Presents...

A SPECIAL **COMPACT** COURSE
COVERING ALL THREE PHASES OF

ELECTRONICS

The Entire Course Is Made
Up Of The Following:

- 35 LESSONS COVERING BASIC AND INTERMEDIATE ELECTRONICS
- 9 EQUIPMENT KITS COMPLETE WITH TUBES AND BATTERIES
- SOLDERING IRON
- 25 LESSONS COVERING THESE ADVANCED ELECTRONIC SUBJECTS:
 - Thyratron Tubes • Semiconductors • Electronic Symbols and Drawings • Voltage-Regulators • Electronic-Timers • Control Systems • X-Rays • Photoelectric Devices • Dielectric Heating • Geiger Counters • Pulse Circuitry • Clippers and Limiters • Multivibrators • Electronic Counters • Radar • Magnetic Amplifiers • Analog-Computers • DC Amplifiers • Digital Computers • Storage Systems • Input and Output Devices • Servomechanisms • Telemetering
- 60 EXAMINATIONS
- UNLIMITED CONSULTATION SERVICE
- KIT MANUALS
- DIPLOMA UPON GRADUATION

BASIC • INTERMEDIATE • ADVANCED
DESIGNED FOR THE BUSY MAN OF TODAY

This is MODERN training for the MODERN man. You'll find no "horse and buggy" methods here. Every page of this streamlined course is devoted to important Electronics principles and practical projects. You'll be amazed how fast you grasp Electronics the RTS way. RTS has combined modern THEORY and PRACTICE to make this the finest training program of its kind available!

SATISFIES NOVICE, TECHNICIAN OR HOBBYIST

Whether you're new to Electronics or an old "pro," chances are you'll find this to be the ideal course for you. The novice will appreciate the completeness of the training. It starts with the most basic considerations, covering each important point thoroughly, yet concisely. The technician will enjoy the practical review of fundamentals and profit from the 25 advanced subjects covered.

RTS GIVES YOU "TOP MILEAGE" FOR YOUR TRAINING DOLLAR

The price quoted below buys EVERYTHING — there are no extras to pay for. RTS has gone "all out" to give you the best training value in America. Why pay hundreds of dollars for training such as we offer when it's available for this LOW PRICE? If you can find a better training bargain... BUY IT!

CAN BE COMPLETED IN MONTHS INSTEAD OF YEARS

Some students will complete this course with "Jet-Like" speed but we allow up to two years if your circumstances require it. You study at your own rate. You are ENCOURAGED but not pushed. You'll find the lessons professionally written but easy to understand. LET US SEND YOU ONE OF THESE LESSONS ALONG WITH YOUR CAREER BOOKLET SO YOU CAN SEE FOR YOURSELF. NO OBLIGATION!

AND MUCH MORE...

RTS' Membership in The Association of Home Study Schools is your assurance of Reliability, Integrity and Quality of Training.



RTS ELECTRONICS DIVISION
815 E. ROSECRANS AVENUE
LOS ANGELES 59, CALIFORNIA

Est. 1922



L 201B

COMPLETE
COST...
INCLUDES ALL KITS,
TUBES, BATTERIES, ETC.
\$125.00*

**Rush
Coupon**

**NO
SALESMAN
WILL
CALL!**

* TERMS ALSO AVAILABLE
AS LITTLE AS

\$500 DOWN \$500 PER MONTH

**SAVE TIME — SEND
\$5.00 WITH COUPON**
YOUR FIRST LESSONS AND
KIT WILL BE RUSHED TO YOU
THE SAME DAY THEY ARE RECEIVED!

DON'T LOSE OUT — FIND OUT!

RTS ELECTRONICS DIVISION, Dept. RE-52

815 E. ROSECRANS AVENUE LOS ANGELES 59, CALIFORNIA

Rush me full information by return mail. (Please Print)

Name _____ Age _____

Address _____

City _____ Zone _____ State _____

ENROLL ME NOW **SEND MORE FACTS**

Now is the time to come to the aid of your ^{outdoor} party!

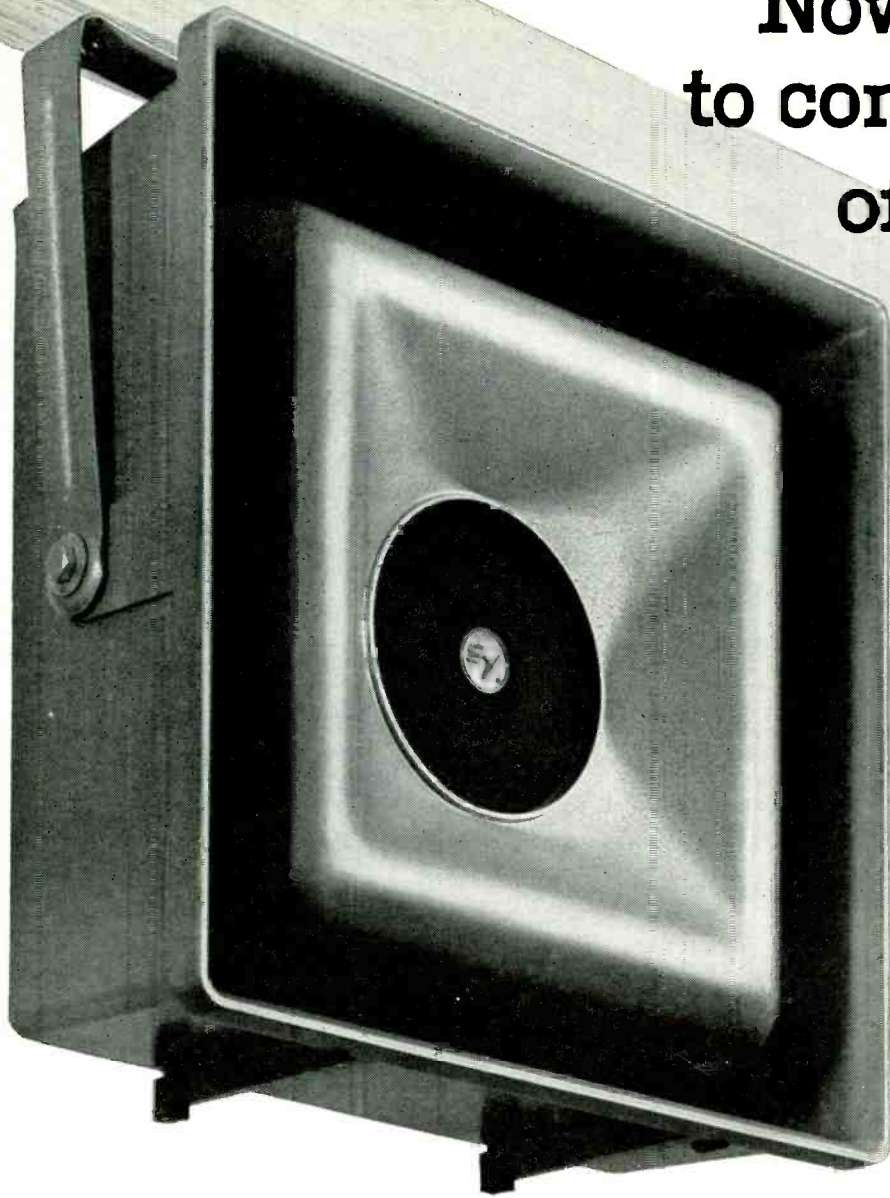

The more you enjoy outdoor living, the more you'll enjoy the Electro-Voice Musicaster—world's finest weather-proof loudspeaker system.

A Musicaster will add to your fun wherever you are. Whether you're dancing under the stars, swimming in the pool, or relaxing around the barbecue in the backyard, music from a Musicaster adds the pleasure of outdoor high-fidelity music from your present Hi-Fi system, radio, phonograph or TV set.

It's easy to connect for permanent use outside, or you can simply move your Musicaster into the recreation room for year-'round pleasure.

Designed for indoor-outdoor use, the E-V Musicaster obtains high-fidelity response from a heavy-duty weather-proofed speaker mounted in a rugged aluminum die-cast enclosure. This combination insures long-lasting satisfaction under all conditions.

Now is the time to come to the aid of your outdoor party . . . with an Electro-Voice Musicaster. It's easy to install . . . send for full information and the name of your nearest E-V sound specialist.

ELECTRO-VOICE High-Fidelity Speaker System . . . it's Weather-proofed!

P.S. If your school, church or club needs a tough, high-quality, all-purpose speaker, the smart choice is an Electro-Voice Musicaster.

SPECIFICATIONS:

Frequency Response: 60-13,000 cps
Dispersion: 120°
Power Handling Capacity: 30 watts program
Impedance: 8 ohms
Size: 21½" H x 21½" W x 8½" D
Weight: 31 lbs. net
Price: \$54.00

Musicaster II available with additional tweeter to extend response to 18,000 cps. Price: \$75.00

Electro-Voice, Inc. Dept. 524E
Buchanan, Michigan
Please send me your booklet, "How to Enjoy High-Fidelity Outdoors."

Name _____

Address _____

City _____ State _____

Electro-Voice®

ELECTRO-VOICE, INC., Consumer Products Division, Buchanan, Michigan

F.C.C. COMMERCIAL OPERATOR LICENSE

Training..

F. C. C. LICENSE — KEY TO BETTER JOBS

An F. C. C. *commercial* (not amateur) license is your ticket to higher pay and more interesting employment. This license is Federal Government evidence of your qualifications in electronics. Employers are eager to hire *licensed* technicians.

WHICH LICENSE FOR WHICH JOB?

The **THIRD CLASS** radiotelephone license is of value primarily in that it qualifies you to take the second class examination. The scope of authority covered by this license is extremely limited.

The **SECOND CLASS** radiotelephone license qualifies you to install, maintain and operate certain radiotelephone equipment but not commercial broadcast station equipment.

The **FIRST CLASS** radiotelephone license qualifies you to install, maintain and operate every type of commercial radiotelephone equipment including all radio and television stations in the United States, its territories and possessions. This is the highest class of radiotelephone license available. Many companies which employ industrial electronics technicians require this license.

GRANTHAM TRAINING PREPARES YOU

The Grantham Communications Electronics Course prepares you for a **FIRST CLASS** F. C. C. license, and it does this by **TEACHING** you electronics. Each point is covered simply and in detail, with emphasis on making the subject easy to understand. The organization of the subject matter is such that you progress, step-by-step, to your specific objective—a first class F. C. C. license.

CORRESPONDENCE OR RESIDENCE CLASSES

Grantham training is available by correspondence or in resident classes. Either way, you are trained quickly and well. Write, or mail the coupon below, to any division of Grantham School of Electronics. Our free booklet will be sent to you immediately.

FOUR SCHOOLS TO SERVE YOU

To better serve our many students throughout the entire country, Grantham School of Electronics maintains four Divisions — located in Hollywood, California; Kansas City, Mo.; Seattle, Wash.; and Washington, D.C.

GRANTHAM SCHOOL OF ELECTRONICS

HOLLYWOOD
CALIF.

1505 N. Western Ave.
Hollywood, Calif. (HO 7-7727)

SEATTLE
WASH.

408 Marion Street
Seattle, Wash. (MA 2-7227)

KANSAS CITY
MO.

3123 Gillham Road
Kansas City, Mo. (JE 1-6320)

WASHINGTON
D. C.

821 - 19th Street, N. W.
Washington, D. C. (ST 3-3614)

This booklet
FREE!



This free booklet gives details of our training and explains what an F. C. C. license can do for your future.

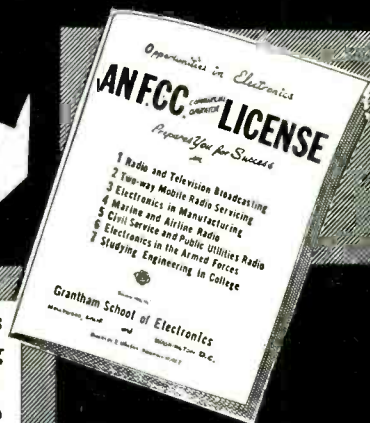

Upgrade Your Income with a First Class F. C. C. LICENSE

HERE'S PROOF... that Grantham students prepare for F. C. C. examinations in a minimum of time. Here is a list of a *few* of our recent graduates, the class of license they got, and how long it took them:

	License	Weeks
James C. Bailey, 217 Behrends Ave., Juneau, Alaska	1st	12
Edward R. Barber, 907 S. Winnifred, Tacoma, Wash.	1st	20
M. A. Dill, Jr., 20 Cherry St., Gardiner, Maine	1st	12
Bernhard G. Fokken, Route 2, Canby, Minn.	1st	12
Kenneth F. Foltz, Broad St., Middletown, Md.	1st	12
James C. Greer, Mound City, Kansas	1st	12
Thomas J. Hoof, 216 S. Franklin St., Allentown, Pa.	1st	22
Clyde C. Morse, 7505 Sharronlee Dr., Mentor, Ohio	1st	12
Louis W. Pavak, 838 Page St., Berkeley 10, Calif.	1st	16
Wayne Winsauer, 2009 B St., Bellingham, Wash.	1st	12

Accredited by the National Home Study Council

MAIL COUPON TO SCHOOL NEAREST YOU

(Mail in envelope or paste on postal card)

To: **GRANTHAM SCHOOL OF ELECTRONICS**
1505 N. Western • 408 Marion • 3123 Gillham Rd. • 821-19th, NW
Hollywood • Seattle • Kansas City • Washington



Gentlemen:

Please send me your free booklet telling how I can get my commercial F. C. C. license quickly. I understand there is no obligation and no salesman will call.

Name _____ Age _____

Address _____

City _____ State _____

I am interested in: Home Study, Resident Classes 24-E

"Loud and clear" reception begins with quality-engineered Sonotone Ceramikes. That's because Ceramikes are designed to give maximum speech intelligibility — designed for greater sensitivity to the frequencies covering the human voice. This frequency selectivity, coupled with physical design, screens out background noises. Ceramikes are inherently immune to extremes of temperature or humidity — will operate even if immersed in water. The ceramic transducer of every Ceramike is neoprene-encased, rendering it shock and impact-proof to withstand rough treatment.

*a
quality trio of
microphones
for "loud & clear"
communications*

There's no secret to Sonotone's ability to combine performance with durability. Sonotone has pioneered research in hearing aids — where transducers must meet the unbelievably critical demands of frequency response and day-in, day-out use and still function dependably. This know-how is responsible for this smartly engineered line-up of microphones tailored to communications requirements.

SONOTONE CERAMIKES

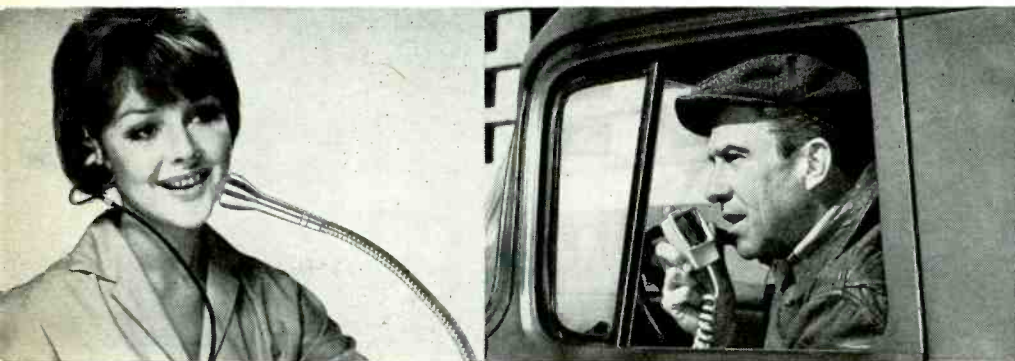

perfect cb team

SONOTONE CERAMIKE CM-30 — Perfect for mobile use. Intelligibility unsurpassed. Sensitivity curve favors voice frequency range. High sensitivity from -49 db from 90 to 6000 cps. Ruggedly built to take the punishment of mobile use. Lightweight, shatterproof plastic case. Easy to handle—and control with convenient "Push-to-Talk" button. Has special dashboard mounting bracket. Supplied with spring-spiraled 4-conductor shielded cable. List \$14.00.

SONOTONE CERAMIKE CM-17A — 13" Flex-mike. Ideal base station microphone for CB or other communications applications. Gooseneck mounting makes it easy to talk while keeping hands free. Sharp, clear communication with frequency response sensitivity of -56 db from 50 to 11,000 cps, ± 2 db. Equipped with 6' shielded cable. List \$24.50.

rugged mobile communications mike

SONOTONE CERAMIKE CM-31 — Budget-priced communications model in shatterproof plastic case features excellent intelligibility (90 to 6000 cps frequency range at -49 db sensitivity). 2-conductor coil cable — no switch. List \$13.50. Fixed communications or mobile, Sonotone Ceramikes provide top-flight, long-term, maintenance-free performance.

SONOTONE® CORPORATION

Electronic Applications Division Elmsford, New York
Canada: Atlas Radio Corp., Ltd., Toronto Cartridges • Speakers
Tape Heads • Mikes • Electron Tubes • Batteries • Hearing Aids

(Continued from page 10)

est defense contractors reveals that 20% are still reluctant to hire women engineers and scientists.

The survey was made by the Research Dept. of Careers Inc., national job information clearing house for scientists and engineers. Since it consisted of interviews with the actual recruiters of some of the

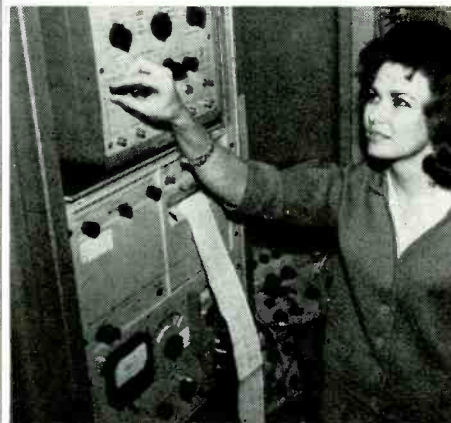

—Army Photo

Engineer Sylvia Welker, with the Signal Missile Support Agency at the White Sands Missile Range, N. M., is a graduate of Virginia Polytechnic Institute. Mrs. Welker, 24, is the youngest of several women engineers at the Range. She holds down a full-time work assignment in the Vulnerability Research and Development Branch of Missile Electronic Welfare Division. In her spare time, she cares for her 14-month-old daughter, works toward her Master's degree at New Mexico State University and studies Russian at a night class.

nation's largest defense contractors, it may perhaps reflect the facts more accurately than the "official" statements of corporation spokesmen.

The question "Are you reluctant to hire women scientists or engineers?" was asked recruiters representing 30 corporations. The answers were "No, not reluctant"—23, "Yes, reluctant"—6.

Electric Power Station Will Use Atomic Energy

The Atomic Energy Commission has issued a permit for a 40,000-kw high-temperature, gas-cooled nuclear power station at Peach Bottom in southeastern Pennsylvania.

The Peach Bottom plant will be built by Philadelphia Electric and 52 other electric utility companies, organized as High Temperature Reactor Development Associates Inc. The 53 companies generate 42% of all the electricity produced by the privately owned power companies of the United States.

The plant is expected to be in operation by mid-1964, and will be operated by Philadelphia Electric as a unit of its 3,500,000-kw power generating system. It will represent the first commercial application of an advanced technique of nuclear power generation known as the high-temperature, gas-cooled power reactor.

(Continued on page 20)



ANOTHER **PRECISION**
SERVICE TIP FOR YOU.

PRECISION PETE

"A CASE OF
DOUBLE TROUBLE!"

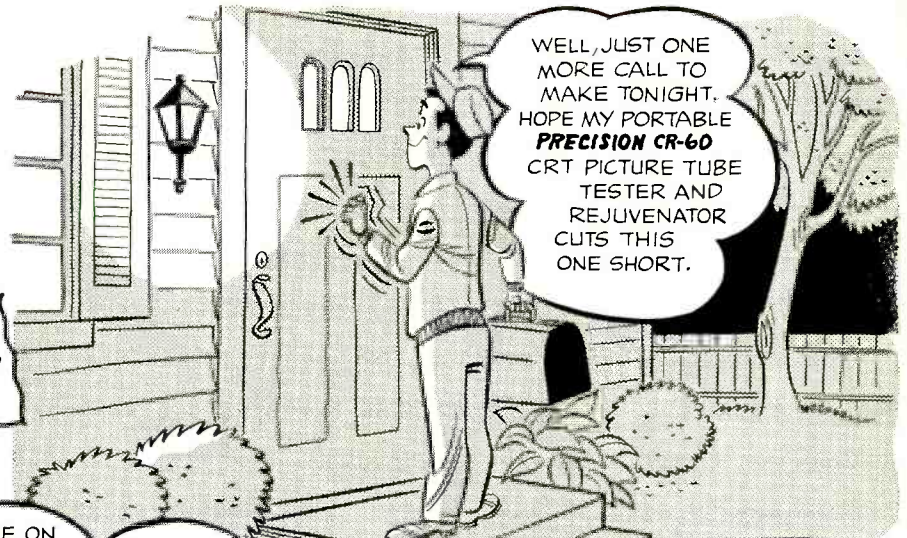

'EVENING, MISS DORA. HELLO, MISS FLORA. WHAT SEEMS TO BE THE TROUBLE?

THE PICTURE ON MY PORTABLE IS SO DARK, I CAN'T TELL THE COWBOYS FROM THE INDIANS!

AND ON MY COLOR SET, THE PICTURE IS DIM, TOO.

MMM...THE METER ON THE CR-60 READS BAD. A BOOSTER MAY HELP. WITH THE CR-60, I CAN INCREASE AC HEATER VOLTAGE TO SIMULATE A BOOSTER.

I'M SORRY, THE METER STILL READS "BAD" AND EVEN TRYING TO REJUVENATE DOESN'T HELP. YOU'LL NEED A NEW PICTURE TUBE.

OH, DEAR! ARE YOU SURE?

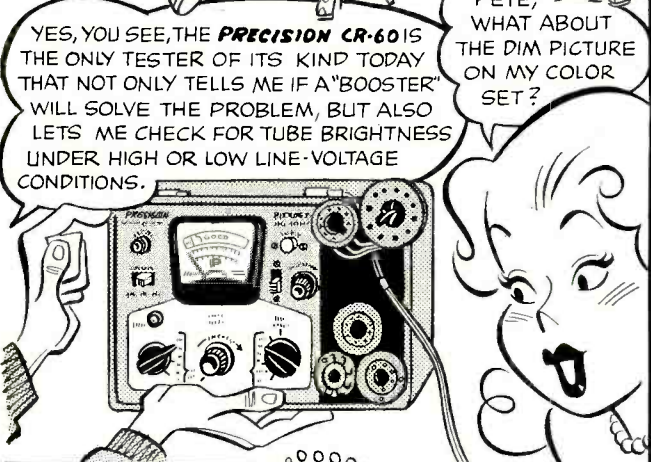
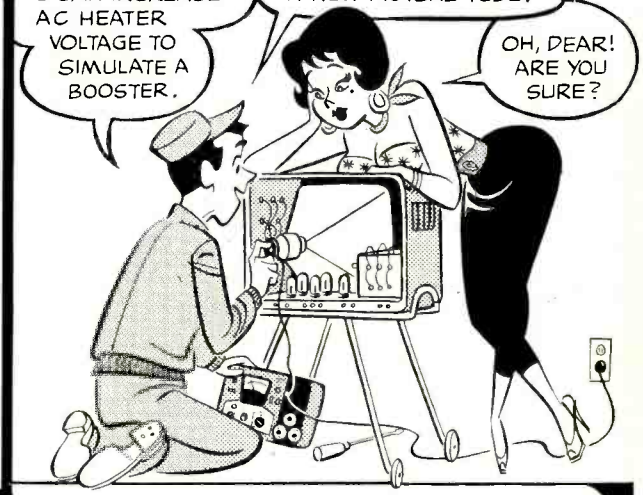

YES, YOU SEE, THE **PRECISION CR-60** IS THE ONLY TESTER OF ITS KIND TODAY THAT NOT ONLY TELLS ME IF A "BOOSTER" WILL SOLVE THE PROBLEM, BUT ALSO LETS ME CHECK FOR TUBE BRIGHTNESS UNDER HIGH OR LOW LINE-VOLTAGE CONDITIONS.

PETE, WHAT ABOUT THE DIM PICTURE ON MY COLOR SET?

WELL, THE PICTURE TUBE IS FINE, SO THIS DIMNESS MUST BE DUE TO SOME OTHER CONDITION. PROBABLY IN THE CHASSIS. WHEN I COME BACK TOMORROW WITH YOUR NEW TUBE, DORA, I'LL BRING MY **PRECISION** COLOR TEST EQUIPMENT TO FIND THE TROUBLE.

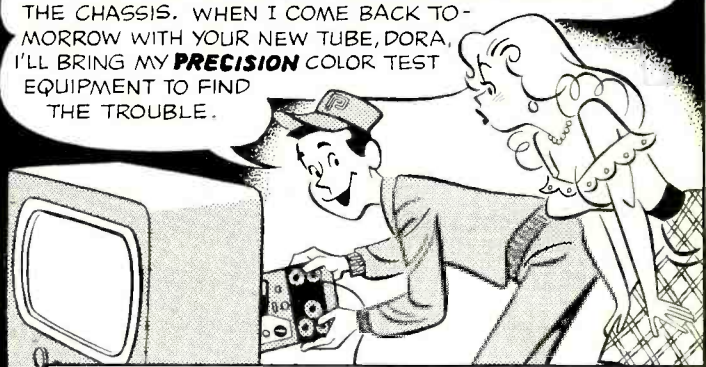

OH, PETE! YOU'RE WONDERFUL! WE'LL SEE YOU TOMORROW.

THAT'S ONE CALL-BACK I'M GOING TO ENJOY, THANKS TO **PRECISION'S CR-60** CRT TESTER AND REJUVENATOR.

SERVICEMEN: QUICKER SERVICE WITH THE **CR-60** ELIMINATES MANY CALL-BACKS, SAVES TIME AND EARNS YOU MORE PROFIT. FOR MORE SERVICE TIPS WITH THE **CR-60** (DEALER NET \$64.95), WRITE FOR BULLETIN #100. **IT'S FREE!**

PRECISION APPARATUS CO., INC.

70-31 84th STREET - GLENDALE 27, N.Y.

ALL PRECISION TEST EQUIPMENT IS GUARANTEED FOR ONE FULL YEAR AND BACKED BY OVER 30 YEARS OF ELECTRONIC EXPERIENCE.



New Heavy Duty RFI Suppression Kit For Mobile Radio



The Sprague Type SK-1 SUPPRESSIKIT— Easily installed on any truck, car, or boat engine using a 2-pole d-c generator.

RADIO HAMs, fleet owners, and CB operators can now enjoy clearer, more readable, less tiring mobile communications at longer effective ranges.

Sprague's new Type SK-1 SUPPRESSIKIT provides effective RF Interference suppression—at moderate cost—up through 400 megacycles. Designed for installation on automobiles, trucks or boats with either 6-volt or 12-volt generators, the Suppressikit makes possible high frequency interference control by means of Sprague's new, extended range, Thru-pass® capacitors.

The components in the SK-1 Suppressikit are neatly marked and packaged, complete with easy-to-follow installation instructions. All capacitors are especially designed for quick, simple installation. Unlike general-purpose capacitors, these heavy-duty units are rated at 60 amperes, and will operate at temperatures to 125°C (257°F). This means you'll have no trouble with an SK-1 installation in the terrific temperatures found "under the hood" on a hot summer's day. There's no chance of generator failures from capacitor "short outs", as with 85°C general purpose capacitors.

The Deluxe Suppressikit is furnished complete with an 8-foot shielded lead on the generator capacitor which can be trimmed to necessary length for any car or small truck, preventing RF radiation from armature and field leads.

Containing only 5 easy-to-install capacitors, the Deluxe Suppressikit is truly a "do-it-yourself" kit. The net price of \$17.85 is a little higher than that of makeshift, thrown-together kits, but it saves you so much time and aggravation it's well worth the slight extra cost.

If the SK-1 Suppressikit is not available at your Sprague Electronic Parts Distributor, send your order to Sprague Products Company, 81 Marshall St., North Adams, Mass.

Sprague TWIST-LOK® Capacitors give you 2 tremendous advantages over all other twist-prong electrolytics



1

**The right size,
the right rating, for
EVERY replacement job**

No need to compromise or improvise...the TWIST-LOK Line includes over 1690 different capacitors . . . It's the industry's most complete selection of twist-prong type capacitors, bar none!

2

**Exclusive, improved
cover design for
greater dependability**

Type TVL Twist-Lok Capacitors are now more dependable than ever! Sprague's new cover design provides a truly leak-proof seal and permits capacitors to withstand higher ripple currents.

Compare internal construction of TWIST-LOK to ordinary 'lytic!

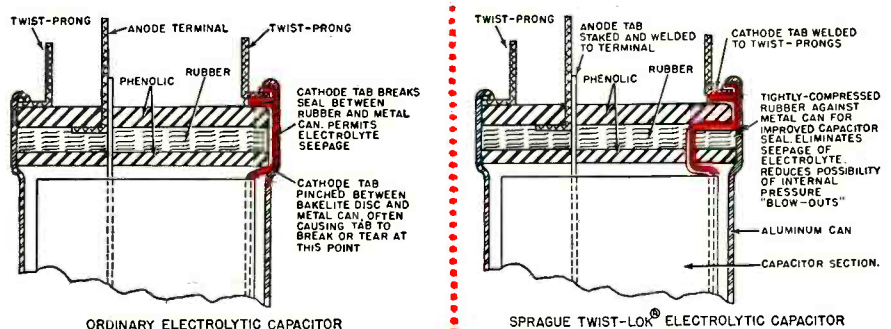

Complete listings are shown in handy Wall Catalog C-457. Get your copy from any Sprague Distributor, or write to Sprague Products Company, 81 Marshall St., North Adams, Mass.

**WORLD'S LARGEST
MANUFACTURER OF CAPACITORS**



Check these outstanding SONY features:

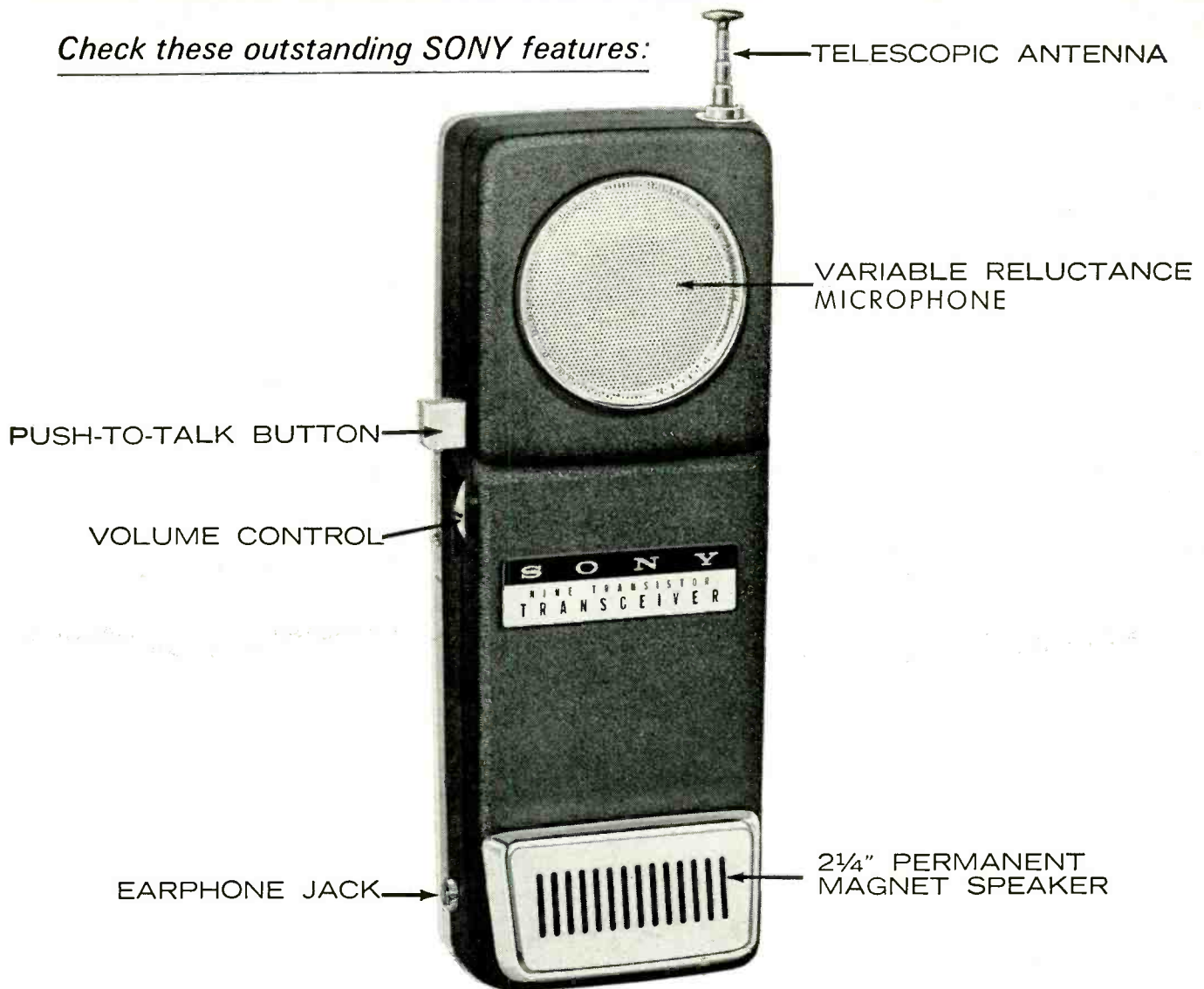

TELESCOPIC ANTENNA

VARIABLE RELUCTANCE MICROPHONE

PUSH-TO-TALK BUTTON

VOLUME CONTROL

EARPHONE JACK

2 1/4" PERMANENT MAGNET SPEAKER

SONY® *quality Citizens Band Transceiver*

RESEARCH MAKES THE DIFFERENCE

The New Sony 9 Transistor Citizens Band Class D transceiver uses a SEPARATE MICROPHONE AND SPEAKER. A quality product of the world's foremost research and development team in transistor electronics, weighs only one pound and is powered by 8 penlite cells for up to 50 hours of operation. The crystal controlled CB-901 employs a sensitive variable reluctance microphone and 2 1/4" PM speaker. Note how the microphone and speaker are each placed in the most natural position for transmitting and receiving. With 5 foot telescoping whip, push-to-talk button and volume control, the SONY CB-901 lists at **\$149.95** per pair, including batteries, earphones and leather case. Stop in at your dealer's and test it today.

Also see the amazing **SONY 8-301W TV**, the only truly portable, fully transistorized set that works on its own battery pack, 12v auto/boat battery and AC. Weighs a mere 13 1/4 lbs. List **\$249.95**. BCP-2 alkaline battery power pack, **\$39.95**.

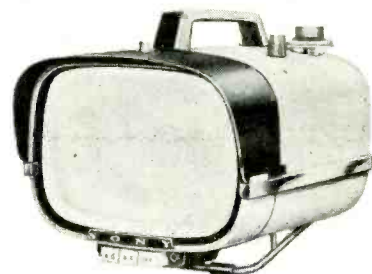

SONY CORP. OF AMERICA

514 Broadway, New York 12, N. Y.
Regional Offices
Western: 627 South Towne Ave., Los Angeles 21, Calif.
Central: 4959 W. Belmont Ave., Chicago 41, Ill.

Please send me the Sony "FACTS" booklet covering the SONY 8-301W TV and information on the SONY CB-901 Transceiver.

NAME _____

ADDRESS _____

CITY _____ ZONE _____ STATE _____

SONY CORP. OF AMERICA, 514 B'WAY, N.Y. 12, N.Y.

(Continued from page 16)

Parametric Amplifier Features New Noise Figure

A microwave amplifier with a noise figure of about 0.9 db, the lowest noise ever achieved by this type of amplifier, is reported by Bell Telephone Laboratories. A new, hermetically sealed gallium arsenide diode is one of the factors contributing to the improvement in this amplifier. Another contributor is a new

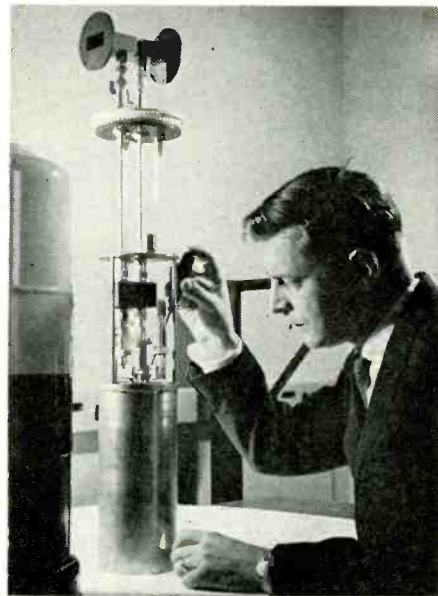

K. M. Eisele of Bell Labs makes final adjustment to new low-noise parametric amplifier before it is sealed into its cavity and immersed in liquid nitrogen.

cooling arrangement, in which the amplifier is contained in a metal cavity, sealed by indium wire and immersed in liquid nitrogen. This leads to more even cooling, and improves operating stability. The nitrogen cannot leak into the device.

Brief Briefs

A tandem Van de Graaff 15,000,000-electron-volt accelerator is being installed by Rutgers University, New Jersey, in collaboration with the Bell Telephone Laboratories. It will be used in nuclear research by both organizations.

A semiconductor strain gage with an output powerful enough to drive panel meters direct has been introduced by International Resistance Co. The new strain-gage pressure transducer is rated for 5 volts dc output, and will not require amplifiers in most applications.

A video tape recorder weighing only 30 pounds, and able to record ½ hour of television pictures, was announced by the Goddard Space Flight Center. The little recorder, developed by Ampex, occupies less than 1 cubic foot of space, and will be used in satellites.

Paul B. Findley, editor of the Bell Laboratories Record for 27 years, until his retirement in 1952, died at the age of 73. **END**

RADIO-ELECTRONICS

WE GET BETTER TV RECEPTION THAN YOU DO



YOU DO NOT



YES WE DO



NO YOU DON'T



WE HAVE A WINEGARD ELECTRONIC POWERTRON ANTENNA



OH!



DON'T SEE HOW ANYONE GETS ALONG WITHOUT A POWERTRON



Winegard

ANTENNA SYSTEMS

Winegard Co.,
3013-5 Scotten,
Burlington, Iowa

See Only the Scale You Want...in the Exact Range You Want

just set the range switch
and the correct scale appears
AUTOMATICALLY

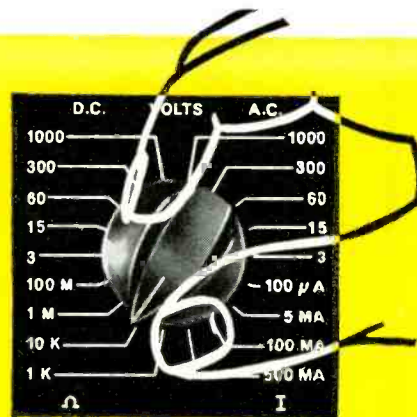

in the new **B&K**
VOM and VTVM

V O M A T I C 360

AUTOMATIC VOLT-OHM MILLIAMMETER

WITH
BURN-OUT PROOF
METER

Greatly simplifies your VOM use. Individual full-size scale for each range—and only one scale visible at any one time, automatically. Once you set the range switch, it is impossible to read the wrong scale. Reading in the range you want is amazingly easy—and direct. No reading difficulties, no multiplying, no errors.

Sensitivity 20,000 ohms per volt DC; 5000 ohms per volt AC. **Accuracy** $\pm 3\%$ DC; $\pm 5\%$ AC; (full scale). **DC Volts** in 6 ranges 0-6000. **AC Volts** in 6 ranges 0-6000. **AF (Output)** in 4 ranges 0-300 volts. **DC Current** in 5 ranges 0-10 amps. **Resistance** in 4 ranges 0-100 megohms. Supplemental ranges also provided on external overlay meter scales. Meter protected against extreme overload and burn-out. Polarity reversing switch. Automatic ohms-adjust control. Mirrored scale. Complete with 1½-volt and 9-volt batteries, test leads, and easy-viewing stand.

Net, \$5995



DYNAMATIC 375

AUTOMATIC VACUUM-TUBE VOLTMETER

Once you set the range switch, you automatically see only the scale you want and read the exact answer directly. Saves time, eliminates calculation, avoids errors. Individual full-size direct-reading scale for each range. Simplifies true reading of peak-to-peak voltages of complex wave forms in video, sync and deflection circuits, pulse circuits, radar systems, etc. Includes DC current ranges, too.

Accuracy $\pm 3\%$ full scale AC and DC. **Sensitive** 100 microampere meter movement. **DC Volts** in 7 ranges 0-1500. **AC Volts (rms)** in 7 ranges 0-1500. **AC Volts (peak-to-peak)** in 7 ranges 0-1500. **DC Current** in 3 ranges 0-500 ma. **Ohms** in 7 ranges 0-1000 megohms. Utilizes single DA-AC ohms probe and anti-parallax mirror. Swivel stand converts to carry-handle. Includes 1½ volt battery. Operates on 117 volts 50-60 cycle AC.

Net, \$8995

Ask Your B&K Distributor
for Demonstration, or
Write for Catalog AP18-E



B & K MANUFACTURING CO.
1801 W. BELLE PLAINE AVE • CHICAGO 13, ILL.
Canada: Atlas Radio Corp., 50 Wingold, Toronto 19, Ont.
Export: Empire Exporters, 277 Broadway, New York 7, U.S.A.

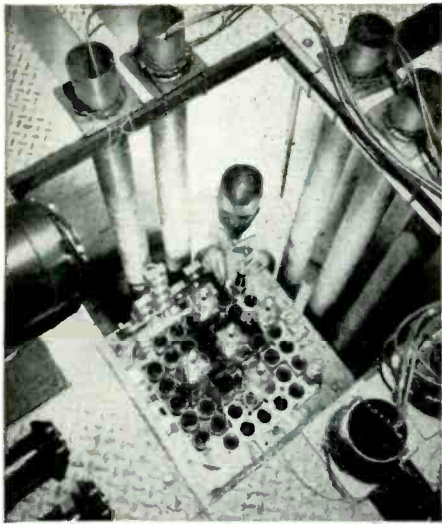

GET FACTS NOW...

CREI can prepare you for Career Opportunities in Nuclear POWER

WELL PAYING, EXCITING POSITIONS are created every day in the rapidly expanding nuclear field. Yet many are unfilled because industry cannot find qualified men.

YOU CAN PREPARE YOURSELF to take advantage of these opportunities. And build a rewarding career in this industry of the future through the CREI Home Study Program in Nuclear Engineering Technology. You can do it while on your present job.

CREI HAS A WORLD-WIDE REPUTATION earned in 35 years experience in advanced technical education. Thus, scientists in government and in private industry cooperated in preparing this vitally needed program.

YOU CAN QUALIFY for this program if you have a technical background and a high school education or the equivalent. For detailed information on career opportunities and CREI Programs, use coupon below.

MAIL COUPON TODAY FOR FREE 58 PAGE BOOK

CREI



A Division of
The Capitol Radio Engineering Institute
Dept. X1405-K, 3224 Sixteenth St., N.W.
Washington 10, D. C.

Please send me details of CREI Home Study Programs and Free Book, "Your Future in Electronics and Nuclear Engineering Technology."

Name _____ Age _____

Address _____

City _____ Zone _____ State _____

Education: Years High School _____

Other _____

30

Correspondence



LIKES TROUBLESHOOTING CHARTS

Dear Editor:

Your radio troubleshooting charts that appeared last November and December are just the thing for lazy guys like me. They sure are tops. When are you going to come out with a TV trouble chart?

R. J. CORRIGAN

Dayton, Ohio

[Whether or not he is lazy, the charts help a technician form good servicing habits—to develop a radio servicing technique that will save him time, effort and headaches. The TV trouble chart is a lot more complex. When we have one that really works you'll be sure to see it in RADIO-ELECTRONICS.—Editor]

INSTANT ON

Dear Editor:

After seeing the item on "Instant On" in the January 1962 issue, I decided to add such a circuit to a small radio for testing. After studying the diagram, I could not devise a way to replace the special switch-volume control now in the set. Instead, I installed a silicon rectifier across the switch and left the B-plus on. As I see it, with the two rectifiers back to back, it is almost an open circuit anyway. Maybe my theory is wrong on this, but it seems to be working fine.

DICK ROGERS

Rogers Electronics
Brighton, Mass.

[The author thought of that, too! He tried the same thing and it popped the silicons—repeatedly. Experiments are continuing—more will appear in a future issue.—Editor]

NO SUSPICION?

Dear Editor:

Looking through your October issue I rather belatedly came across this gem of modesty by Mr. Crowhurst: "... we suspect that we now know more ... than anyone else in the industry." This is no mere suspicion with Mr. Crowhurst. It's been a conviction of his for years.

In fairness to your other advertisers, don't you think it's time you started charging Mr. Crowhurst your established rates, and taking his copy out of the editorial section?

Mr. Crowhurst is less interested in advancing the art of stereo—or in anything else—than gratifying his monumental vanity, indisputably the greatest in the industry. He has a

TESTS PROVE POLYCAP[®] CASE & SPECIAL END SEAL ON AEROVOX BI-ELECTRIC MYLAR PAPER BYPASS CAPACITORS ELIMINATE CRACKING & CHIPPING PROBLEMS

PRODUCT NEWS FROM

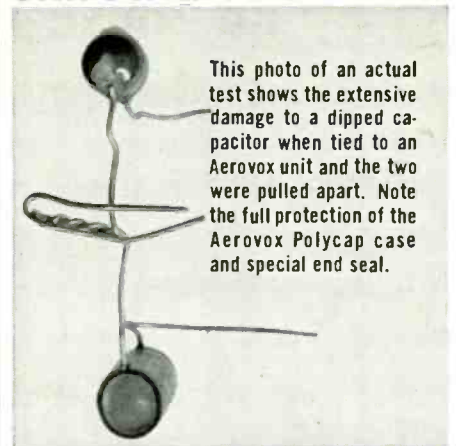

This photo of an actual test shows the extensive damage to a dipped capacitor when tied to an AeroVox unit and the two were pulled apart. Note the full protection of the AeroVox Polycap case and special end seal.

Why take chances with the cracking and chipping problems common with conventional dipped capacitors. After all, your profits and your reputation are at stake with every set you service—protect both by replacing with only genuine AeroVox Bi-Electric Mylar[®] Paper Bypass Capacitors! You see, actual tests prove that the uniform, protective Polycap case from end-to-end, and the special process-controlled end seals, eliminate your cracking and chipping troubles. No wasted time ... no expensive call-backs, as service technicians everywhere know from experience.

*Registered DuPont trademark

Look for this famous Bi-Electric stand at your distributor's store ... headquarters for the complete line of top-quality AeroVox capacitors, resistors and kits.

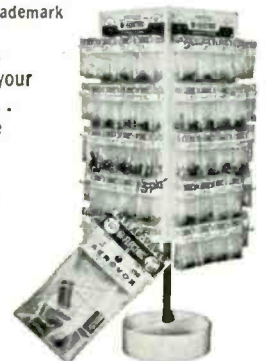

AEROVOX CORPORATION
DISTRIBUTOR DIVISION NEW BEDFORD, MASS.
Technical Leadership - Manufacturing Excellence

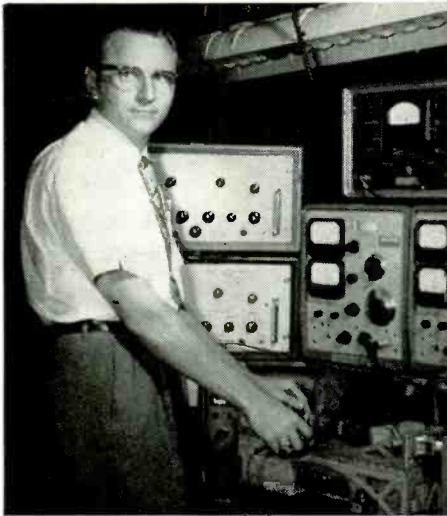

RICHARD S. CONWAY (CREI grad 1960) is Supervisor, Electronic Test Department Wilcox Electric Co., Kansas City, Mo.

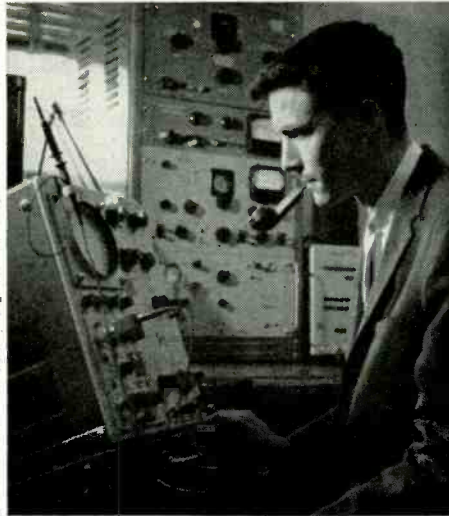

ROBERT T. BLANKS (CREI grad 1960) is Engineer, Research & Study Div., Vitro Labs., Division of Vitro Corp. of America, Silver Spring, Md.

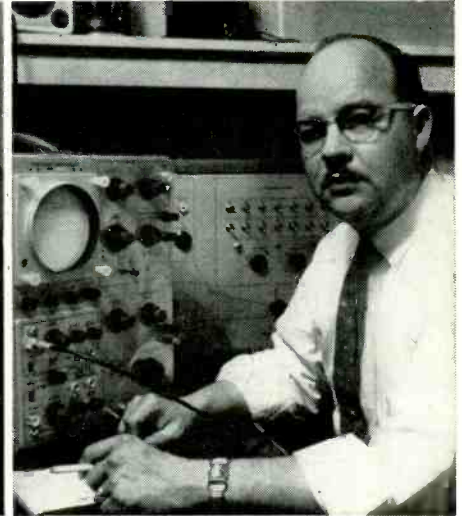

MEARL MARTIN, Jr. (CREI grad 1956) is a Senior Engineer and Field Support Manager, Tektronix, Inc., Portland, Oregon.

Why do these men now enjoy profitable careers in electronics that others still dream about?

SUCCESS IS NO ACCIDENT. There is a reason why some men move ahead in electronics while others stand still, year after year, in routine, low-paid jobs. Responsible, rewarding positions in electronics require advanced technical knowledge. Without such knowledge, you cannot hope for success no matter how bright and ambitious you are.

THE THREE MEN SHOWN ABOVE realized that career opportunities would open up for them only if they gained the practical knowledge of electronic engineering technology demanded by industry. They gained this knowledge through CREI Home Study Programs and achieved the success they desired.

YOU HAVE THE SAME OPPORTUNITY. Through CREI Home Study Programs, you can acquire the practical working knowledge of advanced and up to date electronic engineering technology that will put you on the level of specialization where men are most in demand.

YOU WILL FOLLOW THE FOOTSTEPS of the thousands of CREI men who hold positions as associate engineers, engineering aides, field engineers, project engineers and technical representatives. They work in every area of electronics, from manufacturing to the space program.

WHEN YOU ENROLL IN A CREI HOME STUDY PROGRAM, you study courses to which a number of leading engineers and scientists have made substantial contributions. You are guided and assisted by CREI's staff of experienced instructors.

YOU HAVE A CHOICE OF PROGRAMS covering every field of electronics:

RADAR • COMPUTERS • SERVOMECHANISMS • INSTRUMENTATION • AERONAUTICAL AND NAVIGATIONAL • COMMUNICATION • TELEVISION • AUTOMATION AND INDUSTRIAL ENGINEERING TECHNOLOGY • NUCLEAR ENGINEERING TECHNOLOGY

CREI EDUCATION IS RECOGNIZED by many large corporations such as National Broadcasting Company, Pan American Airways, Federal Electric Corporation, The Martin Company, Canadian Broadcasting Co., Mackay Radio, and many others. These companies often pay all or part of CREI tuition for their employees.

CREI HAS 35 YEARS OF EXPERIENCE in advanced technical education through home study. CREI has de-

veloped electronics courses for the Army Signal Corps, special radio technician courses for the Navy, and group training programs for leading aviation and electronics companies. CREI also maintains a Residence School in Washington, D. C.

YOU CAN QUALIFY for a CREI Program, if you have basic knowledge of radio or electronics and are a high school graduate or the equivalent. If you meet these qualifications, write for **FREE 58-page book** describing CREI Programs and career opportunities in advanced electronic engineering technology. Mail coupon or write to: The Capitol Radio Engineering Institute, Dept. 1405-K, 3224 Sixteenth St., N.W., Washington 10, D. C.

Mail coupon today for **FREE 58-page book**



THE CAPITOL RADIO ENGINEERING INSTITUTE

Founded 1927

Dept. 1405-K, 3224 Sixteenth St., N.W., Washington 10, D.C.

Please send me details of CREI Home Study Programs and Free Book, "Your Future in Electronics and Nuclear Engineering Technology." My qualifications are noted to obtain immediate service.

CHECK FIELD OF GREATEST INTEREST:

- Electronic Engineering Technology Nuclear Engineering Technology
 Servo and Computer Engineering Technology Automation and Industrial Electronic Engineering Technology
 Aero and Navigational Engineering Technology

Name _____ Age _____

Address _____

City _____ Zone _____ State _____

Employed by _____

Type of present work _____

Education: Years High School _____ Other _____

Electronics Experience _____

Check: Home Study Residence School G.I. Bill

28



What's the difference in loudspeakers that makes Quam so special?

All loudspeakers look pretty much alike, and may even sound pretty much alike—yet Quam speakers are different—in a way that's very important to you who use them!

the
difference
lies
in
**PERFORMANCE
RELIABILITY**

When it's a Quam speaker—you install it and forget it. Quam speakers are built to give long, trouble-free performance.

Quam's factory is a manufacturing plant, not merely an assembly shop. By making our own speaker parts, we can guarantee the quality of the materials that go into them. Our voice coils are centered precisely; each and every speaker is thoroughly tested; the product you get meets the standards we have insisted on for almost forty years.

Quam Quality Line speakers are enameled in gold—and while the color has no effect on performance characteristics, it symbolizes the quality and reliability that's built into every Quam speaker.

ASK FOR

QUAM

**THE QUALITY LINE—
for all your speaker needs**

QUAM-
NICHOLS
COMPANY

238 East Marquette Road
Chicago 37, Illinois

NOW! LEARN HOW TO SERVICE TRANSISTOR RADIOS

THE QUICKEST, EASIEST WAY SO YOU CAN EARN BIG PROFITS!

you'll get money-making know-how from the COMPLETE 16-LESSON
"PRACTICAL TRANSISTOR RADIO SERVICING COURSE"

available as an exclusive BONUS FEATURE for
PHOTOFACT® SUBSCRIBERS!

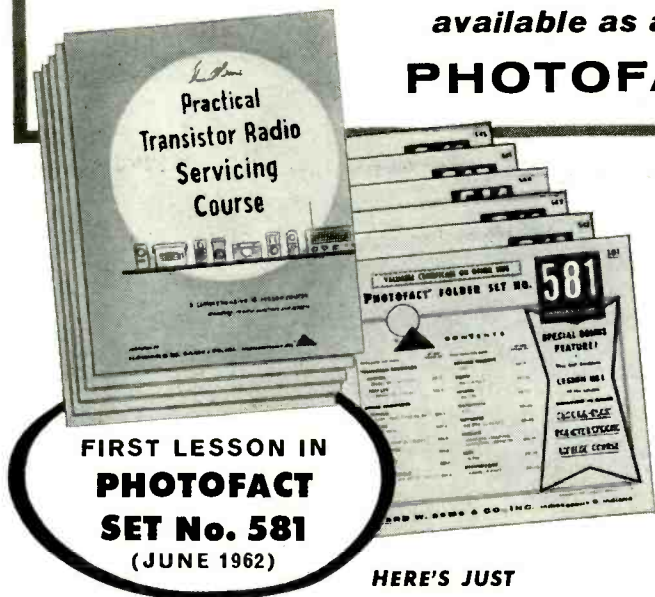

**FIRST LESSON IN
 PHOTOFACT
 SET No. 581
 (JUNE 1962)**

**HERE'S JUST
 WHAT YOU NEED**

TO CASH IN ON THIS HUGE SERVICING MARKET!

Servicing small transistor radios can be a real headache and a financial loss to service technicians—UNLESS you have the knack of quickly locating and repairing troubles caused by faulty miniature components or defective printed boards.

The Howard W. Sams PRACTICAL TRANSISTOR RADIO SERVICING COURSE gives you the special knowledge and techniques you need to become an expert on transistor radios—so you can repair all types at a profit.

You get practical know-how, based on years of on-the-job experience. You get down-to-earth text on every phase of transistor radio servicing (see Lesson list at right), PLUS large pictorial photos showing you why, what and how.

The transistor radio servicing market is huge and growing, with millions of customers crying for service. There's big money to be made by those who know the shortcuts to quick, effective repair. The Sams PRACTICAL TRANSISTOR RADIO SERVICING COURSE can make you an expert, can give you the speedy know-how you need to earn big money consistently.

SUBSCRIBE TODAY—Get This Timely BONUS Course!

Here's the Course you get with your Photofact Subscription!

- Lesson 1. Transistor Radio Components.** Description of transistors, diodes and thermistors in transistor radio circuits, and other components used in miniature portables.
- Lesson 2. Transistors in Operation.** Biasing, loads, temperature effects, polarities, positive and negative grounds, heat dissipation.
- Lesson 3. Measurements in Transistor Circuits.** Voltage resistance, and current measurements in audio, RF and IF amplifiers, oscillators, detectors and other circuits.
- Lesson 4. Transistor Circuit Checks.** Reading schematics, using CircuTrace®, measuring voltages and resistances.
- Lesson 5. Transistor Radio Construction.** Cabinets and case construction, chassis removal, care of plastics and use of solvents.
- Lesson 6. Special Tools.** Soldering devices, miniature tools used in assembly, disassembly, and repair of transistor radios.
- Lesson 7. Troubleshooting Techniques.** Preliminary tests, current and voltage checks, and signal-tracing techniques used in isolating troubles.
- Lesson 8. Making Effective Use of Test Equipment.** Test equipment needs and applications.
- Lesson 9. Servicing Procedures.** Where to start; step-by-step checks.
- Lesson 10. Analyzing Troubles by Symptoms.** Commonly-found problems, recognizing the symptoms, and locating defective components.
- Lesson 11. Alignment and Adjustment.** Step-by-step procedures plus time-saving hints.
- Lesson 12. Improving Performance.** Techniques for improving the operation of noisy and/or weak receivers.
- Lesson 13. Repairing Printed-Boards.** How to isolate printed-wiring defects and replace faulty components.
- Lesson 14. Transistor Replacement.** Selecting and installing suitable types.
- Lesson 15. Auto Radios.** Special requirements for servicing hybrid and all-transistor models.
- Lesson 16. Replacement Parts.** How to repair defective components; sources for replacements.

PLUS — to-the-point Questions & Answers to help you check your progress!

DON'T MISS A SINGLE ISSUE!

Subscribe today through your Sams Distributor to receive all PHOTOFACT Sets as issued each month. Beginning in June, 1962, you will start receiving the 16-lesson Practical Transistor Radio

Servicing Course as a bonus with your subscription to PHOTOFACT—the world's finest tv-radio servicing data!

SUBSCRIBE TODAY!

Are You Enjoying the Benefits of Membership in "PEET"?

Join the thousands who have qualified and profited by membership in the "PEET" Program. If you now own a PHOTOFACT Library or plan to own one, you can apply for membership. It's the *only* program designed to build powerful public acceptance for you, which means increased business and profits. You get dozens of free promotional aids. Benefits cost you absolutely nothing if you qualify. Ask your Sams Distributor for the "PEET" details or mail coupon today.



Powerful national advertising monthly in TV Guide now carries the "PEET" message to over 8,000,000 TV families, building dynamic support and demand for the services of "PEET" members. Now more than ever it pays to qualify as a "PEET" member!

Howard W. Sams & Co., Inc., Dept. 6-E2
 1724 E. 38th St., Indianapolis 6, Ind.

I would like to enter my subscription to Photofact, effective with Set No. 581

My Distributor is: _____

Send me details on how to become a "PEET" Member

Shop Name _____

Attn. _____

Address _____

City _____ Zone _____ State _____

**LEADERSHIP
IS NEVER AN
ACCIDENT...**

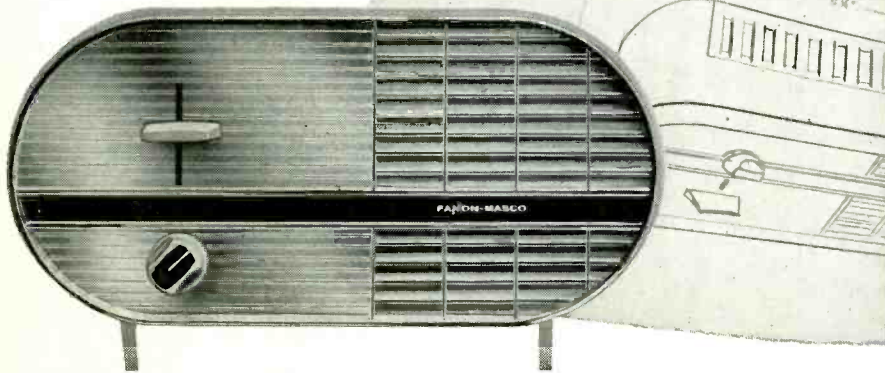

It's always planned. FANON-MASCO has been the acknowledged leader in the manufacture of quality intercoms for years. Not content to rest on its laurels as the number one seller FANON-MASCO keeps striving continually to make its better products even better.

That's why FANON-MASCO turned its entire line over for redesign to one of America's leading industrial designers. Results? A triumph of distinctive styling never before approached. From its clean, sculptured lines to the rich harmonies of high styling decor in beige and gold, FANON-MASCO's new intercoms are stamped with the "look of tomorrow".

Of course, none of these improvements have been made at any sacrifice of FANON-MASCO's outstanding qualities. You still get better performance, greater reliability, and value pricing thanks to FANON-MASCO's unmatched experience, versatility, and dependability.

Yes. Leadership is no accident. We planned it that way. Write for complete information. FANON-MASCO, 439 Frelinghuysen Avenue, Newark 14, N. J., Dept. 101.



A complete line of P.A. amplifiers loaded with big extra features you'd pay much more for in any other line. Mobile and AC models available from 8 to 70 watts output. From \$57.50 List

MODEL FCB-9 Transistor Citizens Band Communicator. 2-Way radio for business, camps, boating and all sports. 2 to 6 mile range depending on terrain. Complete with ear-phone, carrying case, battery: List \$64.95 each



FANON-MASCO

439 Frelinghuysen Ave., Newark 14, N.J. ■ Export: Roburn, 431 Greenwich St., N.Y.

mortal fear that his genius will not be fully appreciated, a tragedy he intends to avoid if he has to hit his readers on the head.

ROBERT G. VAUGHAN
Greensboro, N. C.

QUESTION OF RELIABILITY

Dear Editor:

In your February 1962 issue there was a very interesting letter in your correspondence column from Mr. W. F. Palmer, of Palmer Electronics Labs.

In it, he suggested that the reliability of the thyatron ignition system (September 1961) was questionable, and initial and maintenance costs were high. As a manufacturer of transistorized ignition I am inclined to believe this.

Our Magnition works on a similar basis to Mr. Palmer's Transfire but is different in many ways. The Magnition has two power transistors in the switching circuit, and two transistors in a multivibrator circuit controlled by the points.

As in Mr. Palmer's circuit, a special coil is used in our unit, as well as Zener diodes for transient voltage protection.

There have been many letters of controversy in the matter of transistor vs. conventional and other types of ignition but, should I be in a position to choose, I would take transistor ignition over all.

KARL M. WIESSMANN
Design Engineer
Hofmann Electronics Co.
Wayne, N.J.

ELECTRONIC PATHFINDER

Dear Editor:

In the September 1961 issue of RADIO-ELECTRONICS appeared an article on an electronic pathfinder. Don't you think this is going to a lot of trouble

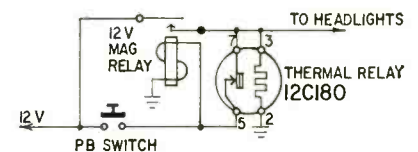

when something as easy as this could be built?

The pushbutton switch energizes the 12-volt relay, thermal delay relay and headlights. After 180 seconds have elapsed, the normally closed contacts of the thermal relay open, de-energizing the entire system.

WILLIAM CHAKERES
Newark, N. J.

DDT FOR GREMLINS

I note the sound and fury still running on the electronic ignition system. I finally put one together and my troubles began. But I found that, when I finally boiled it for one hour in 100% DDT, the gremlins disappeared and it was ready for the field test. I'll report when the field test is completed.

In the meantime I've been experi-



To assure **ADVANCEMENT** or to turn your hobby into a new and **PROFITABLE CAREER** in the fast growing field of **ELECTRONICS**

you should investigate the **NRI Home-Study Courses in Industrial Electronics, Radio-TV Servicing, Radio-TV Communications**

Qualify for Higher Pay

You must be *trained* to qualify for higher earnings and advancement. Whichever branch of Electronics you select, you'll find that NRI training is the time-proved way to get into this interesting and fast growing industry.



Training Equipment Included

When you learn Electronics through NRI you use scientifically developed "learn-by-practice" methods. At no extra cost, NRI sends special equipment that gives actual experience, makes theory you learn come to life in an easy-to-grasp, interesting manner. You perform a wide variety of experiments working with basic circuits and components. All equipment is yours to keep.



Oldest and Largest School

For nearly half a century, NRI has featured Electronics training, progressing from Radio and Television servicing and communications to Industrial and Military Electronics. As the oldest and largest home-study school of its kind, NRI can supply training at reasonable cost. Monthly payment plans. Take the first step toward a successful career now. Mail postage-free card. Get NRI CATALOG without cost or obligation. **National Radio Institute, Washington 16, D.C.**

There is an immediate and growing need for trained Technicians in many branches of Electronics. In fact, four to seven trained Technicians are needed for every graduate engineer. Better than average jobs await you in the fast growing industry of the 1960's . . . offering high pay and prestige, interesting work and a bright future. Join the thousands of NRI graduates who have benefited from career opportunities in this Electronic Age. Mail the postage-free card today.

Turn Page for Facts on NRI Courses ▶

Cut Out and Mail—No Stamp Needed



NATIONAL RADIO INSTITUTE
Washington 16, D. C. RE

Please send me your Electronic, Radio-TV catalog without cost or obligation. I am interested in course checked below. (No salesman will call. PLEASE PRINT.)

- | | |
|---|---|
| <input type="checkbox"/> Industrial Electronics | <input type="checkbox"/> FCC License |
| <input type="checkbox"/> Radio-TV Servicing | <input type="checkbox"/> Communications |

Name _____ Age _____

Address _____

City _____ Zone _____ State _____

ACCREDITED MEMBER NATIONAL HOME STUDY COUNCIL
Approved for Veteran's under Korean GI Bill

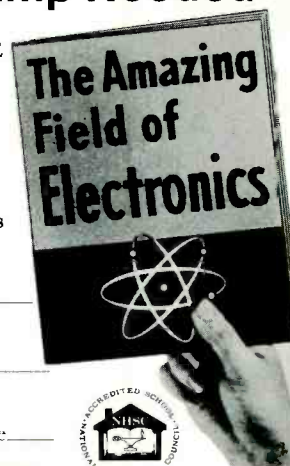

PICK THE CAREER YOU WANT IN THE WONDERFUL FIELD OF ELECTRONICS TRAIN AT HOME WITH THE LEADER

INDUSTRIAL ELECTRONICS



Prepare for a career as an Electronic Technician in industry, business, government, the military, with this NRI course in Electronics—Principles, Practices, Maintenance. Computers, telemetry, automation, missiles, rockets all employ the same basic principles . . . and that is what this NRI course stresses with illustrated lessons, special training equipment.

TELEVISION-RADIO SERVICING (INCLUDES COLOR TV)

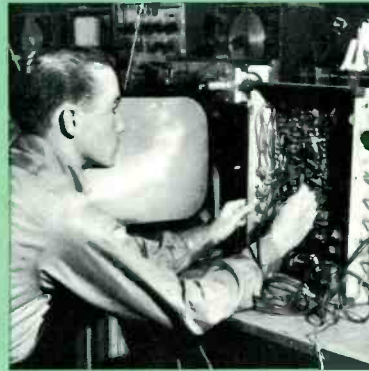

NRI's time-tested course in Servicing not only trains you to fix radios, TV sets, hi-fi, etc., but also shows you how to earn spare-time money starting soon after enrolling. Fast growth in number of sets, color-TV, stereo, means money-making opportunities in your own spare-time or full-time business or working for someone else. Special training equipment included.

TV-RADIO COMMUNICATIONS

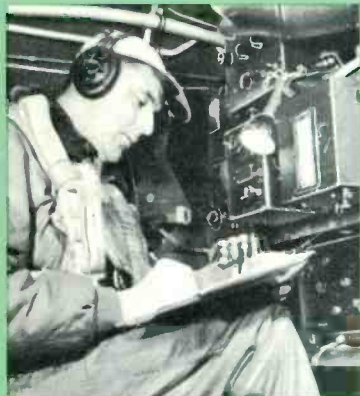

In the NRI Communications course you get *actual experience* as NRI prepares you for your choice of Communications fields and an FCC License. Commercial methods and techniques of Radio and TV Broadcasting; teletype; facsimile; microwave; radar; mobile and marine radio; navigation devices; FM stereo multiplexing are some of the subjects covered. You work with special training equipment.

FCC COMMERCIAL LICENSE



For men with Radio-TV experience who want to operate or service transmitting equipment used in broadcasting, aviation, marine, microwave, facsimile or mobile communications. A Service Technician is *required by law* to have an FCC License to work on C-Band, other transmitting equipment. From Simple Circuits to Broadcast Operation, this new NRI course trains you quickly for your Government FCC examinations.

SEE OTHER SIDE

Job Counselors Recommend

Today, a career in Electronics offers unlimited opportunity. Job counselors advise, "For an interesting career, get into Electronics." The National Association of Manufacturers says, "There is no more interesting and challenging occupation in American industry."

When you train for a career in Electronics through NRI home-study methods your home becomes your classroom, and you the only student. You pick your own study hours, study when you want, as long as you want. No need to give up your job or go away to school. And there are no special requirements of previous Electronics experience or education. Train with the leader. Your NRI training is backed by nearly 50 years of success. Mail the postage-free card. National Radio Institute, Washington 16, D.C.

FIRST CLASS
PERMIT
NO. 20-R
(Sec. 34.9, P.L.&R.)
Washington, D.C.

BUSINESS REPLY MAIL
NO POSTAGE STAMP NECESSARY IF MAILED IN THE UNITED STATES

POSTAGE WILL BE PAID BY

NRI  **National Radio Institute**
3939 Wisconsin Avenue
Washington 16, D.C.



MAIL POSTAGE-FREE CARD NOW

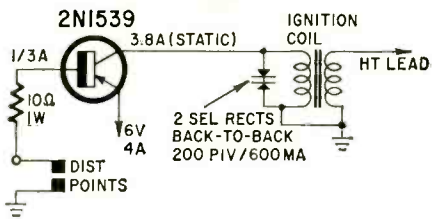

menting with a simple gadget for my Jeep. It gives me a spark many-fold hotter than the standard system, yet reduces current across the breaker points to a twelfth of its former value. Also the reverse surge is well damped. For interested parties the circuit is shown here.

WILLIAM K. GUTHRIE, JR.
Central City, Colo.

ELECTRONIC IGNITION AGAIN

Dear Editor:

After building the electronic ignition system described in the September 1961 issue, I had to make a change to get the unit to work in my 1960 V8 Lark. It was simply a matter of changing C5 from the indicated .001 μ f to .003 to trigger the 2D21 with the distributor points. I use the original 12-volt ignition coil on the car.

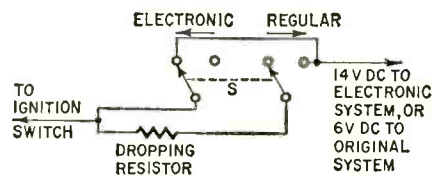

I found my lead from the ignition switch included a series-dropping resistor which gave me only 6 volts on starting. To overcome this, I installed a separate lead from the ignition switch and, by adding a dpdt switch, I retained the original wiring for use with the regular system if it should ever be needed. See the diagram for the hookup.

JOSEPH FREI
Alamogordo, N.M.

[Readers will find the value for C5 varies slightly according to the particular thyatron used and the car in which the system is installed.—Editor]

ABOUT THAT "X"

Dear Editor:

With all due respect, whoever wrote the caption "X = Trans" above Mr. Silverman's letter (September, 1961) is misleading Mr. Pearsall (January, 1962) and possibly many more of your readers. The use of "x" as a substitute for *part of a word* (not necessarily "trans") is as old as amateur radio telegraphy and perhaps as old as wire telegraphy. Typical examples include "px" (press), "wx" (weather) and "dx" (distance). See *The Radio Amateur's Handbook*, first edition, page 142.

Think hard. Back in December, how many times were you wished a "Merry Transmas"?

BYRON GOODMAN, W1DX
West Hartford, Conn. END

PRACTICAL INGENUITY IN ELECTRONICS



What is it? You might call it a philosophy... an idea... a principle.

What does it mean? Technical excellence, reliability, performance—combined with sensible pricing. On this philosophy rests the enviable Tarzian reputation for customer satisfaction. Too, it has earned for Sarkes Tarzian, Inc. recognition as the producer of "the world's finest tuner for the world's finest sets". You'll also find this same practical ingenuity in all of these electronic products from Tarzian:

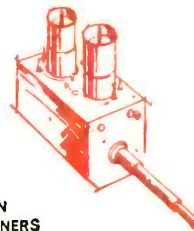

TELEVISION
and FM TUNERS

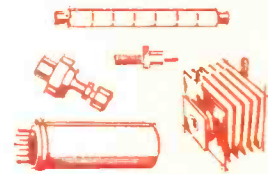

SEMICONDUCTOR DEVICES

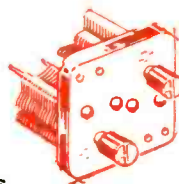

AIR
TRIMMERS

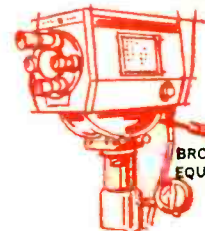

BROADCAST
EQUIPMENT



MAGNETIC TAPE



FM RADIOS and
AM/FM RADIOS

Electronic Products of Tomorrow... TODAY



SARKES TARZIAN INC

east hillside drive • bloomington, indiana • edison 2-7251



9 New Features Now In The New 1962 EICO RP100 Transistorized Stereo / Mono 4-Track Tape Deck

A great tape recorder made greater:

1. New professional studio recording hysteresis-synchronous capstan motor: 24 stator slots for ultra-smooth drive, ultra-quiet and vibrationless professional bearing system.
2. Two new take-up and rewind reel motors, both extra-powered for effortless operation.
3. New cored-out steel capstan flywheel with all the mass concentrated at the rim for improved flutter filtering.
4. New optimally designed capstan drive belt brings wow down to negligibility.
5. New relay provides instantaneous extra power to the take-up reel motor at start to minimize tape bounce. Provides near-perfect stop-and-go operation and eliminates any risk of tape spillage when starting with a nearly full take-up reel.
6. New automatic end-of-tape stop switch cuts off take-up reel motor power. Also permits professional editing techniques, whereby tape being edited out runs off the machine while you are listening to it.
7. Playback preamps remain "on" during stop-standby mode to permit cueing.
8. Recording level adjustment during stop-standby.
9. Shock-absorbent helical spring tape lifters practically eliminate tape bounce at start of fast winding.

And All These Well-known RP-100 Features:

Separate stereo 1/4 track record and playback heads permitting off-the-tape monitor and true sound-on-sound recording; separate transistor stereo record and stereo playback amplifiers meeting true high fidelity standards; monaural recording on 4 tracks; digital turns counter; electrodynamic braking (no mechanical brakes to wear out or loosen); all-electric push-button transport control (separate solenoids actuate pinch-roller and tape lifters); unequalled electronic control facilities such as mixing mic and line controls, two recording level meters, sound-on-sound recording selected on panel, playback mode selector, etc. Modular plug-in construction.

Wow and flutter: under 0.15% RMS at 7 1/2 IPS; under 0.2% RMS at 3 3/4 IPS. **Timing Accuracy:** ± 0.15% (±3 seconds in 30 minutes). **Frequency Response:** ± 2db 30-15,000 cps at 7 1/2 IPS, 55db signal-to-noise ratio; ± 2db 30-10,000 cps at 3 3/4 IPS, 50db signal-to-noise ratio. **Line Inputs Sensitivity:** 100mv. **Mike Inputs Sensitivity:** 0.5mv.

Semikit: Tape transport assembled and tested; electronics in kit form \$299.95
Factory-assembled: Handwired throughout by skilled American craftsmen \$399.95

An original, exclusive EICO product designed and manufactured in the U.S.A. (Patents Pending)

Carrying Case \$29.95
Rack Mount \$9.95



FM-AM Stereo Tuner ST96
 Kit \$89.95 Wired \$129.95
 Includes Metal Cover and FET



70-Watt Integrated Stereo Amplifier ST70
 Kit \$94.95 Wired \$129.95
 Includes Metal Cover

40-Watt Integrated Stereo Amplifier ST40
 Kit \$79.95 Wired \$129.95
 Includes Metal Cover



FM MULTIPLEX AUTODAPTOR MX99 (Patent Pending)
 Kit \$39.95 Wired \$64.95 Cover Optional \$2.95

An original EICO contribution to the art of FM-Multiplex reception

The MX-99 employs the EICO-originated method of zero phase-shift filterless detection of FM Stereo signals (patent pending) described in the January 1962 issue of AUDIO Magazine (reprints available). This method prevents loss of channel separation due to phase shift of the L-R sub-channel before detection and matrixing with the L+R channel signal. In addition, the oscillator synchronizing circuit is phase-locked at all amplitudes of incoming 19kc pilot carrier, as well as extremely sensitive for fringe-area reception. This circuit also operates a neon lamp-indicator, whenever pilot carrier is present, to indicate that a stereo program is in progress. The type of detection employed inherently prevents SCA background music interference or any significant amount of 38kc carrier from appearing in the output. However, very sharp L-C low pass filters are provided in the cathode-follower audio output circuit to reduce to practical extinction any 19kc pilot carrier, any slight amounts of 38kc sub-carrier or harmonics thereof, and any undesired detection products. This can prove very important when tape recording stereo broadcasts. The MX-99 is self-powered and is completely factory pre-aligned. A very high quality printed board is provided to assure laboratory performance from every kit. The MX-99 is designed for all EICO FM equipment (ST96, HFT90, HFT92) and component quality, wide-band FM equipment.

©1962 EICO Electronic Instrument Co. Inc.
 3300 Northern Boulevard, L. I. C., I. N. Y.

EICO, 3300-N. Blvd., L.I.C. 1, N.Y. C-5

- Send free 32-page catalog & dealer's name
- Send new 36-page Guidebook to HI-FI for which I enclose 25¢ for postage & handling.

Name _____

Address _____

City _____ Zone _____ State _____

Over 2 MILLION EICO Instruments in use.
 Most EICO Dealers offer budget terms.
 Add 5% in West.

Listen to the EICO Hour, WABC-FM, N. Y. 95.5 MC, Mon.-Fri., 7:15-8 P.M. Export Dept., Roburn Agencies Inc., 431 Greenwich St., New York 13

CLOSED-CIRCUIT TV ADVANCES

... Vast New Uses for Television Are in The Making ...

MASS closed-circuit TV, neglected for nearly two decades, suddenly has come of age in 1962. Closed-circuit TV is by no means a novelty; it has been with us since the very beginning of the television art. Baby-watching via TV; police lineups to precinct stations; surveillance of inmates in prisons, or of factory workers; machine inspection; factory gate-watching by night watchmen; TV cameras in hotel and apartment house lobbies that watch the inside of self-service elevators; round-table meetings with officials in different cities; bank surveillance of tellers to verify check signatures and to alert police during holdups; TV in large railroad terminals to speed ticket service; giant TV screens installed in various theaters throughout the country, all interconnected to exhibit sporting events, etc. and other uses too numerous to mention now operate in many parts of the world.

None of these examples, however, are true *mass* closed-circuit TV applications, for *individual* use in the viewers' homes or rooms. The nearest approach today are the Community Antenna Television (CATV) Systems throughout the United States and the Virgin Islands, according to a recent report by the National Community Television Association. There are now roughly 1,000 of them. The "cable" systems average out at 800 subscribers each. Sixteen have more than 500 subscribers, and two serve more than 10,000 viewers each. It is estimated that about 2.5 million viewers use cable and are served by lines which, for the most part, carry five signals. A number carry only one, and others have as many as nine. Pennsylvania has the largest number of CATV systems, with 204 listed, while five states have only one.

Long before broadcast television, the present writer foresaw that one day we would have actual live theater in the home via closed-circuit TV. In his former magazine, *Television News*, in the January-February issue of 1932, he covered the subject under the title "The Tele-Theater." Instead of paying outrageous prices for theater tickets, viewers could see all important *live* Broadway shows *direct* from the theater via TV at 50 cents. If millions of people would view such Tele-theater shows at 50¢ a family, the theater entrepreneurs would soon grow rich. While this idea has still to be realized, a parallel series of enterprises has erupted quietly without much fanfare.

In Manhattan's Hotel Statler-Hilton, the Telad Corp. has installed a system whereby every one of the 2,200 hotel room guests can see a special program about sightseeing New York, shopping news from the big stores, gallery openings, all sorts of special New York events, weather and transportation information, theater news, special restaurant information—in short, everything that out-of-town visitors and tourists wish to know. This information is received on regular TV receivers, tuned to channel 6 (normally blank in New York City).

The program on channel 6 repeats every half hour. The company spots about 5 minutes of commercials for each half hour. Programs run 12 hours a day, seven days a week, starting at 8 AM daily.

Another company, Teleguide, will broadcast similar TV programs to 12 (or more) other hotels comprising some 12,000 rooms. This company will use channels 3, 6 and 10—all presently unused in New York City. Thus channel 3 will carry condensed programs in French, German, Italian,

Japanese, Portuguese and Spanish—30 minutes for each language, for guests who do not understand English.

In Washington, D. C., similar programs will be disseminated by another company named Hotelevision in two large hotels, the Sheraton-Park and the Shoreham.

There seems little doubt that other installations will be made very soon in all the larger hotels in the US. It is anyone's guess how many million old and new TV sets will thus be connected and interconnected in the near future.

The companies mentioned above have their plants either in the hotels or at outside quarters. In either case, they run their ½-inch-diameter coaxial cable to the hotels' master antennas for the necessary connections.

Of importance to these new broadcasters is the fact that, inasmuch as they do not utilize a radio frequency, they are not affected by FCC regulations. Presumably this may not always be the case in the future. Conceivably, if closed-circuit television becomes a nationwide big business in years to come, some Federal regulations may inevitably come about.

When the new closed-circuit TV broadcasters tapped the hotels for their new service, the major facilities were already in existence—all that was required was to connect the coaxial cable. Yet there is waiting the infinitely larger market—the *public at large*. How can this *well paying* market be tapped in the future?

While the cost of conduits and installing coaxial cable would be astronomical if a separate cable were to run to every home and every apartment individually, yet to be an economic success, such a TV system should not cost much more than the present system of electric light, gas or water lines. A number of "pay-Television" companies have tried various technical schemes to bring programs to subscribers. None has succeeded so far.

How will the housewife of the future shop via television in her supermarket or department store—a dream publicized by many forecasters for the past 50 years? From a technical viewpoint, there is nothing impossible about this. It can be done right now; it is eminently feasible—except for the fantastic cost.

The same thing is true of the writer's early Tele-theater. It, too, will become possible in the future.

How? The physical facilities are already in existence—but the technical problems have yet to be solved. Almost every home has a telephone service supplied by two wires. The same is true of the electric wire supply. The telephone companies, well aware of the television-via-wire service, have been working over that problem for several decades. Many patents are in existence, but the final breakthrough of phonovision has as yet to be realized. The chief obstacle so far has been to channel the necessary high frequencies over a pair of not too highly insulated wires. In other words, to eliminate the coax. Perhaps some semiconductor device will prove to be the key to the difficult problem.

Once the technical difficulties are solved, the economics will be solved automatically, too—even the billing of the closed-circuit TV service will be done by the telephone companies.

Will phonovision adversely affect broadcast television? Probably not in the slightest. It will simply be an adjunct—a supplementary service to broadcast TV—both decisively have their own spheres of utility.

—H.G.

Sun-tracking robot furnace



uses servo amplifier

A robot furnace or a light-seeking (or sound-seeking) robot can be built around this transistor servo amplifier

By TOM JASKI

A SERVO SYSTEM IS ONE IN WHICH A mechanical position or motion is controlled by a small input signal which often includes some negative feedback. Some form of amplification is an essential element in any servo system. Most servo systems today use electronic servo amplifiers which can control relatively large mechanical motions and forces with very small input signals, or by corrective (feedback) signals supplied by the controlled elements.

A great many kinds of servo amplifiers operate on different amplification principles. But all basically function on the basis of a signal at the input derived from the action at the output—the so-called closed-loop system. See Fig. 1.

Whether you wish to build a light-seeking robot or track satellites with an antenna, or perhaps wish to follow the sun with a mirror furnace (as was my plan), you will need some form of servo amplifier. The one shown is about the simplest I could devise, yet it is reliable, versatile and inexpensive.

Fig. 2 shows a block diagram of the amplifier and power supply. In my case,

the input signals were derived from two small solar cells for each of two motions. One is called a polar motion (rotation about an axis approximately parallel to the earth's axis). The other is a declination motion, which here meant primarily angle above the horizon.

Whatever you call it, one amplifier is needed for each motion. With two such amplifiers you can point an object (light-sensitive cell, microphone or what have you) in any direction you wish, depending only on the mechanical limitations of your system.

Circuitry

Fig. 3-a shows the circuit diagram of one servo amplifier (my complete system uses two amplifiers and one power supply), and Fig. 3-b the power supply. As you can see, the amplifier could not be much simpler. Each amplifier consists of three transistors per section, one potentiometer to balance the two halves and one polarized or differential relay. If you cannot obtain either a polarized or differential relay, two sensitive relays will do in its place,

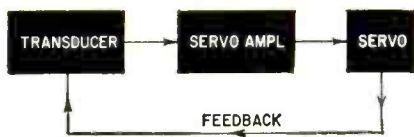

Fig. 1—Basic closed-loop servo system.

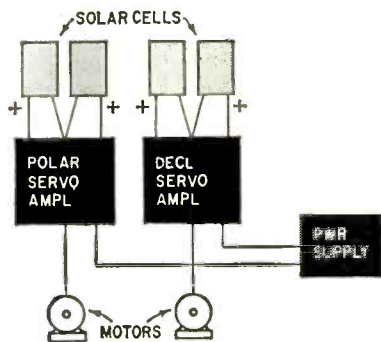

Fig. 2—Block diagram of servo system used to track the sun.

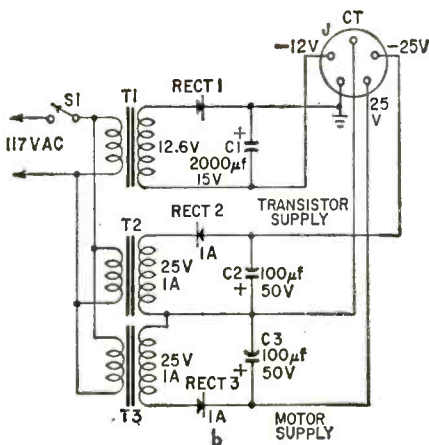
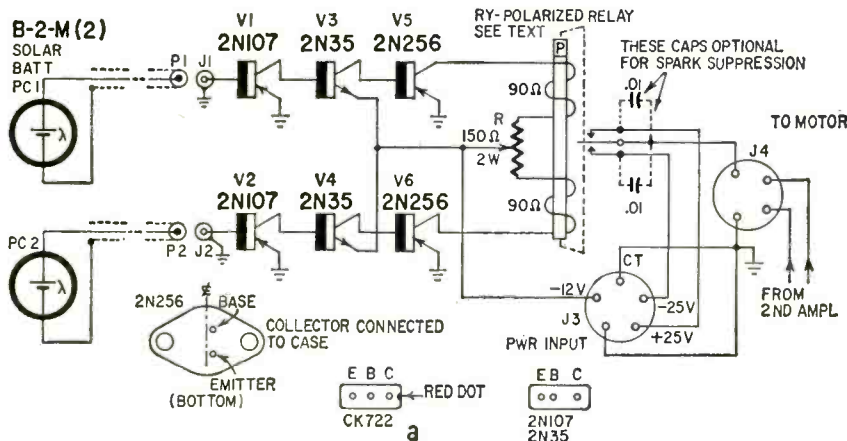

Fig. 3-a (below)—Schematic of servo amplifier (two are required for author's system); b (above)—power supply schematic. Output voltage of T2 must suit the motors used.



AMPLIFIER (Fig. 3-A)

- R—pot, 150 ohms, 2 watts, linear taper
 - V1, 2—p-n-p transistors (2N107, CK722 or equivalent)
 - V3, 4—n-p-n transistors (2N35 or equivalent)
 - V5, 6—p-n-p power transistors (2N256 or equivalent)
 - PC1, 2—solar cells (International Rectifier B-2-M or equivalent)
 - RY—2-coil polarized relay, see text
 - P1, 2—phono plugs
 - J1, 2—phono jacks
 - J3—5 contacts (Amphenol 86-CP5 or equivalent, see text)
 - J4—motor jack, number of contacts depends on number of motors used
- Above parts list is for one amplifier only.

POWER SUPPLY (Fig. 3-B)

- C1—2,000 μ f, 15 volts (Cornell-Dubilier A-0070 or equivalent)
- C2, 3—100 μ f, 50 volts
- T1—primary, 117 volts; secondary, 12.6 volts at 0.6 ampere or more (Thordarson 26F67 or equivalent)
- T2, 3—primary, 117 volts; secondary, 25 volts at 1 ampere (Stancor P6469 or equivalent)
- S1—spst toggle
- RECT 1—silicon rectifier, 100 ma or more
- RECT 2, 3—2 500-ma silicon rectifiers in parallel (Sarkes Tarzian MS00 or equivalent)
- J—output jack, 5 contacts (Amphenol 78-55 or equivalent)
- Cable to amplifier, 5 conductor with connectors on both ends (Amphenol 86-PM5 and 78-PF5 plugs or equivalents)
- Chassis for amplifier(s) and power supply, line cord and miscellaneous hardware

as will be shown. Each amplifier chain is a direct-coupled p-n-p n-p-n p-n-p sequence, now familiar in transistor literature.

With each side of the amplifier

receiving an identical signal, the output transistors pass the same amount of current (assuming both halves of the amplifier to be equal) and cause equal pull on both sides of the armature in the relay. As soon as one side receives more signal (as shown, or less signal with reversed input polarity), the output transistors pass different amounts of current through the relay coils. The armature is attracted to the side with the greatest current, closing a contact which causes a motor to turn in one direction. Closing the opposite contact would have turned the motor in the other direction.

If the input is a set of photocells or solar cells, and if your object is to have an equal amount of light on each cell, the correction to the system is applied at the input. (Rotating the cells will even the amount of light, causing the signals to become equal again and restoring balance.) Thus if the light moves away, as the sun does, and more light falls on one cell than the other, the system will follow the moving light.

If the input is some other system of voltage-producing elements, these must

also be balanced by the motor to make the system come to rest.

The photos show the amplifiers and power supply and one of my input cells. The construction of this cell is shown in Fig. 4. Two solar cells are set side by side on one side of a dark box (painted flat black inside) with a narrow slot in the opposite side of the box. If the box is pointed directly at a light, the cells are lighted equally. As soon as the box is pointed directly at a light, one cell receives more light. This unbalances the system and causes action. If the cells had been mounted in a longer box, with greater distance from the slot, a smaller angle of rotation would have obtained the same result. Thus, by making the input enclosure larger, the system becomes much more sensitive. In my case the short boxes were good enough to make the system active in bright sunlight with only a fraction of a degree of rotation.

Adjustments

This servo amplifier contains one paradox. Its greatest advantage is also its greatest disadvantage. It is a very versatile system, with wide latitude for inequalities in transistors, components, relays and input signals. On the other hand, this makes the system a little troublesome to adjust. Setting it up will require some patience. Current through the output transistors will be greatest with no input signal.

To adjust, you can shunt each input with a 100,000-ohm resistor, for example. Then—assuming the relay is balanced—balance the amplifier by adjusting potentiometer R. If that fails, swap transistors in each stage progressively (turn off the power before

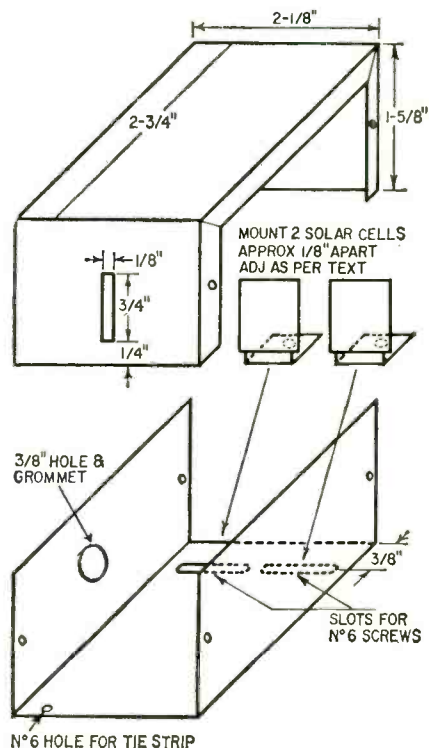

Fig. 4—Construction of solar-cell box.

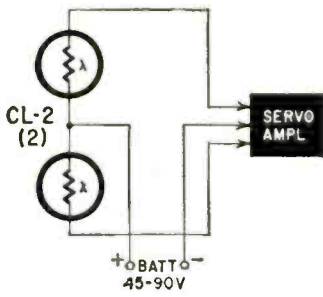
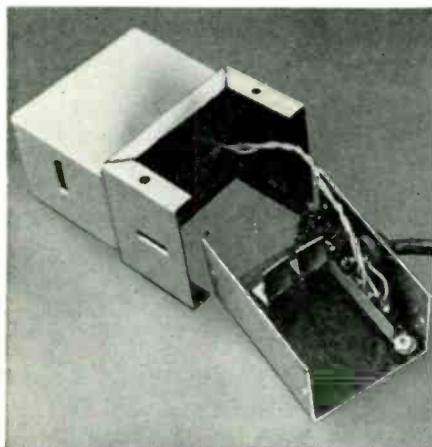

Fig. 5—Photocells and an external voltage source may be used.

withdrawing a transistor!), and try to balance the amplifier. If that also fails, there is always the relay adjustment. If you use the relays I indicate, there will be tremendous latitude in balancing, by adjusting the contact spacing or the holding magnets (or both) on each side. You can check initial relay balance by pushing the armature one way or the other. Even though the holding magnets may make the armature seem sticky on either side, it should return to center if the current is equal in the two coils. You can make sure of this condition by testing with the coils in series but opposing across a low-voltage source (3.5 volts will do).

[Western Electric 209 FJ relays were used by the author. These may be obtained as surplus from Red Johnson Electronics, 3311 Park, Palo Alto, Calif., or relay No. 255A at \$16 per unit may be ordered from Metropolitan Telecommunications, 9614 Dean St., Brooklyn 38, N. Y. These are two-coil polarized relays with a coil resistance of approximately 100 ohms.—Editor]

Each amplifier chain should give from 600 to 1,000 gain, depending on the condition of the transistors used. This means that with the relay shown, which requires a difference current of only 3 ma, a few microamps of difference at the input will activate the servo motor. Such a small current can be obtained from a set of photocells. Fig. 5 shows the diagram for a set of Clairex CL-2 photocells in place of the solar cells. The input could equally well be a pair of thermistors with a voltage source, but in that case the time required to



Boxes housing solar cells.

heat or cool the thermistors might slow the system down considerably.

This brings up the point of *hunting*. If the system is made very sensitive, and, as a result, quick-acting, it might overshoot the balance point, backtrack to correct and overshoot in that direction, and then again go forward, and so on, oscillating back and forth. This is called hunting. Eventually the system would come to rest because of the mechanical friction represented by the motor if for no other reason. But *any* hunting is undesirable. It can be corrected by making the system less sensitive, or less rapid, by introducing electronic "friction." This is most easily done by shunting the relay coils with large capacitors.

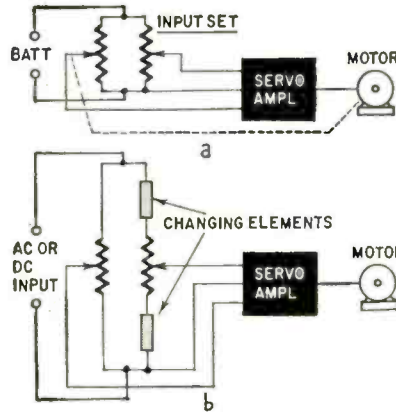

Fig. 6—Either mechanically unbalanced (a) or electronically (b) bridge may be used to supply input signals.

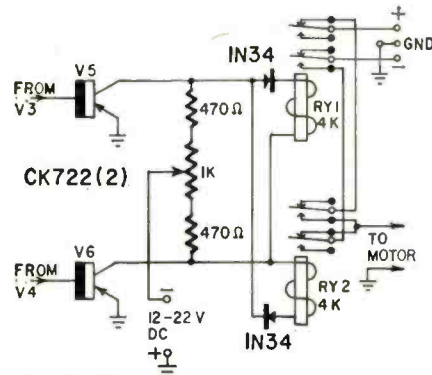

Fig. 7—Sensitive relays may be used in place of differential relay. Extra set of normally closed contacts is used to protect power supply in event both relays are energized.

The collector of the 2N256 is connected to the transistor case, so it must be insulated from the chassis.

Various inputs

Fig. 6 shows how the servo amplifier could be responsive to a voltage difference in a bridge circuit. If one of the bridge potentiometers is mechanically linked to the motor, the system will come to rest once the bridge is again balanced. The elements of the bridge can be any kind (other than the resistors shown) so long as they produce a dc imbalance, or an ac imbalance that can be rectified and filtered. If there is not enough filtering, the relay will chatter with the ac frequency. (I tried it!)

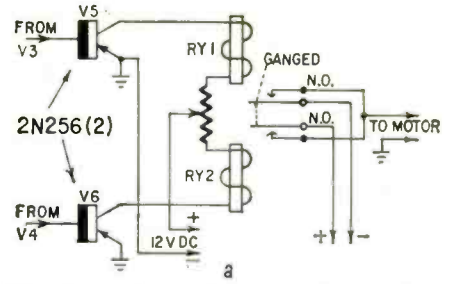
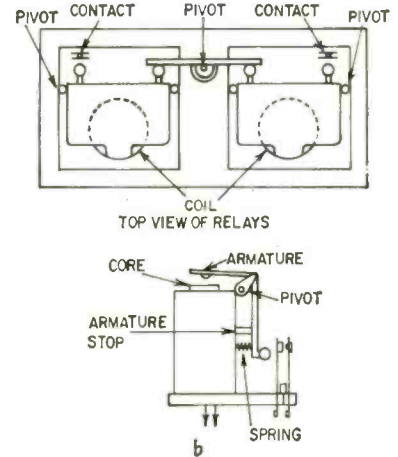

Fig. 8-a—Two relays may be used if armatures are linked (see text); b (below)—simplified sketch showing method of linking relay armatures.



To operate the motor with other than a polarized or differential relay, use the circuit shown in Fig. 7. Here two sensitive relays take the place of one polarized one, and the signal directivity is controlled by the diode rectifiers. An alternate is to use less sensitive relays, and simply circuit them as in Fig. 8-a, but the armatures then must be mechanically linked so that only one at a time can be attracted (Fig. 8-b).

To avoid overlap without the mechanical linkage in Fig. 7, each relay can energize a motor only if the other one is not energized. This can result in a "dead" spot if the relays have a great deal less holding than attracting current. Although differential relays and polarized relays also suffer from a "dead" spot, they are generally designed to have as little of this as possible. A single-coil polarized relay would be connected as shown in Fig. 9.

For more sensitive relays, the output transistors need not be power transistors. These were used because the

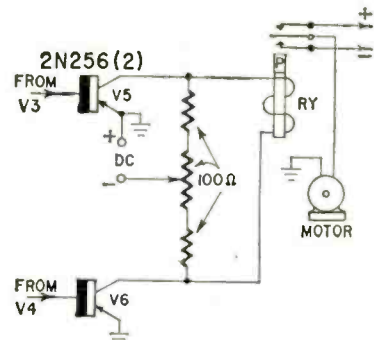
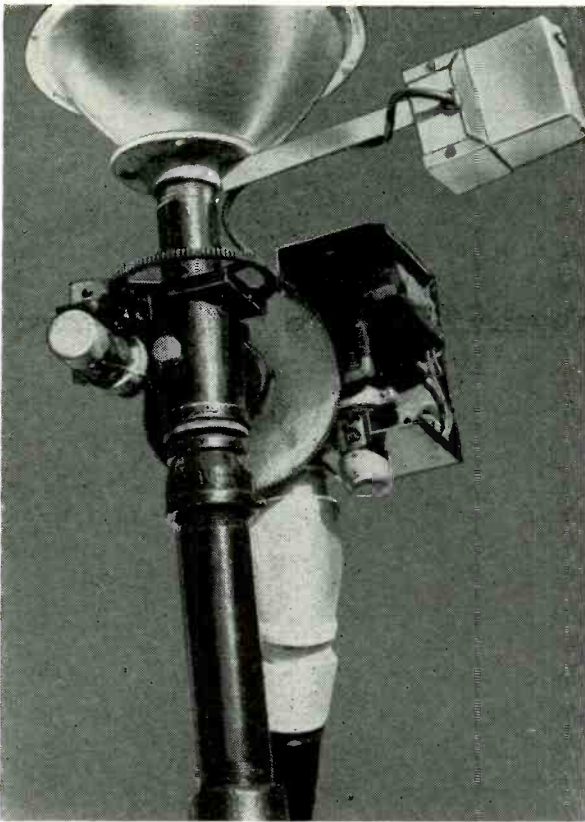
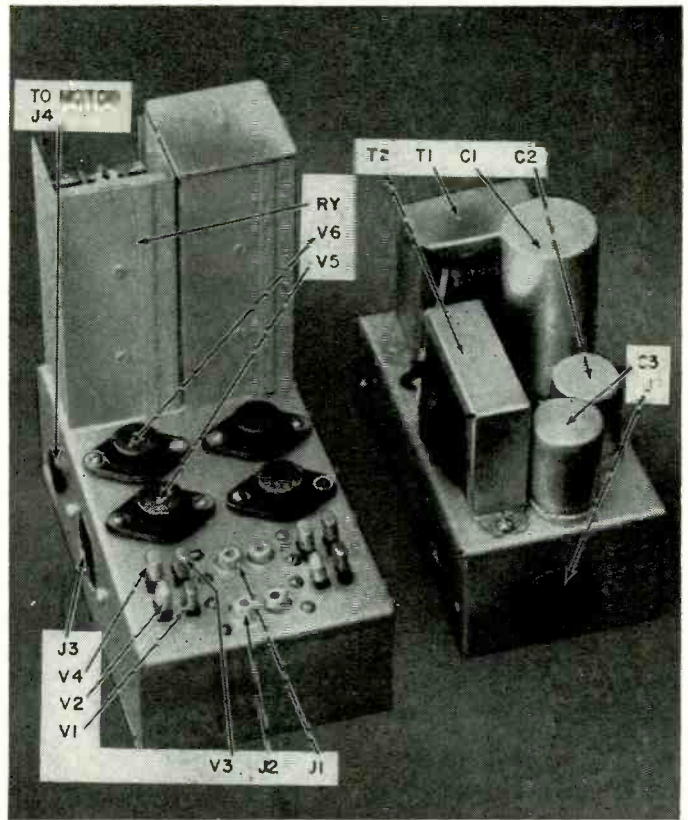

Fig. 9—A single-coil polarized relay may be used.



Motor and gear arrangement and solar cells mounted on rear of furnace.



Servo amplifiers (two) and power supply. Author eliminated transformer T3 by adding a second 25-volt winding to T2.

Underside of power supply and amplifiers. Selenium rectifier was used in author's unit because it was readily available. Parts and layout of second amplifier are same as amplifier No. 1.

coil resistance is around 100 ohms. With sensitive high-resistance relays, the output transistors could be the same as the input transistors (2N107's, CK722's or equivalent).

Mechanical construction is of course totally uncritical, with one exception. The two sets of transistors should be exposed equally to any temperature change, in which case the system is almost entirely balanced for this factor. With the sun falling on only one part of the amplifier, you might find the system working without any input signal.

To protect the power supply, a male chassis connector should be used on the amplifier rather than the female one (J3) used in the original model.

Whatever your plans—robots, sun follower, heliograph, bridge balance or followup system, wherever you need a servo amplifier, this one will very likely fill the bill. With all the ways of compensating for differences in transistor characteristics, it can be built with inexpensive transistors. Very economically, in other words. If in the last analysis you still have difficulties solving the balance problem, resistors in the base connections of the transistors help a great deal. Their values will depend on the inequality of your transistors. The larger the resistors, the more sensitivity you sacrifice. This does not matter too much. Unless you hope to track stars (requiring much more sensitivity than this unit can provide), there is enough to spare for most purposes.

END

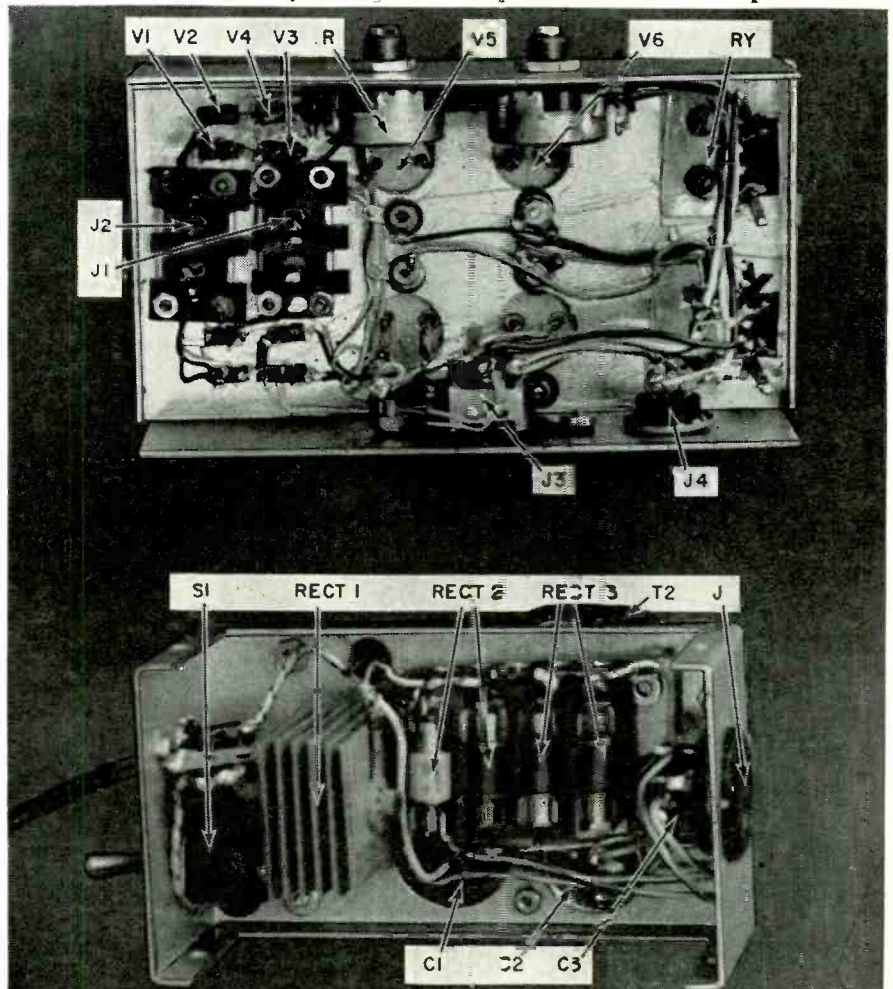

circuits for FM stereo

By NORMAN CROWHURST

What makes that FM stereo equipment work?

In the coming months RADIO-ELECTRONICS will cover every important or unusual circuit used for FM stereo. We will tell exactly how they are arranged and exactly how they operate. Detailed descriptions will accompany each schematic.

Our primary purpose is to show the many different forms taken to make FM stereo possible. This month circuits used by Sherwood, Pilot, Knight and Lafayette are presented. Others will appear in succeeding issues.

THE SHERWOOD CIRCUIT USES A REFINED FORM of switching. Like the others, the diodes attenuate the channel momentarily "unwanted", by about 18 db. This eliminates the diode characteristics from the performance figures. The cathode-follower triode with 19 kc tuned in its plate is a conventional input. A 19-kc oscillator uses cathode, grid and screen of the pentode section, while the plate doubles to produce 38 kc, which is transformer-coupled to the switching bridge. A 19-kc trap across the cathode resistor of the follower eliminates any residual 19 kc from

the composite, which is then fed to the center of the switching bridge.

The attenuation of the channel in which the diodes are momentarily conducting (by the instantaneous phase of 38 kc) is set very precisely by the 33,000- and the two 10,000-ohm resistors. The separation and balance adjustment in the cathode circuit of the two output tubes then produces virtually a perfect null at the plates, for left in right channel and vice versa. These plates feed through twin-T filters to remove 38-kc switching components and provide correct de-emphasis.

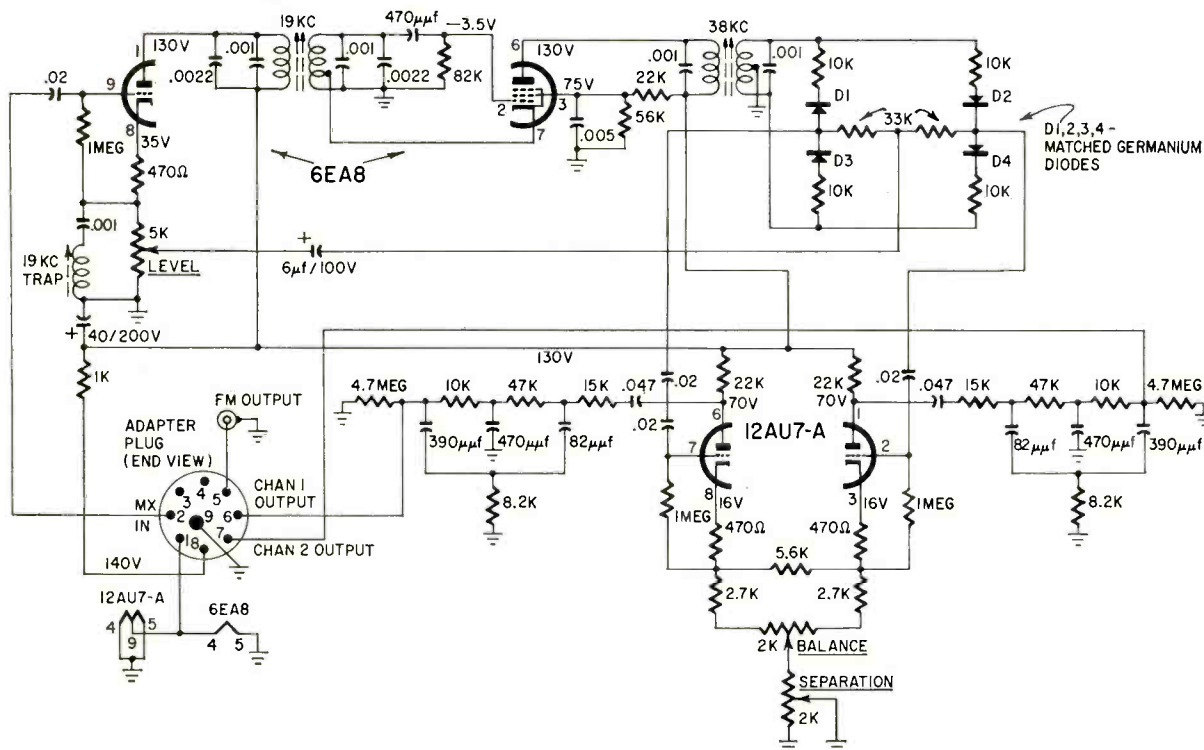

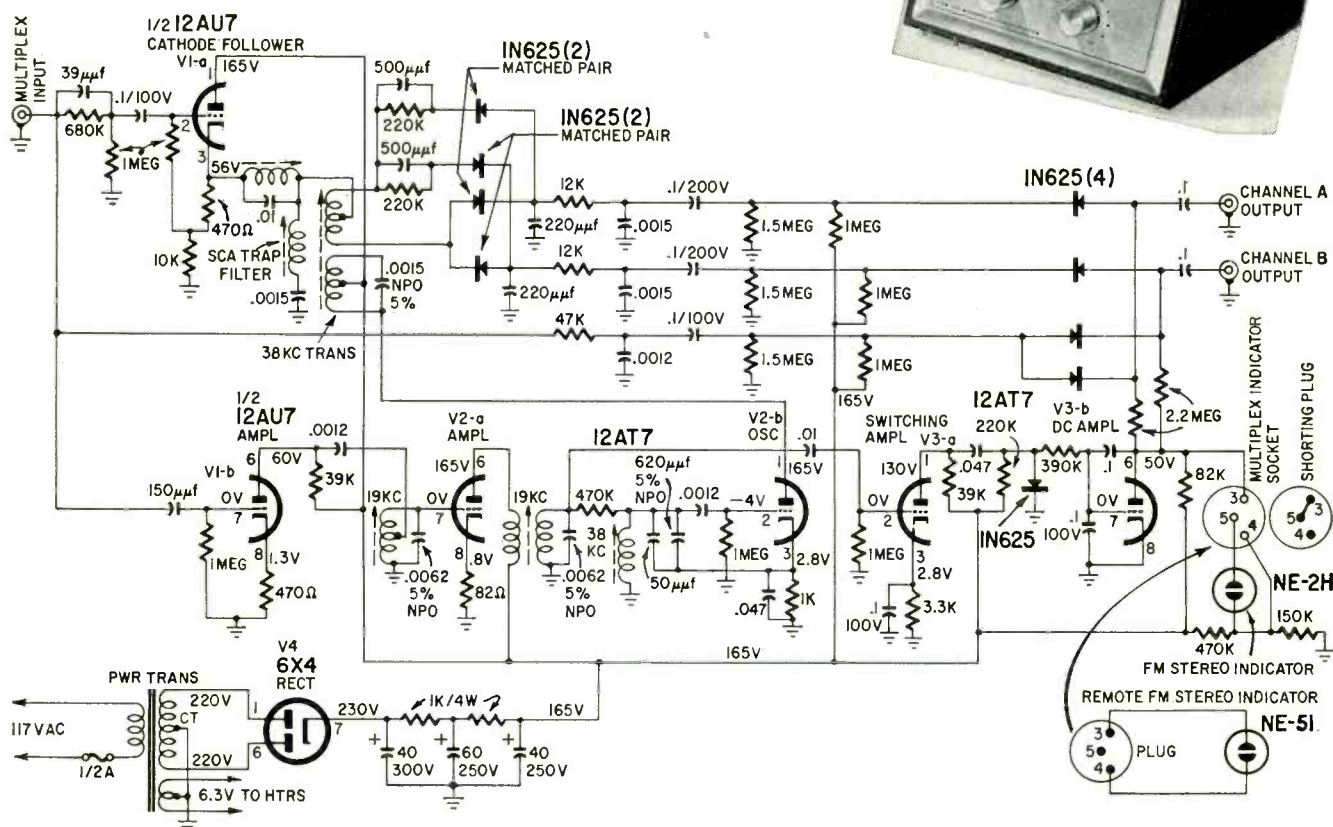

PILOT'S MODEL 200 USES SWITCHING WITH AN important difference. The cathode follower is fed with a high-frequency compensated divider. At the same time an amplifier stage feeds the 19-kc tuned amplifier that synchronizes the 38-kc oscillator. The 19-kc also feeds the switching amplifier which rectifies it for the dc amplifier controlling the relay.

In the earlier version of this circuit, the relay in the plate circuit of V3-b was mechanical. This has been changed to the solid-state circuit shown. A bias of three-fifths of B-plus is placed on the three lines isolated by 0.1- μ f blocking capacitors by 1- and 1.5-megohm resistors. In monophonic (no 19 kc) the plate of V3-b is less positive than the lines, so the top two diodes are nonconducting, isolating the stereo channels from the output, while the bottom two are conducting, making a connection (for audio purposes) directly through the 47,000-ohm resistor.

In stereo, the 19 kc makes the plate of V3-b more positive, so the top two diodes conduct and the bottom two don't. Now stereo channel connections are made, and the monophonic connection is open. This change in voltage also oper-

ates the neon indicator. The regenerated 38-kc is fed to the double-wound transformer whose secondary (and primary) has a center tap.

The composite from the input cathode follower feeds through the SCA rejection filter to the secondary center tap of the 38-kc transformer. The two 220,000-ohm resistors, each shunted by 500 μ f, maintain a charge close to the instantaneous peak value of 38 kc. Thus the matched pairs of diodes each conduct for only a short period near the peak of the 38 kc in one direction. When each conducts, it lets a sample of the composite fed in at the center tap through to the channel connected to that diode junction.

Where other switching circuits deliver half the composite waveform, on a time-division basis, to left and the other half to right, this circuit delivers just a short-time peak of each, when the 38-kc modulation (coming in from the transmitter, as distinct from the regenerated subcarrier) is at the point on left or right waveform, as the case may be. This avoids the reduction in L - R as compared with L + R inherent with normal switching circuits, and so does not need a separation adjustment to compensate for it.

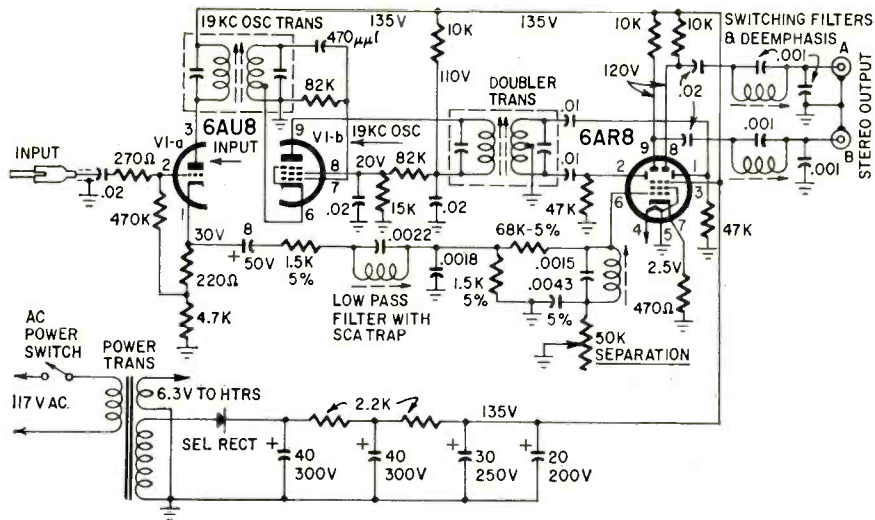

THE KNIGHT SELF-POWERED KN-MX ADAPTER uses an input stage that is cathode follower for all but the 19-kc pilot, which is tuned in the plate and coupled to a 19-kc oscillator, using screen, grid and cathode. This gives an input impedance of more than 5 megohms. Composite stereo from VI-a's cathode is fed through a filter to remove

SCA subcarrier and a further filter that partially shapes sidebands to the grid of a beam-switching 6AR8. The plate circuit of the tube used as a 19-kc oscillator doubles frequency and feeds the beam switching electrodes with push-pull 38-kc. The plate circuits of the 6AR8 include filters to remove switching frequency and deemphasis.

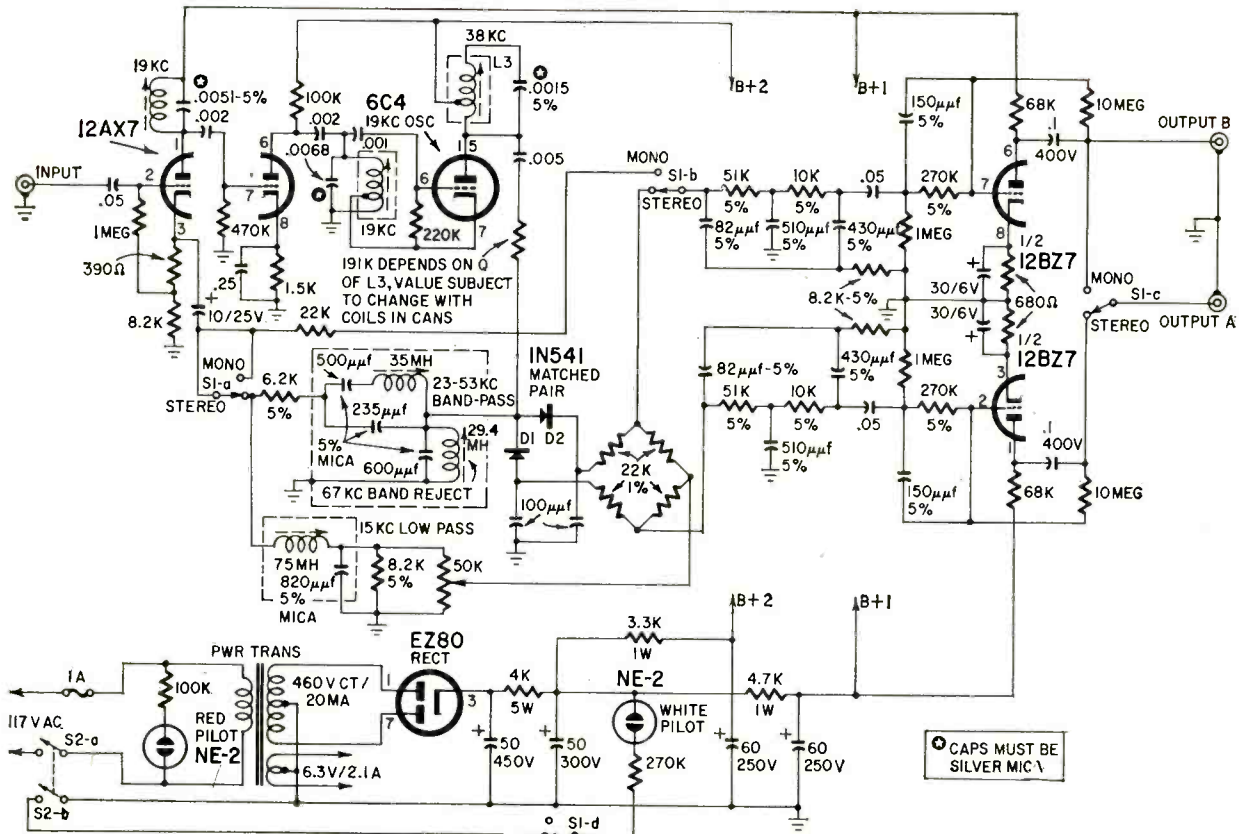

THE LAFAYETTE LT-200 ADAPTER RETURNS TO the matrixing concept. It uses half a 12AX7 as cathode follower, with the 19 kc tuned at the plate. Input impedance is about 10 megohms. The follower divides to feed the 15-kc low-pass filter (for L + R) and a 23- to 53-kc band-pass filter, with 67-kc rejection. Output of the latter is rectified by diodes D1 and D2 in opposite phase, to produce L - R and R - L. These outputs are combined in a matrixing bridge with L + R (after a separation adjustment

in the L + R channel) to give L and R. The subcarrier is regenerated by a 19-kc oscillator (6C4) with 38-kc tuned plate circuit to pick off the doubled frequency. This 38 kc is fed into the output from the bandpass filter. Each channel feeds through a twin-T circuit to an amplifier stage with voltage feedback. Mono-stereo switching bypasses filters and uses the left-channel output amplifier on mono, paralleling the output jacks so both are the same.

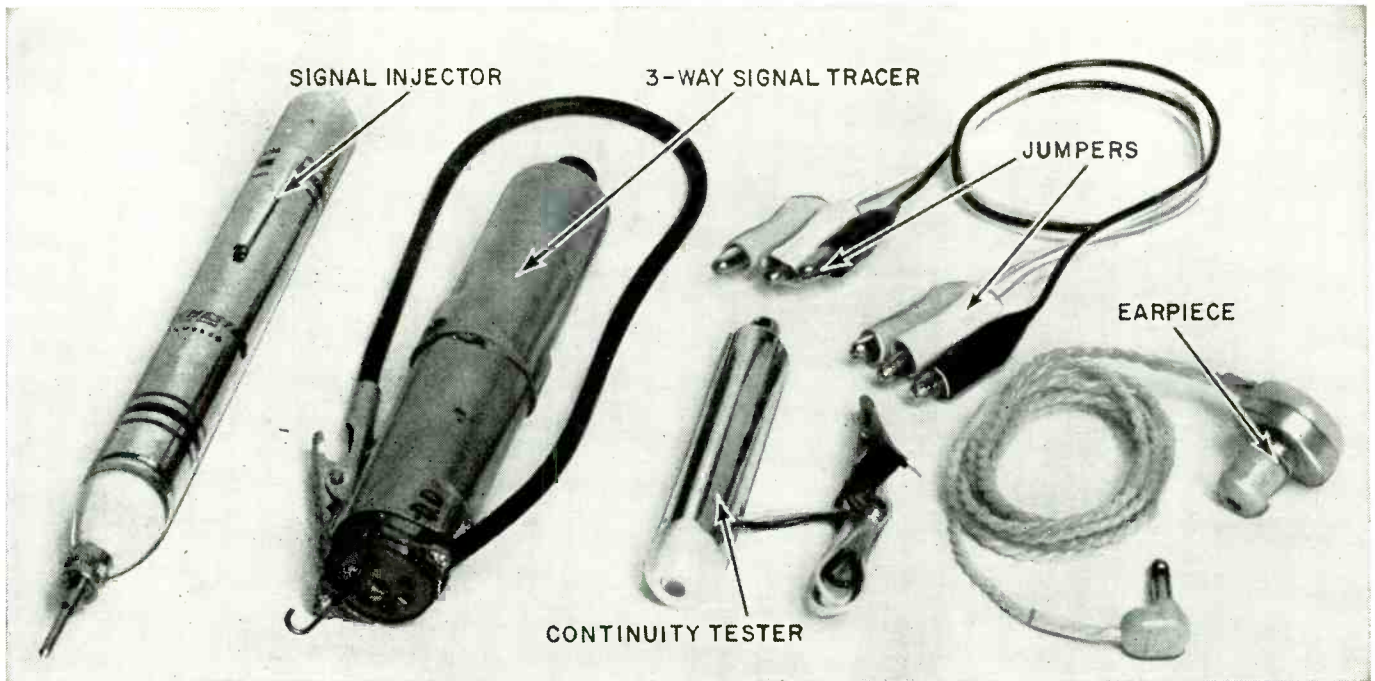

industrial technician's Pocket Kit

7-piece service kit includes signal tracer, signal injector, continuity tester, jumpers and an earpiece

By LEO LAZARUS

EVERY FACTORY ELECTRONIC TECHNICIAN can use a basic kit suited to his needs to avoid frustration in his work and to gain recognition as being competent in his field.

Contrast the usual way the electronic technician equips himself for his job as compared with skilled craftsmen in other fields. They have to provide an extensive range of tools at considerable expense to themselves. Compared with them, "our" man arrives at his job empty-handed. Yet by the very nature of his own skill he can provide himself, at minimal cost, with aids that are just as useful to him as the chisel to the carpenter or the calipers to the machinist.

Despite the small amount of money involved, very few technicians use these devices on their jobs though many

of them have similar gadgets for home experiments. There seems to be an axiom in the electronic field—what the firm does not provide, do without.

How will this tool kit be useful? Very rare is the company which has an abundance of test equipment. Having worked in different plants on the production of equipment for home entertainment, industry and government, I have yet to find anything but shortages. This condition becomes especially acute when one works in the home consumer section of the industry. The pattern goes somewhat like this:

The firm plans a new production run. The pilot models have been made, tested, modified, tested again, and pronounced satisfactory. The unit goes into mass production, and the call goes out for more technicians. Now there is a sudden increase in the number of people who want to use the scopes and meters which were already in short supply. But this is not all.

What you need

When there is multiple hiring usually some inept or inexperienced personnel are acquired. Thus, after waiting in line for the multimeter, you get it with a blown fuse. And all you wanted it for was to test for a short! Why not have a simple continuity checker of your own? It will save your time and sanity. And most important,

it will be there when you need it!

There are the numerous times when you want to jump, ground out or temporarily hook up a component. I always see these jobs done with solder and iron. In a busy shop, jumper leads are never to be found. If there ever were any, they long since found their way to the lab. Carry your own jumpers; in fact, carry three! They are as useful as a third hand.

You get a dead set from the production line. All tubes are lit, B-plus is

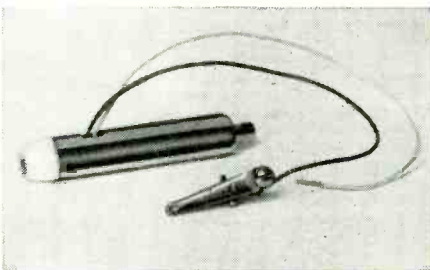

This little flashlight doubles as a continuity checker.



The completed signal injector.

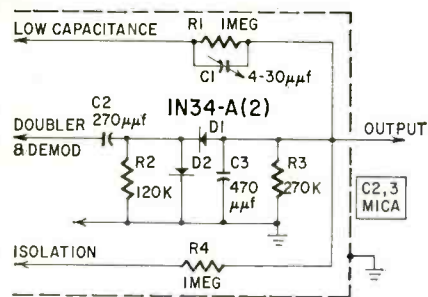

R1, R4—1 megohm
 R2—120,000 ohms
 R3—270,000 ohms
 All resistors 1/2 watt, 10%
 C1—4-30 μf trimmer
 C2—270 μf, mica
 C3—470 μf, mica
 D1, D2—IN34-A
 Case—See text

Fig. 1—Signal-tracing probe has low-capacitance, doubler and demodulator, and isolation probe functions.

there, and the obvious possible shorts check out. Find the dead stage by injecting a signal and tracing it through. My signal injector is a transistorized multivibrator probe built into the body of a Winchester Traveller penlight. The 3,000-cycle audio square wave provides rich harmonics high into the rf range at the flick of a switch. When I want to hear the signal, I just clip on to an appropriate point with a hearing-aid type phone. My earphone is so sensitive that the multivibrator output can be heard directly at the probe tip. Because of this, I recommend a sensitive phone just so you'll know when the multivibrator has stopped oscillating. Some time in the future the battery will run down, even if the unit stops for no other reason, and a scope may not be handy. For most signal-tracing purposes, the cheapest phone will do.

To round out our tool kit, signal-tracing probes to suit the individual needs are a must. I made three probes in one body, with provision to add more if needed.

The signal tracer

All items can be made from easily obtainable commercial components, and a small drill is the only metal-working tool needed.

The signal-tracing probe (Fig. 1) is wired on a piece of perforated circuit board cut to fit snugly into a JAN type TS 102U03 tube shield. The probe housing is made from two of these shields placed end to end. Modify one shield by cutting the bent flange at the top in several places, and straighten it almost in line with the sides. Then push the second shield down over the straightened flange portions so it fits firmly. Finally, solder in two places.

Next take a JAN type 7-pin miniature tube socket with a shield base. Reverse the shield base (this is easy to do) so the socket pins are inside. Connect each probe input on the circuit board to a separate socket pin, and note which is connected to which.

For the other end, cut from a piece of 1/16-inch plastic a disc a little smaller than the inside diameter of the probe housing. I used the top of the plastic cylinder that Ungar soldering tips are packaged in. Burn or drill a

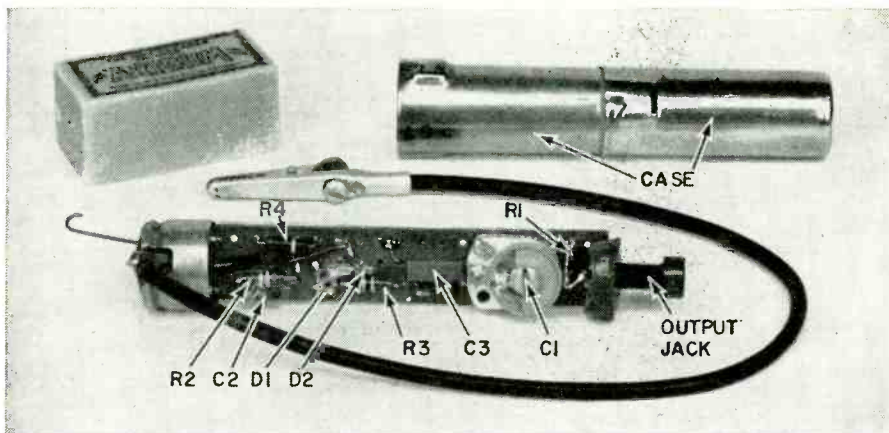

Inside the signal-tracing probe.

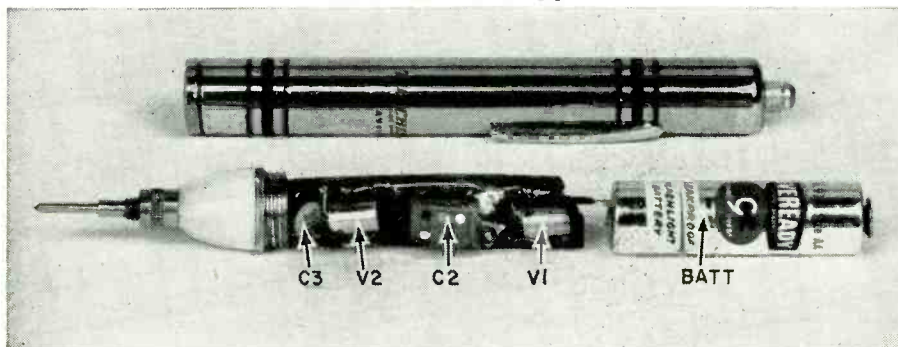

One side of the chassis inside the signal-injection probe.

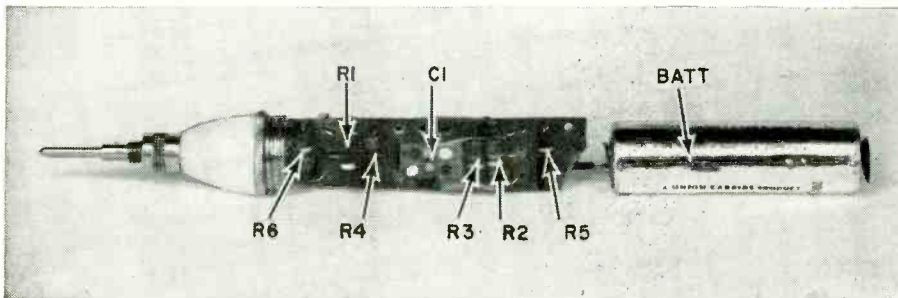

Most of the resistors and capacitors are on this side of chassis board.

hole in the center of the disc to take a Johnson nylon tip jack. If the hole is slightly small, the jack will cut its own thread. Otherwise, use the nut to hold it in position. Now solder the common probe output to the jack terminal, and the probe is ready for assembly.

Use one of the springs that are normally inserted in these tube shields in its normal position against its retaining flange, then place the circuit board with the disc against the spring. Now push on the housing over the shield base with the usual twist fit and everything will fit very firmly. The output jack will fit a meter or scope probe tip nicely.

For the multiprobe tip, cut about 1 1/2 inches of a paper clip so that you take in the bend portion. The bend will give a ready-made hook to hook on to component leads, and also something to grip with the fingers when changing tip positions. The probe you want is selected by inserting the tip in the appropriate tube-pin socket. If the tip is a loose fit, tin it with solder until it fits firmly. Connect a ground lead to the mounting hole of the tube base, which in turn is connected to the probe circuit ground. Drill a hole opposite

the variable capacitor in the low-capacitance probe so it can be adjusted.

Signal injector

The circuit of the signal injector is in Fig. 2. Any audio-frequency transistors should work in this circuit. I used the only two transistors I had on hand. The waveform is unbalanced, but that is not important here. If you have

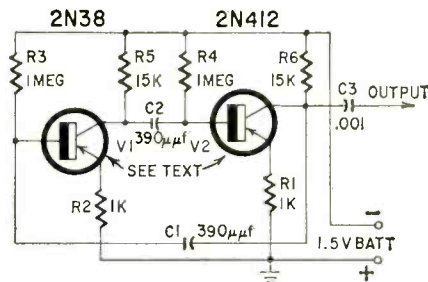

R1, R2—1,000 ohms
 R3, R4—1 megohm
 R5, R6—15,000 ohms
 All resistors 1/2 watt, 10%
 C1, C2—390 μf, mica
 C3—0.001 μf, ceramic
 BATT—1.5 volts, AA penlight cell
 V1—2N38 (see text)
 V2—2N412 (see text)
 Case—See text

Fig. 2—Circuit of the two-transistor signal injector.

By DONALD L. STONER

to buy the transistors, get two of the same type. If the 2N38 is not available, use a 2N34, 2N109 or similar type.

As with the signal-tracing probe, I used easily obtainable commercial components for the probe housing and all other sections. I got a Winchester penlight and disassembled it. The bezel type nose takes a standard insulated phone-tip plug, which is the probe tip. Only $\frac{1}{8}$ inch of the bakelite screw-on insulator acts as a retaining nut.

The circuit is wired on the same type of perforated board used for the signal tracer. The width is cut to fit the penlight case, and the length so the circuit board and one penlight cell fill the space normally occupied by two. Keep the circuitry in a little from each end of the board to allow for trimming. To use, clip one of your jumper leads to the pocket clip for a ground connection to the circuit under test.

I found that when the battery weakened to about 1.2 volts, the multivibrator would not start on closing the switch. I also found that momentarily grounding the junction of C1 and R3 never failed to start oscillations. To provide for this, I drilled a small hole in the penlight case opposite the junction of C1, R3. When the occasion arises, I just poke at the lead with any piece of wire I have on hand and the multivibrator never fails to start.

Those who do not want to go to the trouble of a perfect fit in the housing can solder a thin lead to the positive terminal of the battery from a ground point of the circuit. The multivibrator is always on, but so little current is drawn that battery life is long.

An alternative is to do what I did and use the penlight on-off switch to switch on the multivibrator. This entails soldering the round portion of a ground lug to the positive terminal of the battery to give a wider contact area and make sure the housing is in firm contact with the circuit ground when slipped over the circuit board.

Build the circuit breadboard style first to make sure your components work. With some transistors, 1.5 volts may not be enough to start the multivibrator oscillating. Check this by temporarily hooking in 3 volts. If it still does not work, recheck the wiring.

The earphone (Lafayette MS-260) has a .001- μ f blocking capacitor (small disc type for compactness) in series with the hot lead, and alligator clips to clip on with.

The continuity checker is another penlight or a single-cell novelty light serving a dual purpose. As a flashlight it will always be valuable. For use as a continuity checker, drill a small hole in the case so you can insert two thin, insulated leads that can be fed through and soldered to the respective positive and negative points. Now when the other ends of the leads are stripped and touched together, they bypass the switch and the bulb lights. Some novelty lights are of odd shapes and provide plenty of room to run leads in.

This is my suggested service kit, and it is just a handful. END

LICENSE-FREE radio control

Check the FCC regulations; you'll find you can operate without a license

ALTHOUGH IT IS NOT GENERALLY KNOWN, you can operate a radio-controlled model *without a license*. Anyone who has taken the time to read paragraph 15.205 of "Part 15—Incidental and Restricted Radiation Devices" of the Federal Communications Commission Rules and Regulations will discover that a low-power *communications device* may operate between 26.97 and 27.27 mc (27.12 mc \pm 150 kc) provided it complies with the following requirements:

- ▶ The carrier of the device shall be maintained within the band 26.97 to 27.27 mc.
- ▶ All emissions, including modulation products below 26.97 or above 27.27 mc, shall be suppressed 20 db or more below the unmodulated carrier output.
- ▶ The power input to the final radio stage (exclusive of filament or heater power) shall not exceed 100 milliwatts.
- ▶ The antenna shall consist of a single element that does not exceed 5 feet in length.

The intended use is not specified and thus Part 15 radio-control equipment may be considered permissible. Note also that no specific channel assignments are made (subpart a) and that any frequency between the limits specified can be used. The carrier frequency could be "wedged" between two Citizens band channels where interference is at a minimum.

There is one other point which should be mentioned in connection with the rules and regulations: Part 15.208 (d) states, "The certificate may be executed by a technician skilled in making and interpreting the measurements that are required to assure compliance with the requirements of this part." Thus, if you are technically qualified to make the required measurements (second harmonic, modulation bandwidth, power input, etc.), you can build a transmitter or modify a commercial unit. No second-class radio-telephone license is required. However, if equipment is found to be operating improperly or in violation of regulations, then the certifying person may be called for a hearing before FCC examiners. If he is found to be *unskilled* in making and interpreting measurements required for certification, then he may be prosecuted.

Although the power input of equipment used under Part 15 is limited to 100 milliwatts (0.1 watt), this is adequate for up to 1-mile range. Radio-control transmitters are usually operated with a continuous carrier. Only the tone is pulsed to actuate a receiver escapement or relay. This system is more reliable since the carrier tends to override interfering stations. Experience has shown that battery-consuming high-power transmitters are not required since the model seldom goes

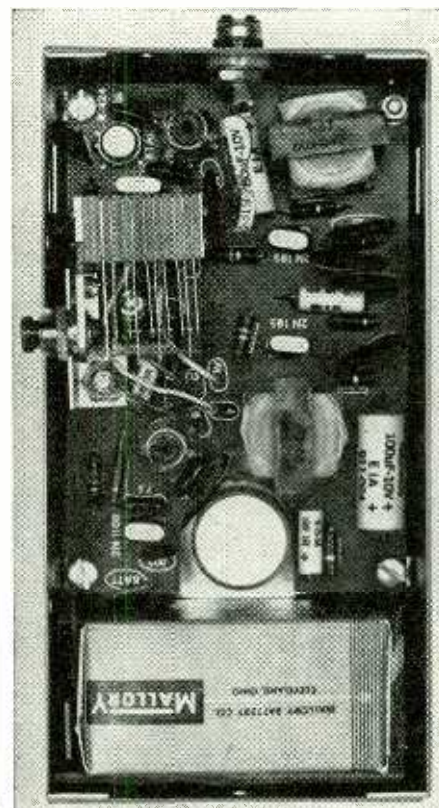

Inside the CW-30. This unit is about to be modified for license-free R/C use.

Fig. 1 — Circuit of the Heathkit GW-30.

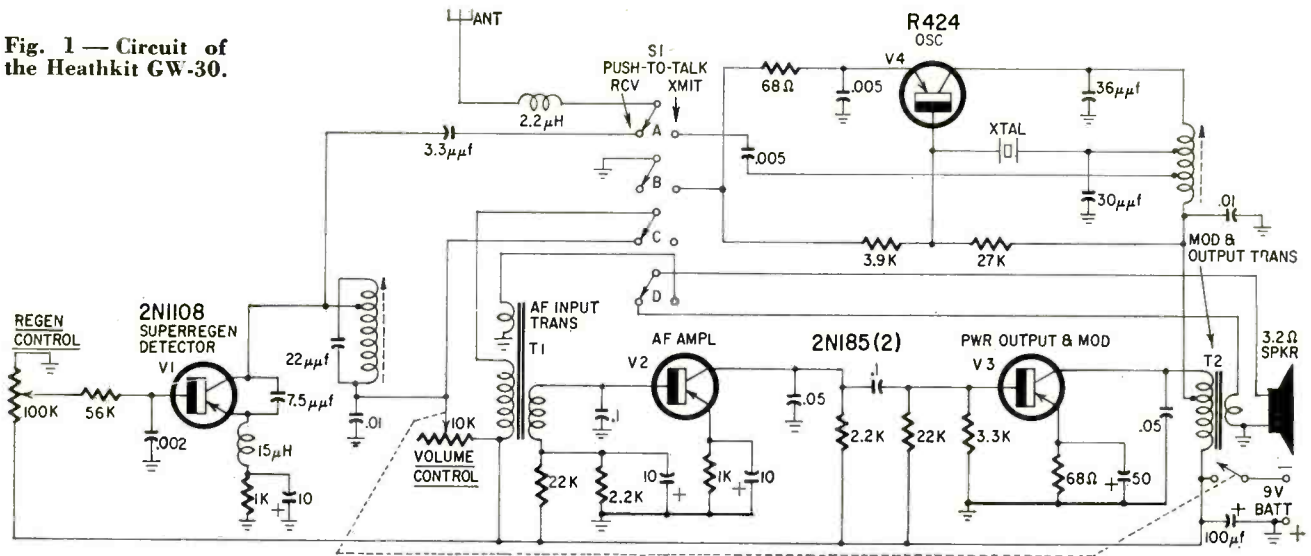

more than 1/2 mile away. Modern transistor receivers are more selective and sensitive than their vacuum-tube predecessors. Completely transistorized receiver and transmitter systems are not only practical but are commercially available (Wen-Mac, etc.).

A Part 15 R/C transmitter

To prove that a low-power transmitter could be used for radio control, a Heathkit GW-30 Citizens-band transceiver was modified to work in conjunction with a transistor radio-control receiver, an F & M Electronics Pioneer model. The circuit of the GW-30 is shown in Fig. 1.

The modifications involve disabling the GW-30 receiver and inserting feedback in the modulator section to generate a tone. The transmitting frequency of the GW-30 need not be changed.

Here's how to modify the GW-30. Take the unit out of its leather case and remove the back panel. Lift the printed-circuit board from the case after removing the three screws that secure the chassis. Familiarize yourself with the location of the pushbutton switch contacts (Fig. 2 and the photograph). This switch is modified so the transmitter carrier comes on when the volume control-switch is turned on. Depressing the button, in the modified GW-30, then produces a tone rather than turning on the carrier.

It is easier to bend the switch contacts than to rewire the switch to do this. They may be straightened later if a return to the original operation is desired. Note the dotted lines in Fig. 2. Bend the fixed contact on section B up so it touches the moving contact. This completes the emitter circuit of transmitter transistor V4. Next bend the fixed contact on section C up. This breaks the primary circuit of T1 and disables the receiver. Do not modify section D. Finally, on section A, bend the upper fixed contact up to clear it from the moving contact. Bend the lower fixed contact of section A so that it touches the moving contact at all times. This connects the antenna to the

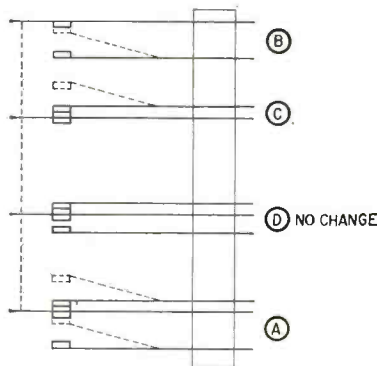
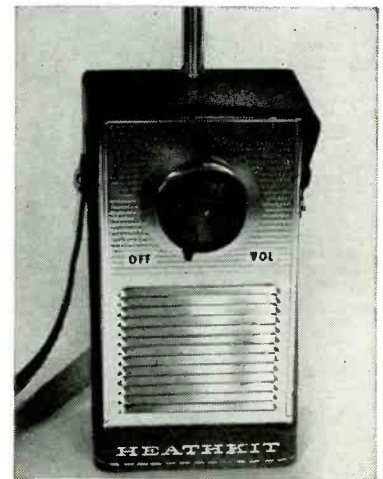

Fig. 2—Detailed view of the modified switch.

transmitter section. Finally, the modulator is made to oscillate by introducing feedback.

This can be done by reconnecting section D of the switch to tie the modulator output to the input. Locate the wires which connect section D to the speaker and T2. Reverse these two wires by "swapping" the connections from section D of the switch on the circuit board. Thus you can see that when they are connected in this manner, depressing the pushbutton connects the speaker winding on T1 to the speaker winding on T2. When this is done, the audio stages break into oscillation and tone-modulate the transmitter. This completes the changes to the unit and it can now be reassembled.

Although the modifications sound complicated, it actually takes more time



The GW-30 handheld CB transceiver.

to tell how to make them than to do the job.

To test the conversion, check the transmitter by energizing a radio-control receiver in a model on the ground. It should actuate the control surface reliably over a distance of 1,000 feet and more when the model is held aloft. In operation, the transmitter is energized, before launching the model, by turning on the volume control. As soon as the model is 50 to 100 feet from the transmitter and has enough elevation, the control button can be depressed. The exact sequence of operation will depend on the escapement used. END

“CENSORED”

may be a horrible word. But when applied to mail order tube advertising in Radio-Electronics, it protects readers from receiving seconds or rejects, when they believe they are buying new tubes. All mail order tube ads must specifically state the condition of the tubes offered for sale . . . new or used, seconds or rejects.

Power Measurements with your Scope

A scope will show you many things a wattmeter doesn't and will work where a wattmeter can't be used at all

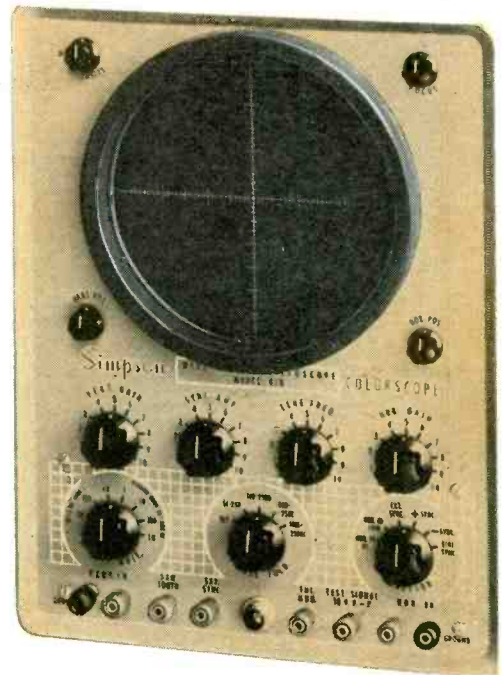

HUNDREDS of important scope applications in electronics work are unknown in many shops. This is not surprising, simply because the field of electronics has become so large. Let us start with a few more basic applications.

A scope can be connected to show either the voltage waveform or the current waveform in a circuit. For example, Fig. 1 shows the appearance of the voltage and the current in a simple neon-lamp circuit.

What do these waveforms show? The current waveform (Fig. 1-b) shows that the neon lamp conducts over a part of the complete cycle. The horizontal line through the pattern is the zero-current level. While the spot is moving along this level, the neon lamp is not conducting.

We see that the lamp jumps suddenly into conduction from the zero-current level. There is a sudden tall spike of current when the lamp ionizes. Thereafter, a sine wave of current flows until the lamp extinguishes. The current is zero for a time; then the sequence is repeated through the negative half-cycle.

The voltage waveform (Fig. 1-c) shows that a clipped sine-wave voltage is dropped across the neon lamp. The resistance of the lamp is practically infinite until the moment of firing. At the instant the tube ionizes, its internal resistance falls suddenly to a low value.

Although the current flow through the tube is changing, the voltage drop across the tube remains practically constant. This is an interesting property of gaseous conduction.

Note that a voltage spike precedes the clipped portion of the voltage waveform. In other words, the striking voltage is greater than the conduction voltage drop across the tube. We see from this why a current spike appears in the current waveform, preceding conduction.

Voltage vs current

Thus, we know that there are voltage waveforms, and that there are current waveforms. Another important type of waveform is the power waveform—a voltage vs current pattern. Let us see what this means.

If we have a load such as a motor connected to an ac line, it draws more or less real power from the line. An induction motor draws a lagging current. A synchronous motor draws a leading current. An ideal motor draws an in-phase current. A suitable combination of motors on a line is practically the same as an ideal motor. In-phase current is drawn from the line, and the power company is happy.

Let us look at Fig. 2. Here, the scope's vertical input terminals are connected across the line—line voltage is applied

to the vertical amplifier. A small resistor, R , is connected in series with the line. The scope's horizontal input terminals are connected across the resistor—line current is applied to the horizontal amplifier.

The load is a capacitor. A nearly circular pattern is displayed on the scope screen. In this arrangement, the pattern means that the current is 90° out of phase with the voltage. To put it another way, the current does no work. It merely surges in and out of the capacitor, back and forth in the line. All the power in the circuit is reactive power. The rule is: *If the power pattern is a circle, no real work is being done by the circuit.*

Next, let us look at Fig. 3-a. Here we have a resistive load R_L . It might be a bank of lamps, for example, or some device that "looks like" a resistor. The scope is connected as before—vertical deflection corresponds to line voltage, and horizontal deflection to line current.

We see a straight diagonal line on the scope screen in Fig. 3-b. This pattern tells us that there is 100% real power in the load. There is zero reactive power. All the current is doing work. It is converted completely into heat by the resistor. No reactive power is surging back into the line.

In many practical electronic configurations, both real power and reactive

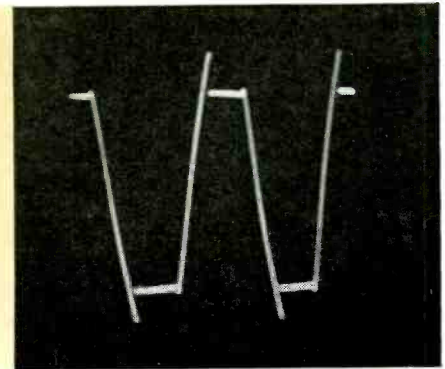
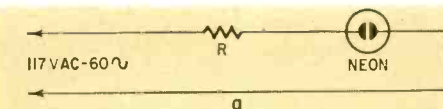
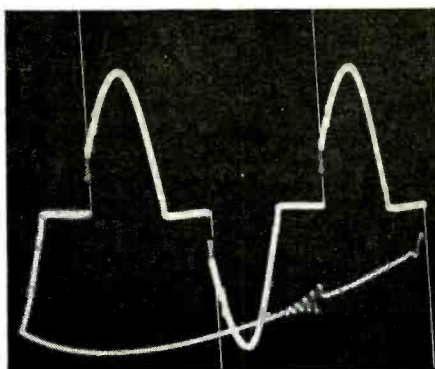

Fig. 1—A simple neon-lamp circuit (a) and its current waveform (left) which is seen when the scope is connected across resistor R . The voltage waveform (right) is seen when the scope is connected across the neon lamp.

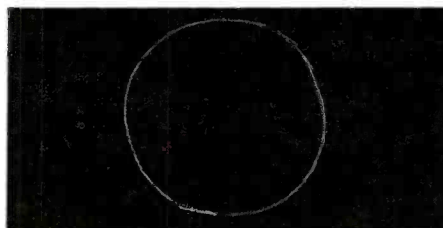
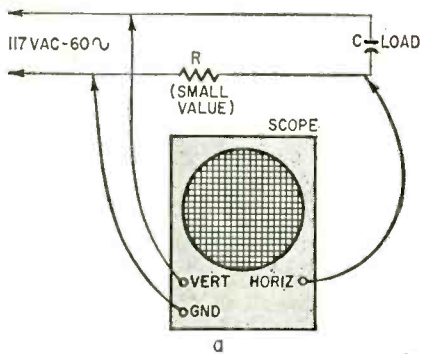

Fig. 2-a—Load across line is capacitor. Scope connected to show voltage vs current (power) waveform. **b**—Nearly circular pattern shows practically no real power is drawn from line by capacitor.

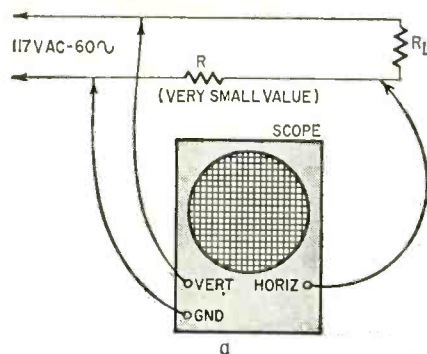

Fig. 3—Scope connected to check power in resistive load R_L (a) produces the straightline pattern (b) that shows 100% real power in the load.

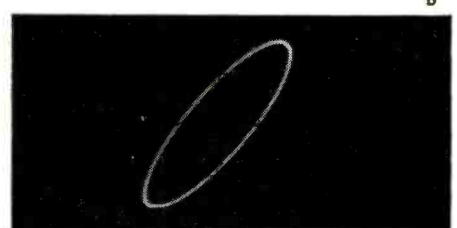
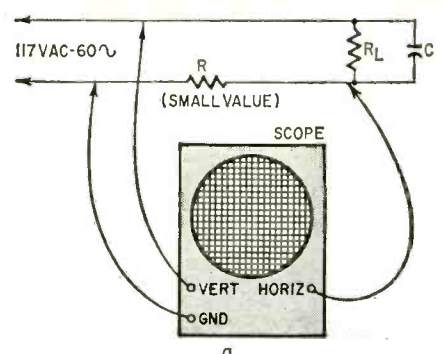

Fig. 4—This basic circuit (a) takes both real and reactive power from the line and produces an elliptical pattern (b).

power are present. In other words, the real power is doing work. The reactive power is merely taking current and returning the same current to the line. This situation is shown in Fig. 4. The current drawn by resistor R_L does work in heating the resistor. On the other hand, the current drawn by capacitor C is merely stored for a short time and then returned to the line. This surging current corresponds to reactive power.

This time the scope pattern is an ellipse. In other words, the pattern is between a line and a circle. The amount of area in the ellipse, compared with the area in a circle, indicates the amount of real power compared with the reactive power. If we choose, we can measure the vertical and horizontal deflections, to determine the power factor, and find the exact amounts of real and reactive power.

Non-sine-wave current

In many electronic circuits, a current sine wave does not flow when a voltage sine wave is applied. A rectifier tube, for example, changes a sine wave into a half sine wave. Thus, many scope patterns are not as simple as those discussed above.

Let us consider the simple power supply shown in Fig. 5. A scope is con-

nected to show current flow into the circuit in terms of vertical deflection, and to show output voltage in terms of horizontal deflection.

Fig. 6 shows how the scope pattern indicates various circuit conditions. First of all, the patterns are not straight lines, and neither are they

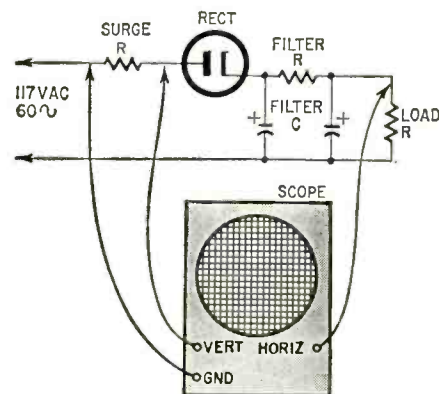

Fig. 5—Scope connected to check operation of a simple power supply.

circles. We do not expect to see a circle because we know that the current is not a sine wave. Also, we do not expect to see a straight line because the filter capacitors would have to be tremen-

dously large to have practically no reactance in the circuit.

Fig. 6-a is the normal waveform. It has a significant height, width and area. If the output filter capacitor has lost capacitance, its reactance increases and the ac voltage drop becomes greater. The pattern increases in width, and it encloses a larger area (Fig. 6-b). The line current is not changed appreciably, as shown by the pattern height.

Note the pattern in Fig. 6-c. The input filter capacitor is low in value. The voltage drop across the capacitor is increased. Or, we say that the ripple voltage is greater at the input of the filter—and this means that there will be a greater ripple voltage at the output of the filter. The scope shows more vertical and horizontal deflection, and a greater pattern area.

Wattmeter is no help

Here is an extremely important fact that the electronic technician must keep in mind: A wattmeter test in this circuit is completely misleading. In other words, a wattmeter does not read correctly unless the voltage and current are both sine waves. We know that the current is not a sine wave. Hence, we should never try to check such electronic circuits with wattmeters. A false read-

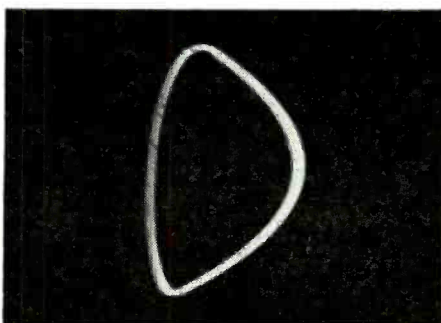
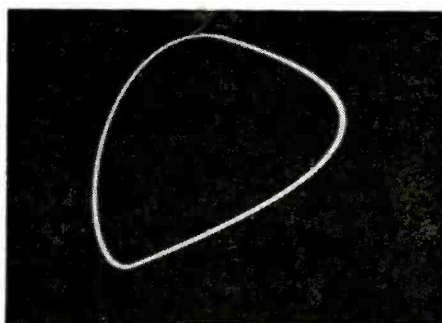
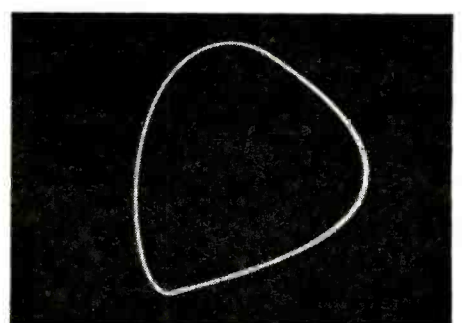

Fig 6-a—Pattern for normally operating circuit.



b—Pattern when output filter capacitor is low in value.



c—Pattern when input filter capacitor is low in value.

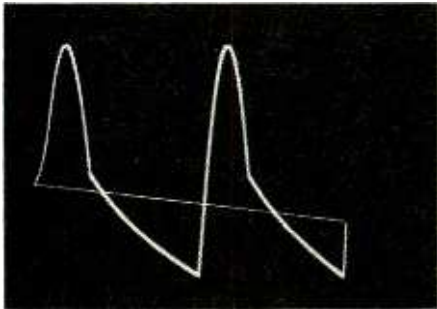
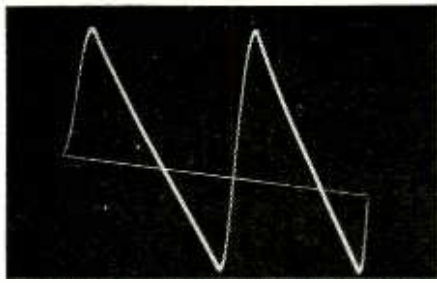

Fig. 7-a—Normal waveform across input filter capacitor. b—Distorted waveform is displayed when the input filter capacitor has low capacitance and a poor power factor.

ing is unavoidable.*

On the other hand, if we check a motor circuit or a lamp bank with a wattmeter, we read the real power in the circuit. The reading is correct because the load operates from a sine wave voltage and a sine wave current. Note that the wattmeter indicates only the real power in the circuit. An induction motor might be drawing considerable reactive as well as resistive current. The wattmeter shows only the resistive power. The wattmeter does not see the reactive power.

However, we can easily find the reactive power in such a motor circuit by supplementing the wattmeter reading with voltage and current measurements. Many service wattmeters also have current and voltage scales. Here is the basic principle: We measure the voltage and current in the circuit. For example, we might measure 100 volts and 1 ampere. Then, there are 100 volt-amperes in the circuit. Now, if the wattmeter reads 75 watts, 75 watts of real power are present. The 25 watts difference is reactive power (VARs—volt-amperes reactive), which merely surges in and out of the load, doing no real work.

Wattmeters must be used with great caution in electronic circuits. Whenever the voltage or current, or both has a nonsinusoidal waveshape, we cannot use wattmeters.* By the same token, we cannot use rms reading voltmeters and ammeters. This is why the scope is such a valuable tool in electronics work.

More waveforms

Now let us look at some other interesting waveforms found in a simple power supply. A simple test is made by

* A good electro-dynamometer instrument will read correctly on such waveforms. However, this type of wattmeter is seldom found in service shops.

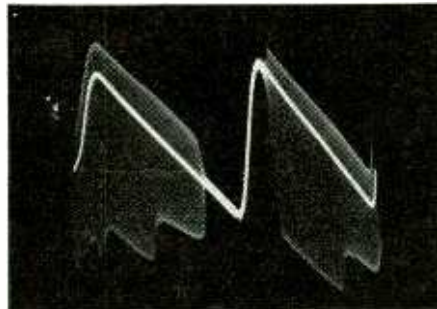
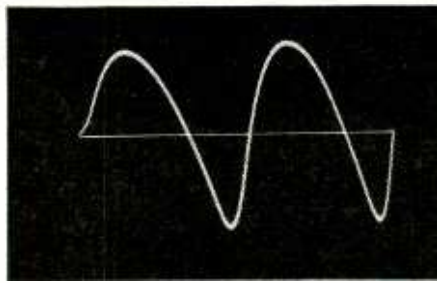

Fig. 8-a—Normal waveform across output filter capacitor in a radio receiver. b—Highly distorted waveform is displayed when the output filter capacitor has lost much of its capacitance and has a poor power factor.

connecting the scope's vertical input terminals across the input filter capacitor. We display the waveform in the ordinary manner using sawtooth sweep. Fig. 7-a shows the normal pattern compared with the distorted pattern (Fig. 7-b) displayed when the input filter capacitor is faulty (when it loses capacitance and develops internal resistance).

When a filter capacitor develops high

internal resistance, it has a poor power factor. We can measure the power factor with a capacitance bridge, which will also show any capacitance loss which may have taken place. In other words, we confirm the scope test by disconnecting the capacitor and checking it on a bridge.

Next, let us connect the vertical input terminals of the scope across the output filter capacitor. Fig. 8-a illustrates the normal waveform compared with the highly distorted waveform (Fig. 8-b) displayed when the output filter capacitor is very low in capacitance and has a very poor power factor (high internal resistance). In addition to the distorted waveform, we see a periodic high-frequency oscillation riding on the pattern.

Where does the spurious high-frequency oscillation come from? In this example, we do not have a simple resistive load connected to the filter output. Instead, the filter feeds supply voltage to an ac-dc radio. With a faulty filter capacitor, normal bypassing (decoupling) is not accomplished. Instead, the receiver circuits break into spurious oscillation.

The beginner may judge the scope a mysterious and complicated instrument. However, it is really quite simple. It is only necessary to become familiar with reading distorted waveforms, so that we know what they mean. The best way to do this is to start with simple breadboard circuits or ordinary radio receivers which are operating unsatisfactorily. A little practice with the scope will open new fields of electronic savvy. END

New Idea in Tape Recorders

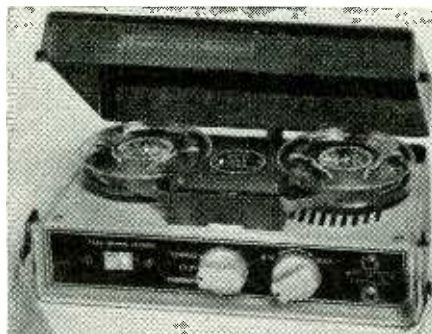

THE REMARKABLE THING ABOUT THIS miniature tape recorder-playback machine is that no tape speed is specified. The reason is simple—there is no fixed tape speed! The unit operates without a capstan, the tape is pulled by the takeup reel. When that reel is nearly empty, the speed may be down to about 2 ips. As it fills up, the speed increases to about 5 ips.

Since corresponding portions of the tape are played at the same speed (approximately) in recording and playback, this speed variation is not noticeable when tape is played back on the same machine. Although two machines were not available for testing, it would seem that tapes could be played back almost equally well by a similar machine; any individual variations would probably be too small to be easily detectable.

Used for voice, the little unit performs very satisfactory. No attempt was made to check it on music—it does not look to be designed as a hi-fi device.

The amplifier has four transistors (the last two in a push-pull output stage). The equipment operates off two size-C flashlight cells, one for the motor and one for the amplifier.

Several recorders of this type are being sold in the U. S. The one shown here carries the brand name Continental.

TV

Camera You Can Build

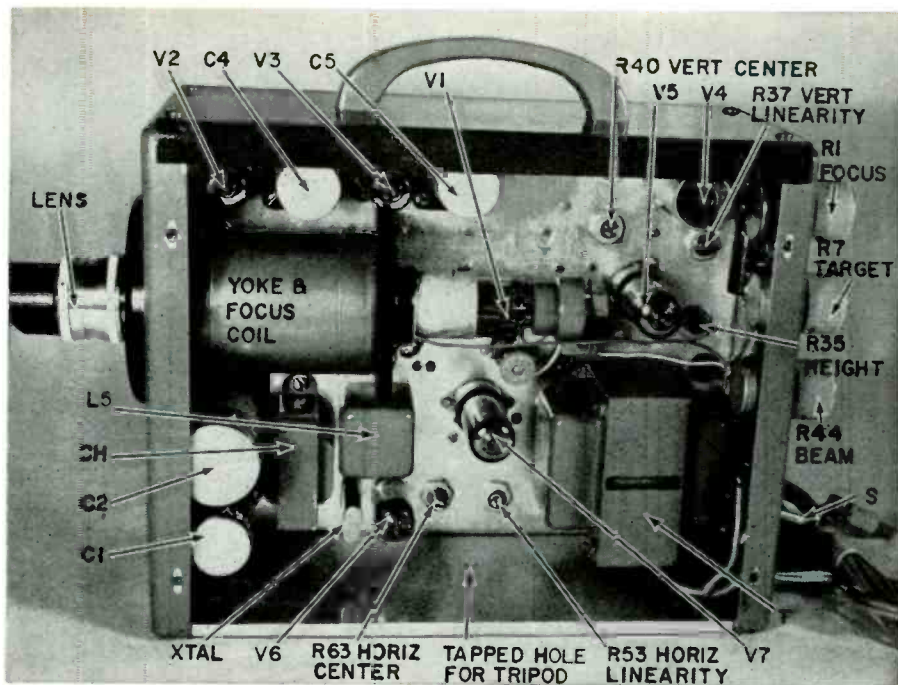

Six-tube instrument at far lower cost than commercial units

By W. E. PARKER

SIMPLIFIED CIRCUITRY AND COMMER-
cially available vidicon camera deflection
components now make it possible to
build your own closed-circuit TV
camera.

The single-unit self-contained TV
camera has the essentials of a miniature
television station. To form a complete
closed-circuit (wired) television system,
only the addition of a modern TV re-
ceiver is required.

The output signal of the camera is
tuned in on a TV set the same way as a
standard TV broadcast station is tuned.
A single cable connects the camera out-
put to the receiver antenna terminals.
No other connections to the TV set are
required. The modulated rf signal may
be received on channels 2 through 6,
depending on how the camera is ad-
justed. **NO ATTEMPT** at broadcasting
or other uses of the radio-frequency
waves for radiated transmissions may
be made without express permission
being obtained from the FCC.

Applications

There are many uses for the TV
camera presented in this article. They
are limited mostly by the user's imagi-
nation and the available light necessary
for a satisfactory picture. From ob-
serving junior in his crib to the sales-
man knocking at your front door, there
are limitless possibilities for your own
private television system.

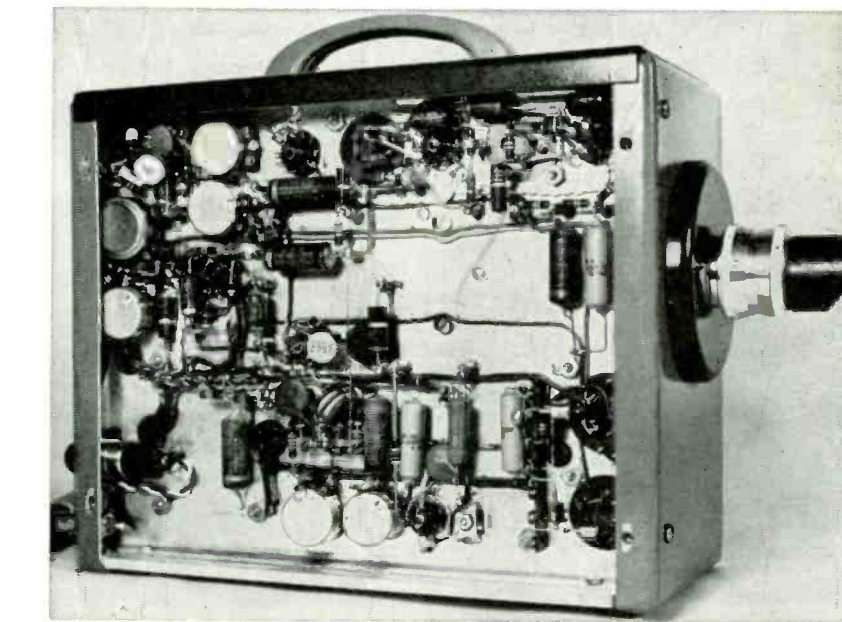

Careful wiring keeps the underchassis from getting confusing. Top photo shows the inside of the camera case as guide to the location of the larger components.

For the licensed amateur radio opera-
tor who contemplates the thrill of
amateur TV transmissions on the cur-
rently authorized 420- to 450-mc band,
this TV camera is ideal.

Now build it

The camera (Fig. 1) is housed in
an 8 x 10 x 4½-inch aluminum case that
is built around the chassis. The two end
sections are the same size and shape.
The bottom is a piece of 3/16-inch alu-
minum plate with a ¼-20 hole tapped

near the point of balance for tripod
mounting. The top section requires only
two right-angle folds. One of the side
panels has ventilation holes. The side
panel without openings covers the wir-
ing side of the chassis. No attempt was
made to miniaturize the camera. Sim-
plicity and accessibility are the keynotes
of its design.

While not critical, parts placement
must be considered. Weight distribution
and ventilation were also considered in
the parts layout. Locate the power

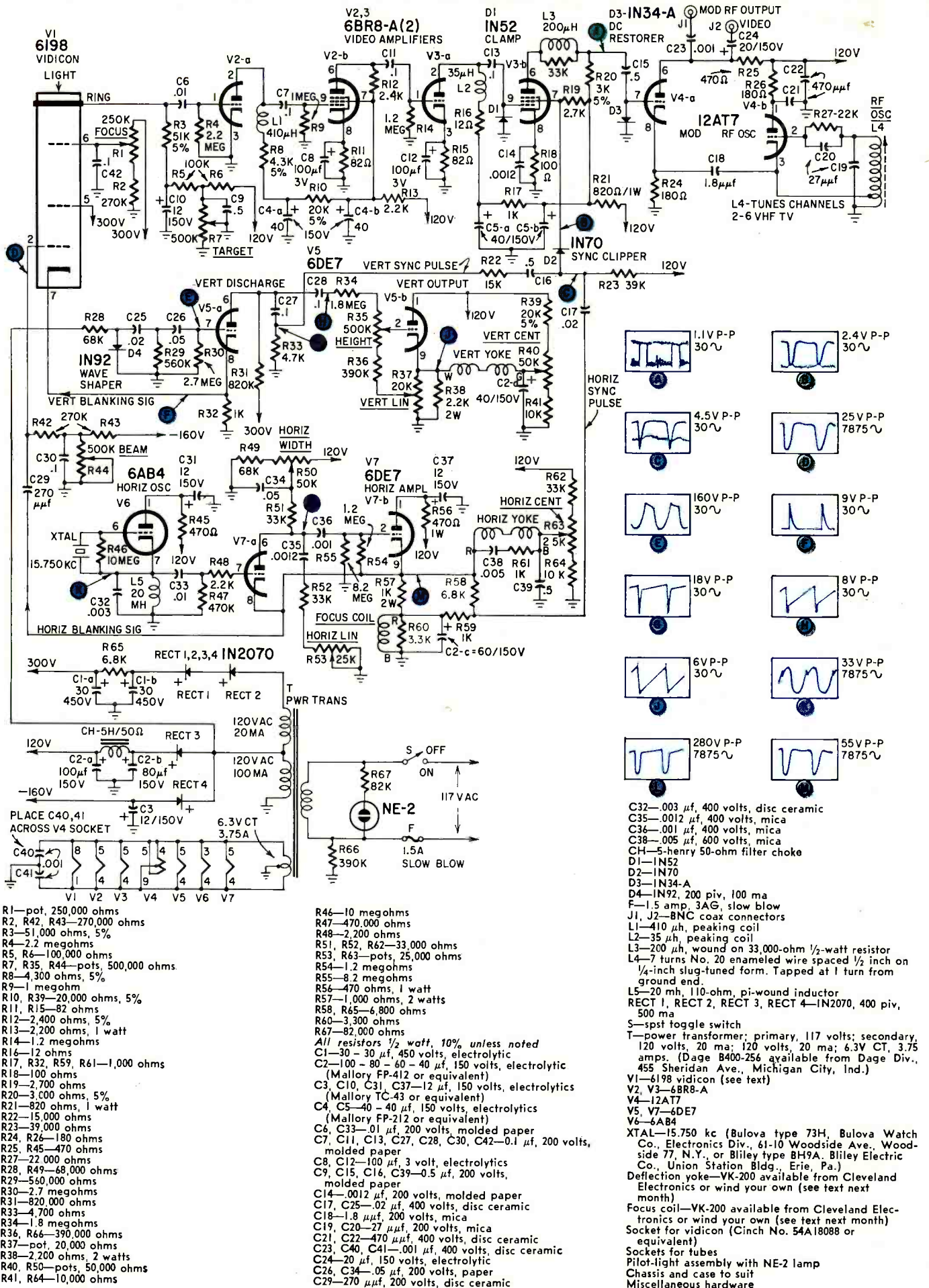

Fig. 1—Complete circuit of the home-built camera.

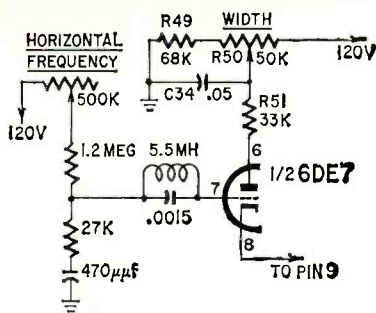

Fig. 2—L-C stabilized multivibrator eliminates crystal oscillator and reduces number of tubes to six.

transformer away from the deflection components. Arrange the first video amplifier as near as convenient to the signal ring of the vidicon. Keep the rf oscillator away from the first video amplifier or provide adequate shielding.

The BEAM, TARGET and FOCUS controls are adjusted frequently, and must be readily accessible. The remaining controls require less adjustment after initial setup. The horizontal sweep generator consists of V7-a and V7-b connected as a cathode-coupled multivibrator synchronized by V6, a 15, 750-cycle crystal oscillator. An alternate circuit with L-C stabilization is shown in Fig. 2. If the L-C stabilized horizontal oscillator is used, it may be wise to provide external adjustment for the HORIZONTAL FREQUENCY control.

Small insulated standoffs were used in place of terminal strips. The peaking coils are inexpensive standard replacement units.

Early adjustments

The vidicon is relatively delicate and must be handled with care. Be especially careful of the area around the exhaust tip (Fig. 3).

Many initial checks and adjustments can be made without the vidicon tube installed. This is a good idea as its photosensitive surface can be damaged

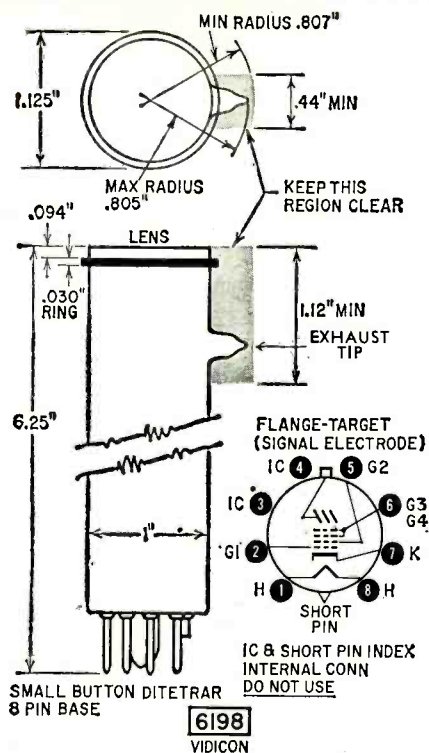

Fig. 3—Base diagram and outline drawing of the 6198.

by improper deflection or loss of deflection.

With all tubes except the vidicon installed, measure the three power supply voltages. Even if the camera is not adjusted properly, this will not affect the readings appreciably.

Adjusting L4 while watching a nearby TV receiver should produce some bars on the screen if the receiver is tuned on one of the lower-frequency unassigned channels. This shows that the rf oscillator is working and the modulator is modulating the rf carrier. The bars are caused by the vertical and horizontal sync information. If an at-

tempt to lock in the picture fails, the next step requires a general-purpose oscilloscope.

Waveforms

With the vidicon tube still removed, examine the vertical waveform on your scope screen. Do not proceed until waveforms almost identical to those shown in Fig. 1 are obtained. It is not absolutely necessary that the amplitude of the waveforms be exact at this point.

Check the horizontal waveforms next. They will differ from camera to camera to some extent. Do not install the vidicon until both the horizontal and vertical waveforms are reasonably correct.

When you have reasonably correct waveforms, a locked-in raster without video modulation should be obtainable. To check the video amplifiers place the tip of a screwdriver near the grid of V1-a and look at the locked-in raster on the TV set. Wavy lines or bars will be seen, indicating that the video amplifier is capable of amplifying.

Before installing the vidicon, check each socket pin for proper voltage and whether it can be varied by the associated control. Upon completion, install the vidicon tube, making certain that the signal electrode is connected and does not touch ground. Place the lens system in position.

Do not expect to see a picture right away! Expect to see blurred light and dark areas that move as the camera is positioned.

However, by adjusting the lens and the beam, target and focus controls an image should form. Adjust the linearity, height and width controls to improve the picture further. The positioning controls will aid in picture alignment. It may be necessary to rotate the yoke.

Lens systems

A lens with a focal length of approximately 1 inch (25 mm) will do nicely for general coverage. A lens with a speed of F:2.8 or better that has an adjustable iris will prove satisfactory. Movie camera 16-mm lenses are recommended, although some 8-mm lenses will do.

Miscellaneous

The deflection components are available from Cleveland Electronics Inc., 1974 E. 61 St., Cleveland 3, Ohio. The VK-200 coil kit is of the highest quality. The alignment coil was not used and need not be ordered. The scanning beam is aligned by passing a small amount of dc through each of the deflection coils (see R40 and R63). If you wish to wind your own coils, you will find all needed data next month.

Grade B and C vidicon tubes are available from Al Denson, P.O. Box 122, Rockville, Conn. (A grade-B tube has minor imperfections that are of little consequence to hobbyist, ham or home experimenter.) Vidicons other than the 6198 may be used.

Next month we'll also see just how each of the many camera circuits operate.

TO BE CONTINUED

Kerosene Generator Powers Radio

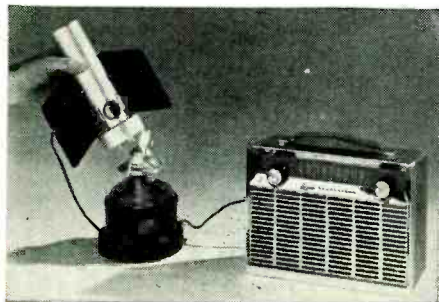

This Aztec thermoelectric generator will power a transistor radio for 24 hours on one pint of kerosene. It delivers 1/2 watt at 3/8 volt to a transistorized voltage converter built into the base of the lamp. This unit steps up the output to 6 volts dc at 175 mw. The lower

photo is a view looking straight down on the generator when it is in place over the lamp. Made by Minnesota Mining and Manufacturing Co., the Aztec generator is designed as an emergency power source for use in fallout shelters, farms, sportsmen's camps and other remote locations away from power lines.

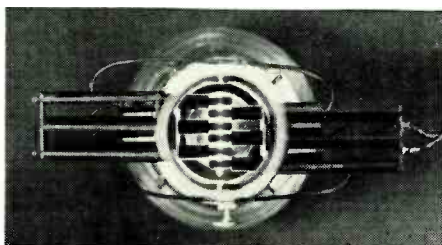

TUNNEL DIODE-TRANSISTOR MODULES operate at bit rates as high as 500 mc. They go together to form a computer system that can add four times as fast as conventional computers with only one-tenth of the circuit components. The G-E-built system is officially called a pumped tunnel diode-transistor logic system.

REAR WINDOWS IN RADAR CRT allow auxiliary displays to be projected onto the tube screen along with the actual radar image. For example, you might project a map or grid onto the face of the tube. Then the radar display would indicate exactly where the pip was located in relation to the area shown on the map. The tube was developed by General Atronics Corp.

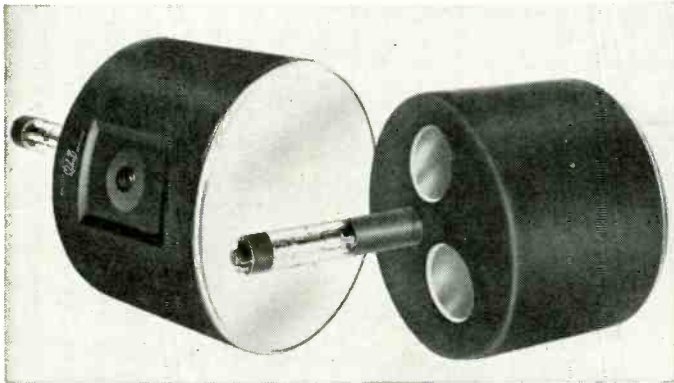
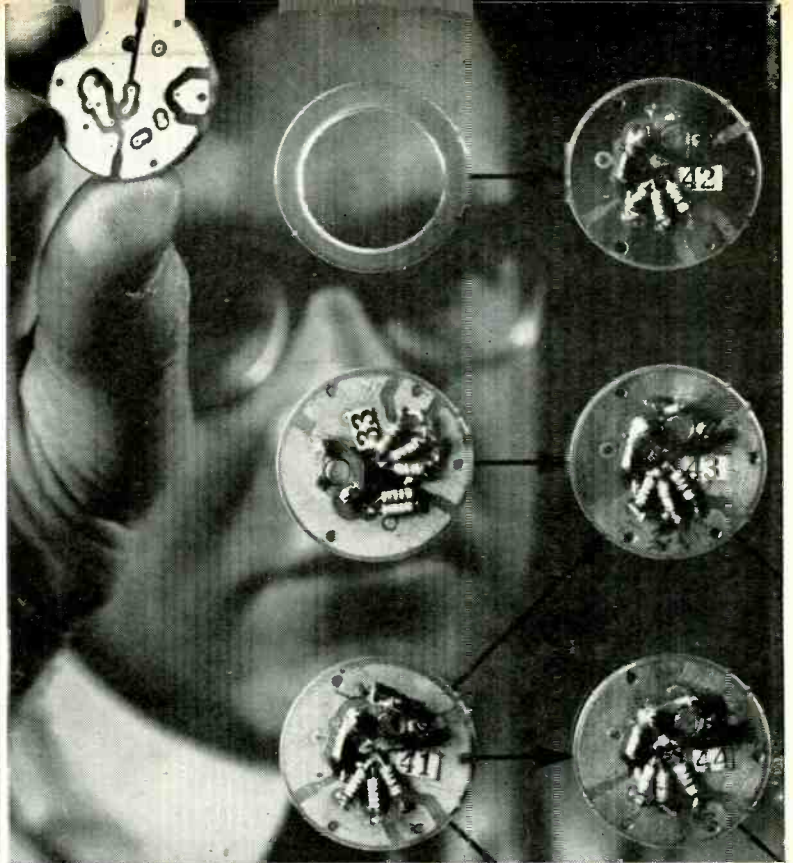

ULTRASONIC TRANSLATOR turns 35,000- to 45,000-cycle sound into audible frequencies. It's used to detect early stage friction in bearings, bushings and other machine parts. Here an engineer is checking for lubrication requirements on the tail rotor drive shaft of a helicopter with The Delcon Leak and Friction Detector.

What's New

BALL TRACKER centers the pip on radar screen. The single control adjusts two potentiometers simultaneously, speeding the process considerably. Turning the ball moves the pip both horizontally and vertically at the same time and the operator has only the one control to fuss with, rather than two interdependent controls. The device is made by Hughes Aircraft.

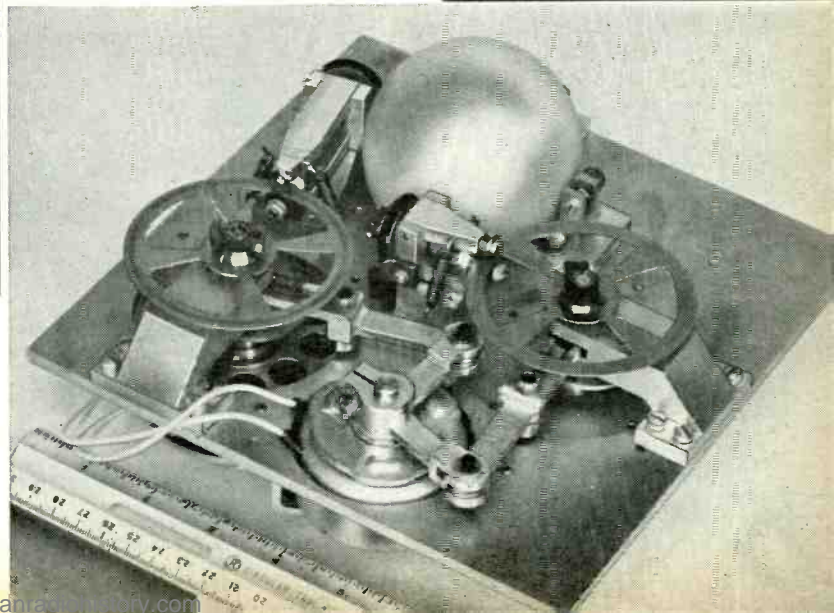
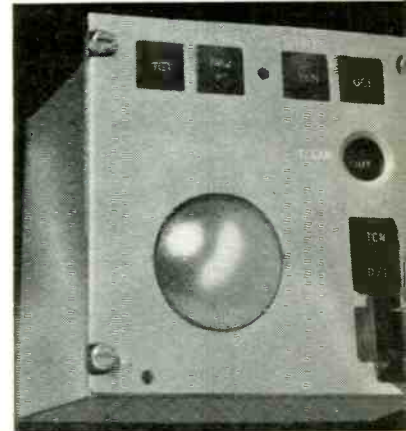

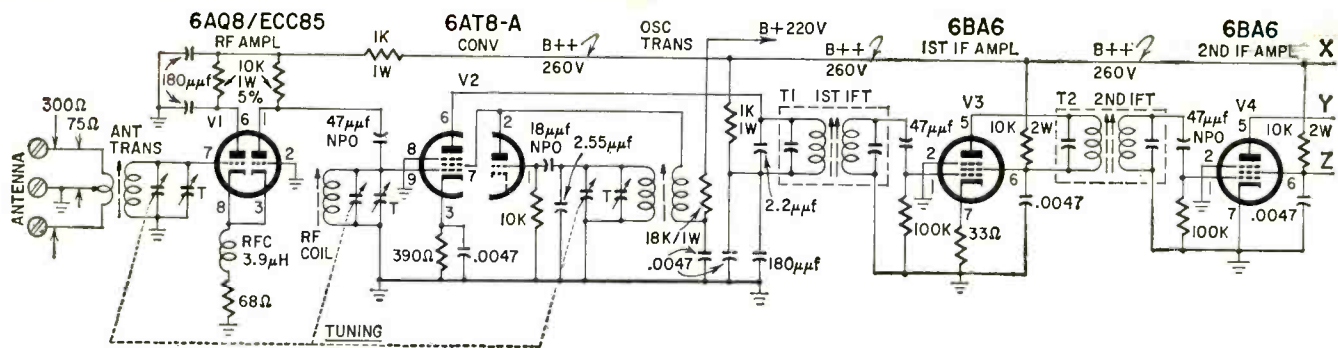

FM TUNER

By JOSEPH MARSHALL

The purchaser of an FM tuner kit looks for two things—the highest possible performance and the greatest immunity to trouble in assembling and adjusting it. Since these two ends conflict, the kit tuner designer is faced with no easy problem. The Dynatuner presents a most interesting and unconventional solution from a circuit standpoint.

The FM-1 Dynatuner bucks the current trend in front ends by using a cathode-coupled rf stage instead of the almost universal cascode or the new nuvistor neutrode. The noise figure of the cathode-coupled stage is inferior to a cascode arrangement with the same tube or an equivalent triode in the neutrode circuit. But it has some very significant advantages over the other two—particularly in a kit. It is much simpler and less critical than either the cascode or neutrode, requires no neutralization and fewer parts. Also it is less susceptible to cross-modulation and thus more nearly immune to spurious signals in local areas and easier to construct and align.

Despite its higher noise figure, the Dynatuner has a very respectable effective sensitivity. The manufacturer

specifies 4- μ v IHFM sensitivity, and individual tuners have measured sensitivities as good as 2.5 to 3 μ v. Very few run higher than the specified 4 μ v.

Circuit features

The converter is also unconventional, though not new. Oscillator voltage is injected into the screen of a pentode through a direct connection to the plate coil of the tuned-plate-tuned-grid oscillator. This gives a high degree of injection, which results in exceptionally uniform gain over the entire FM band. Moreover, it isolates the

local oscillator from the tuned circuit in the converter grid, resulting in almost complete freedom from "pulling." As a result, the tracking adjustment for the front end is uncritical, since converter-coil peaking has no effect on the oscillator frequency. Also, strong stations adjacent to weak ones do not "pull" the tuner away from the weak stations. The oscillator is carefully temperature-compensated and shows no significant frequency drift even in the very first few minutes of operation.

The four-stage if amplifier is arranged by proportioning the plate and bias voltages so that all four provide some amplification on weak signals and some degree of limiting on strong ones. The gain is so high that, with no signal input, the noise of the input tube alone is enough to produce some limiting. The tuner has an extremely steep limiting curve and suppresses noise completely on inputs as low as those needed for equivalent noise suppression with tuners of higher absolute sensitivity. Although a 3- or 4- μ v signal is needed for 30-db noise suppression, only 6 μ v is needed to produce a 40-db signal-to-noise ratio and about 10 μ v for 50-db noise suppression. Complete limiter saturation occurs with a signal of around 25 μ v and results in a 60-db noise ratio.

Tuner sensitivity is more effective because of the extremely wide bandpass of the if amplifier. It appears to be between 270 and 300 kc wide—as far as I am aware the widest bandpass in any tuner today. More remarkably, it is

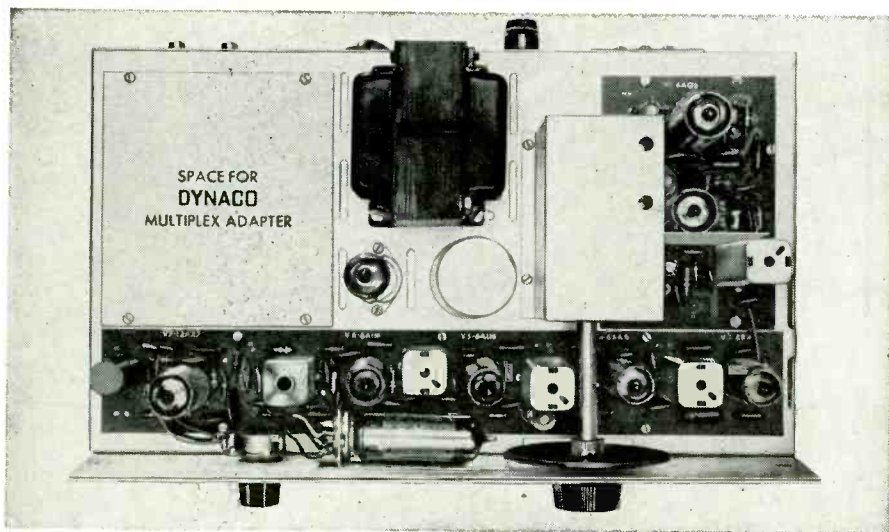

Top-chassis view of the Dynatuner.

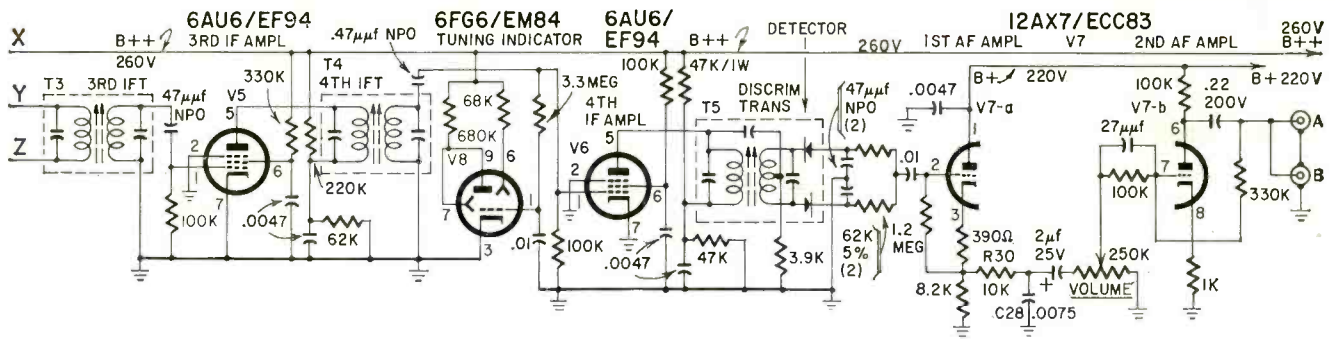

WITH A TWIST

It has an add-on power amplifier, a very unusual power supply and some circuitry that is rare in FM

done with undercoupled if transformers and thus produces a response curve with a single hump. This permits accurate alignment with very simple means. Thus even an overmodulated signal finds plenty of room to pass through the tuner without generating significant distortion. Signals above 5 or 6 μv have completely negligible distortion—0.5% or less. Even at the 30-db IHFM test point, distortion is only about 1% and constitutes only a third of the residual noise.

Since random noise is more tolerable than distortion, extremely weak stations, even those with poorer than 30-db noise ratio, are often more tolerable than with tuners of higher sensitivity but narrower bandpass. Such tuners provide greater noise suppression but produce higher distortion. In our tests we found that although a signal may be too far down in the noise to be intelligible, even the weakest signal is not too distorted to be intolerable.

The tolerance of overmodulation—unfortunately all too common—is almost phenomenal. With a signal generator you have to exceed 200% modulation before distortion becomes audibly annoying.

Despite the wide bandpass, skirt selectivity is good. The “alternate-channel” selectivity (400 kc from resonance) is better than 50 db. Hence, there should be no trouble with interference in local areas where stations are spaced at least 400 kc apart. It is quite possible to separate two stations 200 kc apart unless one of them is

many times stronger. Indeed, the 200-kc selectivity is considerably better than average because of the lack of oscillator pulling and the good capture ratio (6 db). The selectivity may be inadequate only in the case of a listener, for example, in New York who desires to hear a station in Philadelphia only 200 kc from a local station. (However, only two or three tuners, using six or seven if transformers, can give acceptable reception in such a situation.)

The detector

Although at first glance this looks

like a ratio detector, it is actually a balanced-bridge discriminator using a pair of matched crystal diodes. Because of the bridge configuration, it provides a high degree of AM and noise suppression, like a ratio detector. This is true because the AM and noise divides equally between the two legs of the bridge and are cancelled in the output, whereas the FM is always unequal in the two legs and the output represents the difference. The detector bandwidth is only moderately wide—about 600 kc—but, with the very stable local oscillator and the wide passband of the if amplifier, provides uncritical tuning. A very simple and foolproof method has been devised by the designers for aligning the detector, using the tuner's own electron-ray indicator.

For years I have considered the counter the best of the FM detectors. On direct comparison, I find that the Dyna balanced-bridge is closely equal in terms of low distortion, and superior in AM and noise rejection. The counter permits the noise of the final limiter to come through; the Dyna suppresses this final noise component effectively. The Dyna detector is superior to the ratio detector in distortion

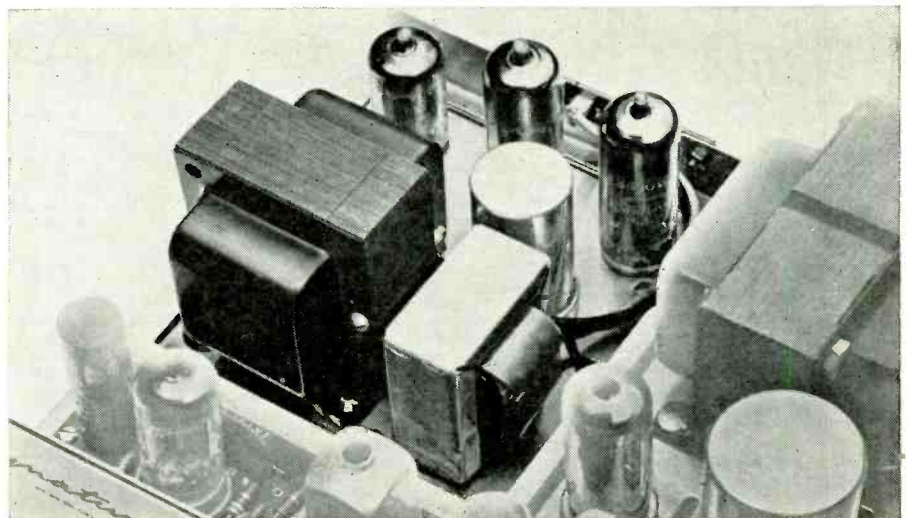

Power amplifier (unfogged portion of the photograph) is tucked away in space allotted for FM stereo adapter.

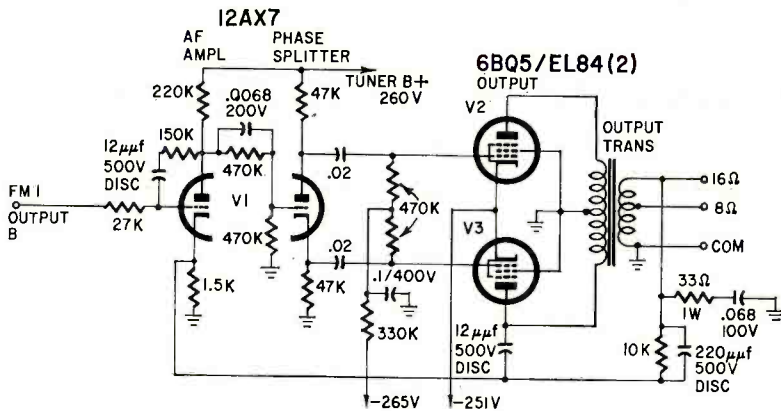

Fig. 1—You'll note that in this power amplifier the screens and plates of the output tubes are grounded.

and nearly equal in noise suppression. It is superior to other discriminators both in lower distortion and noise suppression. The use of solid-state diodes furthers the maintenance of an extremely low noise level, not only because of the inherently lower noise level of crystals over electron tubes, but also because with no heaters no hum is injected at this point. The detector's performance is further aided by its coupling to the audio stage through the high impedance of a cathode follower. This prevents loading the detector by the de-emphasis network (R30-C28).

The audio amplifier has more than 20 db of feedback. In fact, the stage gain is only 10 db. The response curve is unusually wide, running well within 1 db from below 20 to above 50,000 cycles. Overall distortion is well below 1/2% from 20 to above 20,000 cycles for any signal exceeding 10 μv.

As this is being written the Dynatuner MX adapter is not yet available. However, the design of the tuner forecasts exceptionally good stereo FM performance, assuming a multiplex circuit as good as that of the tuner. The very wide passband, the outstanding ability to receive weak signals with low distortion, and the flat audio response are all highly favorable for multiplex reception.

Meanwhile the manufacturer does offer a very compact 10-watt amplifier (model FMA-2) which will fit the space left for the stereo adapter and thus provide a complete FM receiver. This amplifier is also notable for the unconventional but clever way it uses the very small power transformer of the tuner to power both the tuner and the amplifier.

Built-in power amplifier

If one of these tuners is brought into your shop with the power amplifier, you may well jump to the conclusion that the chap made a terrible boner in wiring. Actually the wiring is correct (Fig. 1), and the amplifier operates with conventional voltage parameters. If you measure the voltages from cathode to plates and grids, you will find that the plates are about 250 volts positive and the grids around 14 volts negative, as they should be. And, while it is true that the power supply delivers

around 70 ma to the output tubes and another 70 ma to the tubes in the tuner, the transformer is operating only some 5% above its dissipation rating, which is well within its tolerance. How is it possible to steal 70 ma from a power supply with a 100-ma rating without overheating the transformer?

Fig. 2 is a simplified diagram showing the power supply as it looks when the amplifier is added. A pair of diodes is connected across the transformer with the cathodes on the transformer side to rectify the negative half-cycle. The normal "full-wave" rectifier makes only partial use of the negative half cycle. By using it with another pair of rectifiers to feed a second load, we do increase the total load on the transformer. This is partly offset by the fact that operation is 30% more efficient in this mode. If we put a load on the negative supply equal to the load on the positive one, we increase the dissipation of the transformer only 50% instead of the 100% you would expect. Since the Dynatuner transformer was operating with a 60% factor, the addition of the 70-ma load of the amplifier merely brings the dissipation up to the rated dissipation of the transformer or perhaps 5% more. In any event, the transformer heats little or no more than it would if it were drawing the full 100 mils of current with a single full-wave rectifier.

Some adjustments have to be

made to make this thieving power supply work well. The filaments of the EL84's must be fed by a separate transformer. Otherwise the heater-to-cathode potential would be around 250 volts, considerably above the permissible potential difference. The two halves of the power supply should be as closely balanced in load as possible. In this instance, the 12AX7 of the amplifier is fed by the tuner power supply, thus adding just enough drain to balance the two sides.

The amplifier circuit itself is only slightly modified from the standard Dyna configuration. The output transformer is smaller and not as linear as the bigger Dyna transformers. It will deliver 10 watts with less than 2% distortion from 30 to 15,000 cycles. Below 30 cycles and above 15 kc, the power output slopes and distortion is higher. The voltage amplifier is direct-coupled to the phase splitter through a voltage divider which is compensated with a capacitor to provide a step at the low-frequency end to make up for the slope of the output transformer and thus maintain stability at the low end. There is an inner feedback loop from the plate of the lower output tube to the input cathode to provide a step at the high end and to compensate for the frequency unbalance at the high end of the splitter. Also, there is a feedback loop around the input stage.

Although extremely compact and inexpensive, the amplifier delivers excellent performance. It was demonstrated at the Chicago and New York shows driving an AR-2 speaker to perfectly satisfactory levels even under the rather high noise levels that exist at shows. In no sense a substitute for a bigger amplifier, it does offer an economical and simple means of obtaining FM reception where space and cost are the main considerations. It is also ideal for use as a supplement to a big high-fidelity system for use in the bedroom, kitchen, porch or summer cottage.

Miscellaneous notes

The Dynatuner is available in three forms—the normal kit, a partially assembled kit and fully assembled. In the normal kit, the constructor mounts

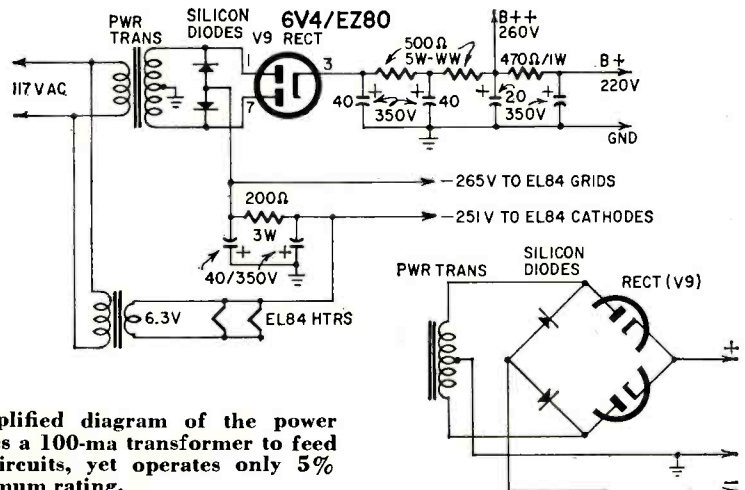

Fig. 2—Simplified diagram of the power supply. It uses a 100-ma transformer to feed two 70-ma circuits, yet operates only 5% over its maximum rating.

all the components on the two printed-circuit boards as well as on the chassis. This is not difficult and does not take much time but, as in the case of any P-C board, it does require great care in soldering each P-C joint to insure a firm contact and to avoid cold joints which may cause troubles. The semi-assembled kit comes with the P-C boards already assembled and soldered, and in this form it is possibly the simplest of all FM tuner kits to put together.

Aligning the Dynatuner offers no serious problems and can be done without any instruments whatever by using FM stations as signal sources and the tuner's own electron-ray tube as the indicator. The single-hump response of the if amplifier makes optimum peaking simple. The detector is aligned by a temporary reconnection of the tuning indicator. Optimum alignment and tracking of the front-end may be a little trickier for those who have never aligned a superhet but, if the instructions are followed carefully, it is possible to obtain very uniform sensitivity over the entire FM band since the design provides both capacitive and inductive adjustment of all three rf circuits.

Most simplified methods of aligning FM tuners without a meter of some sort produce results inferior to those with instruments in a laboratory. Much to my surprise, the Dynatuner can provide fully as good performance when aligned by the recommended method as is possible with instrument alignment. I found that a signal generator and vtm, or a sweep generator and a scope, or even an FM generator and a distortion meter gave little improvement.

As I have already indicated, the level of performance is very high. The sample we used had a measured sensitivity of $3.8 \mu\text{v}$ with a 300-ohm input. I found this adequate to receive every FM station receivable with high-fidelity quality with *any* tuner. Two or three other tuners with sensitivities of $2 \mu\text{v}$ or better made it possible to log a few more extremely weak stations 250 or more miles away. But these stations cannot provide high-fidelity listening with any tuner for any period longer than a few minutes. It appears that at the edge of the ground-wave range any station weaker than about $5 \mu\text{v}$ will fade into the antenna and cosmic noise too great a proportion of the time to afford reliable high-fidelity listening.

The nearest station we listen to is 40 air-line miles away and the majority are 150 or more. For example, during a 6-month period, with a Hy-Gain Log Periodic FM antenna, every FM station in Atlanta (150 air-line miles) including WABE, an educational station with only 3 kw of radiated power, was received with 100% reliability or close to it and completely high-fidelity quality. Every station within 250 miles could be logged and would provide sporadic periods of acceptable reception. No tuner we have used has done better from a high-fidelity point of view, and only two or three have permitted the logging of more stations. **END**

replacing Japanese transistor radio batteries

JAPANESE RADIOS USUALLY COME WITH JAPANESE BATTERIES. When these wear out and have to be replaced there is often some confusion on what US replacement to use. Perhaps this little list will help.—Warren Roy

	Japan	Eveready	Burgess	Ray-O-Vac	RCA
1.5-volt D-cell	UM-1	950, D-99, 100	210, 2, 230	3LP, 2LP	VS036
1.5-volt C-cell	UM-2	953, 635	1, 130	1LP	VS035A
1.5-volt AA cell	UM-3	915, 1015	Z, 930	7R	VS034A
1.5-volt AAA cell	UM-4	912	7	400	VS074
1.5-volt N cell	UM-5	904	N	716	VS073
9-volt	006P	216	2U6	—	VS312
9-volt	W06P	E177	YL6	—	VS309A
9-volt†	006	226	P6M, P6	—	VS322, VS300A

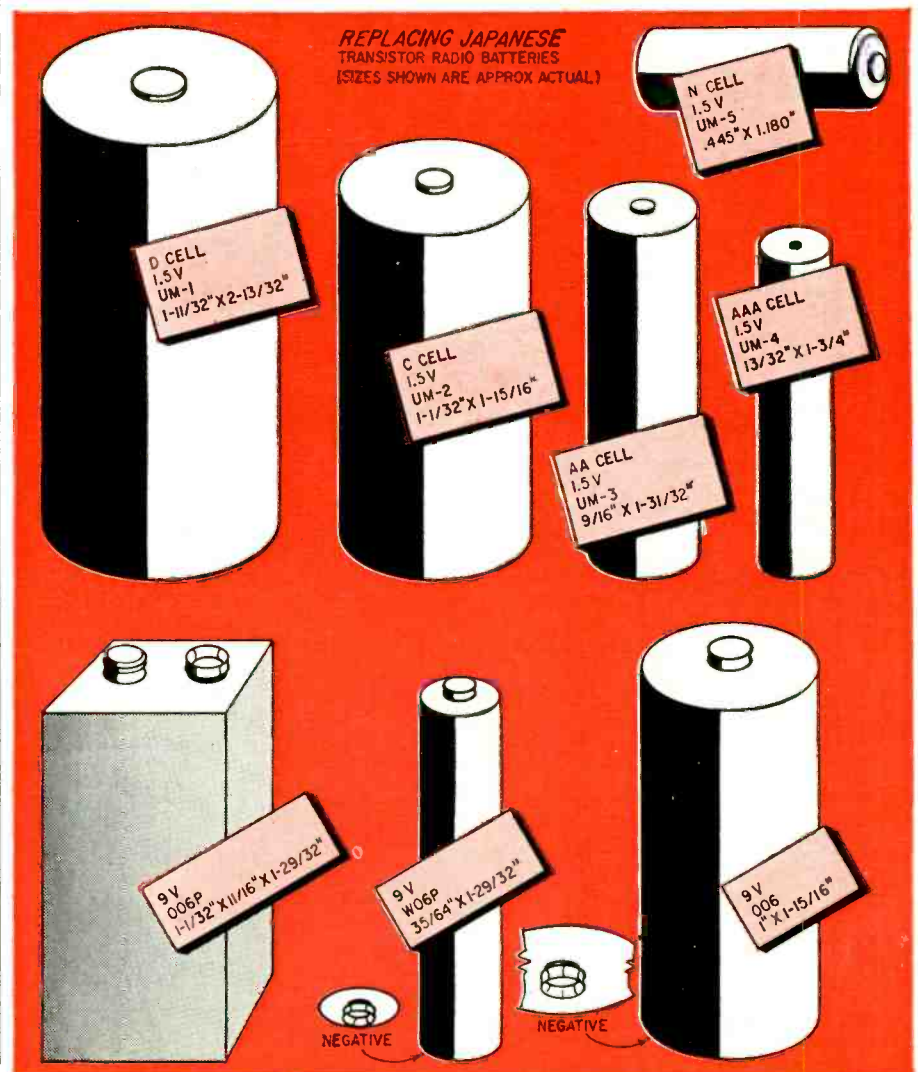

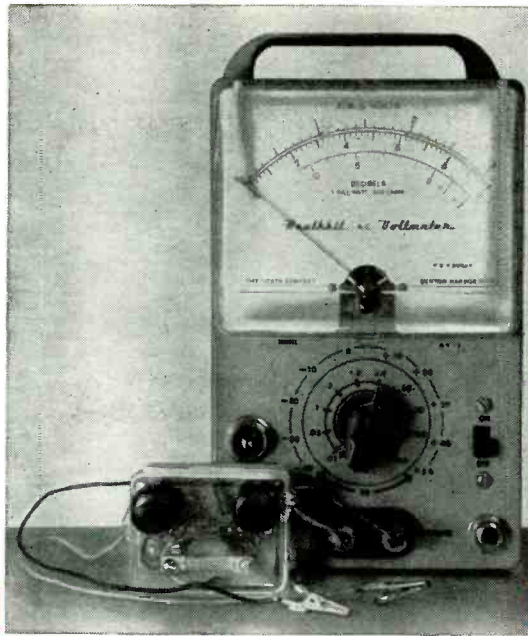

Converter and the vtvm it is used with.

Measure dc millivolts with a dc-to-ac converter

By FORREST H. FRANTZ, SR.

Simple, low-cost unit adapts ac vtvm for low-level dc voltage measurements

THE problem of measuring small dc voltages rapidly and accurately has challenged the electronics industry for years. Many practical measurement techniques and instruments have been developed, but most of them have been beyond the practical reach of the experimenter, hobbyist and service technician. Most dc millivolt measuring instruments cost hundreds of dollars.

Another difficulty has been zero drift—a problem encountered when vacuum tubes or transistors are employed as direct-current amplifiers in the instrument. And even the comparatively

simple potentiometer type of dc measuring instrument, although it is extremely accurate, is objectionable because of the time-consuming nulling procedure.

The most satisfactory approaches to the problem of dc millivoltage measurements have usually involved a dc-to-ac converter. The ac output of the conversion unit is proportional to the dc input in this scheme, and can readily be measured with an inexpensive audio voltmeter such as the Heathkit AV-2 or AV-3 or with an audio amplifier

1). The multimeter is set to a low ac volts range and connected to the amplifier's output. The converter feeds the amplifier's input. With the amplifier's gain set fairly high, use the amplifier's gain control and the converter's scale-factor control adjusted so the multimeter reading corresponds to the dc input.

The dc-to-ac converter described in this article is intended to be used in this way. Its cost is less than \$10. Extremely compact—only 1½ x 2½ x 1 inch—it can be assembled in about 2 hours. Power is obtained from a

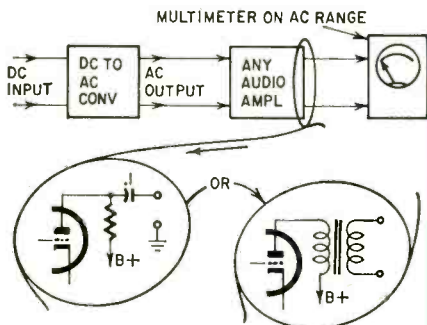

Fig. 1—Dc-to-ac converter can be used with any audio amplifier to measure dc millivolts. Just use this hookup.

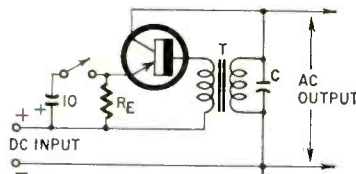

Fig. 2—Basic circuit of dc-to-ac converter.

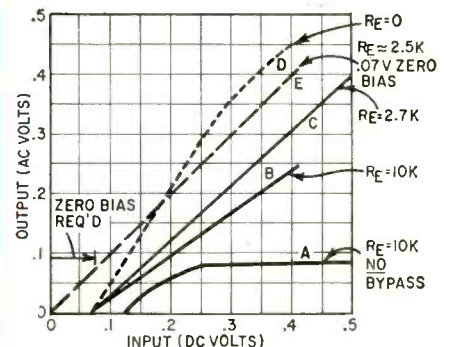
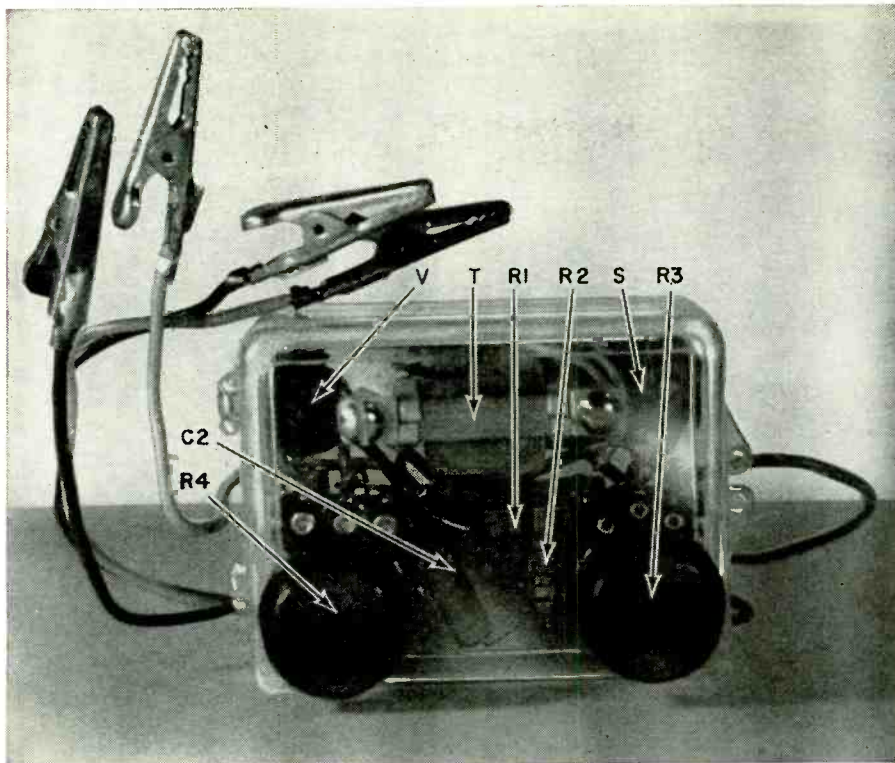

Fig. 3—Converter ac output vs dc input for various values of R_E , and bypass and bias conditions.



The entire unit fits into a small plastic case.

single self-contained inexpensive pen-light cell. Battery current drain is approximately 1 ma.

How it works

The basic circuit of the audio oscillator used in the dc-to-ac converter is shown in Fig. 2. Note that the dc voltage to be measured furnishes the dc operating voltage for the audio oscillator. The desired response is an oscillator audio output voltage directly proportional to the dc voltage supplied at the input. On a graph of ac output voltage against dc input voltage, this would be a straight line.

Curve A of Fig. 3 shows that, if the emitter bias R_E is unbypassed, the audio output is not a linear function of the input, and above 0.25 volt dc input, the audio output voltage is constant. This characteristic would be highly desirable where a constant output signal is desired regardless of battery-voltage variations. But it is

unsuitable for a dc-to-ac converter. Also note that oscillation does not begin till the applied dc voltage is 0.12 volt or more.

If the emitter resistor is bypassed with a 10- μ f capacitor, the response is linear as shown by curve B. If R_E is decreased, the slope of the curve gets steeper as shown by curves C and D. Furthermore, oscillations begin when the applied dc voltage is only .07 volt.

Although the desired linear response has been achieved and oscillations do begin at .07 volt, the arrangement can be useful only if oscillation begins just above zero volts. This can be done by inserting a .07-volt dc bias in series with the dc input voltage. This shifts curves B, C and D in Fig. 3 to the left so they can pass through zero.

The circuit for the practical converter is shown in Fig. 4. The variable-emitter resistor R4 is the scale adjustment which varies the slope of the response curve. The battery and resis-

tors R1, R2 and R3 provide the bias voltage for zeroing the converter. The resistance of the voltage divider is small in comparison to the converter's input resistance. The zero bias required may vary slightly from one converter to another due to transistor and component tolerances. Potentiometer R3 adjusts the bias for these and for battery aging.

R3 and R4 are adjusted when the instrument is calibrated initially and must not be readjusted each time it is used. R4 should be checked and, if necessary, readjusted about every 6 months to compensate for battery aging.

Construction and calibration

Building the unit is comparatively simple. Make the holes for the potentiometers, transformer, on-off switch, input leads and output leads first. A heated ice pick and a taper reamer will do the job nicely and minimize the risk of cracking the plastic case. Mount the potentiometers and output transformers next. A small piece of perforated board forms the chassis. After all connections are made and the unit is checked for operation, cement the perforated board to the potentiometers.

To calibrate the converter, adjust R4 to about 2,500 ohms, and connect the output terminals of the converter to the audio vtvm. Set the audio vtvm to the .01-volt range and short the input terminals of the converter. Adjust R3 till oscillation begins (evidenced by an up-scale reading on the audio vtvm). Then back off R3 to the point where oscillation just ceases.

Next, connect the converter terminals to a 0.3-volt dc source with the audio vtvm set on its 0.3-volt range. This voltage may be obtained from the circuit shown in Fig. 5. Adjust R4 for full-scale meter deflection. Disconnect the converter terminals from the voltage source and short them again. Repeat the R3 adjustment, since the change in R4 may alter the oscillator zero bias slightly.

Curve E in Fig. 3 shows the response of the completed instrument. The dc-to-ac ratio is 1 to 1. The calibration is as good as the accuracy of your calibrating voltage and the care you put into making the calibration. The range of the converter is 0 to 0.3 volt, which you can cover in four ranges—.01, .03, 0.1 and 0.3 volt—with the range switch of an audio vtvm. Since voltages above 0.3 can readily be measured with a conventional general-purpose vtvm, no provisions were made for using the converter to measure higher voltages.

- R1—100 ohms, 1/2 watt
- R2—1,000 ohms, 1/2 watt
- R3—pot, 1,000 ohms, miniature (Lafayette VC-26 or equivalent)
- R4—pot, 10,000 ohms, miniature (Lafayette VC-34 or equivalent)
- BATT—1.5 volts, N cell
- C1—30 μ f, 6 volts, electrolytic, miniature (Lafayette CF-104 or equivalent)
- C2—.01 μ f (Aerovox 83Z or equivalent)

- P1, P2—plugs to match vtvm input jacks
- S—spsst slide switch
- T—miniature transformer: primary, 2,000 ohms, ct; secondary, 10,000 ohms (Argonne AR-109 or equivalent)
- V—2N107
- Case—1 1/8 x 2 1/8 x 1 inch
- Perforated phenolic chassis—2 x 1 inch
- Miscellaneous hardware

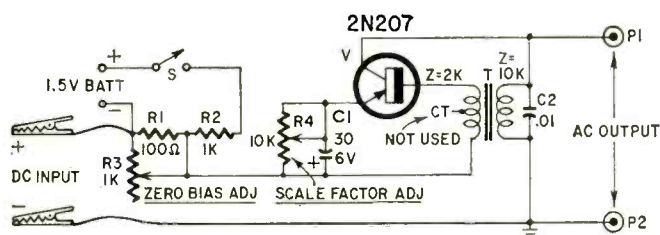

Fig. 4—Circuit of dc-to-ac converter.

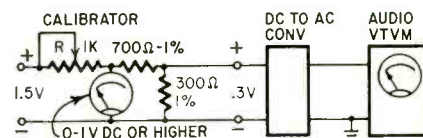

Fig. 5—Calibration circuit. Adjust R until dc voltmeter reads 1 volt.

Making Twisted Cable

By ELMER CARLSON

LENGTHS OF TWISTED PAIRS OF WIRES for filament and power circuits can be easily made with a hook bent from 3/16-inch OD tubing or rod. It may be necessary to heat some rod or tubing while bending it.

If both wires are the same color, simply unroll a little more than twice the required length and, with the loose ends held together, tie an overhand knot. With the knot end held in the hook, loop the doubled end over some solid, stationary object (a doorknob or tightened vise handle will do), and start winding with the drill (Fig. 1). For extremely long lengths, use an electric drill.

Fabric-covered wire needs a different

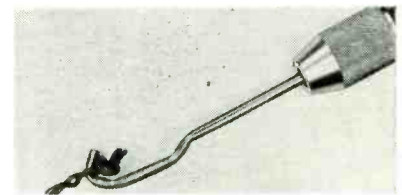

technique. It is necessary to provide some means for the individual wires to twist at the far end while winding. This requires a special jig consisting of two parts and for best results, an assistant.

Each wire is tied separately to an eyebolt mounted on a plate. The ring is on one side, a flat washer and two nuts on the other (Fig. 2).

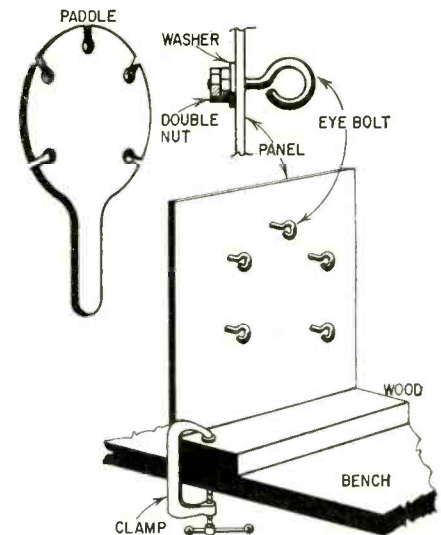

When three or more wires are twisted, a separator must be used to steady the wires. This keeps them from whipping, and maintains their spacing for a smooth, even twist.

A discarded ping-pong paddle can be used. It is evenly notched around the edge with keyhole-shape slots to guide the wires. As twisting progresses, the assistant moves away from the twisting end, keeping the wires separated. END

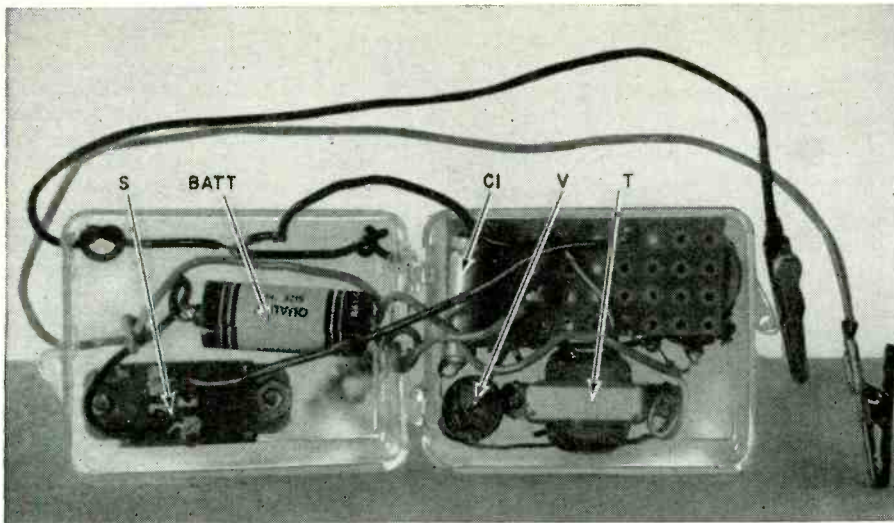

Parts are arranged in both halves of the case.

The converter will draw approximately 8 μ a from the dc circuit it measures for a 0.3-volt input and approximately 3 μ a for a .03-volt input. Circuit loading is quite small, and accurate measurements may be anticipated for circuits of moderately high impedance. If a dc-to-ac conversion ratio of less than 1 to 1 is employed by increasing the value of R4, input current requirements can be reduced even further. Since the 1-to-1 conversion ratio allows direct reading from

the ac vtvm meter scale and range switch, it was considered more advantageous than an arrangement which would introduce a conversion constant that had to be remembered and applied to meter readings. This way we get an easy-to-use direct-reading instrument.

The emitter resistor R4 stabilizes the circuit against drifts due to temperature changes. Any user of this circuit will be well pleased with its stability, linearity and overall performance. END

WHAT'S YOUR EQ?

It's stumper time again. Here are three little beauties that will give you a run for the money. They may look simple, but double-check your answers before you say you've solved them. For those that get stuck, or think that it just can't be done, see the answers next month. If you've got an interesting or unusual answer send it to us. We are getting so many letters we can't answer individual

ones, but we'll print the more interesting solutions (the ones the original authors never thought of). Also, we're in the market for puzzlers and will pay \$10 and up for each one accepted. Write to EQ Editor, Radio-Electronics, 154 West 14th St., New York, N. Y.

For answers to last month's puzzle see page 68.

Variable-Current Black Box

This particular Black Box has two terminals. When 50 volts dc is applied, 2 amperes flows. If 100 volts at 60 cycles is the supply source, the current is 12 amperes and the power 1,200 watts. With 151 volts at 400 cycles, the current is 10 amperes.

Draw the circuit and give the values of the components in the Black Box.—Frank A. Lopez

figure out. Here is one that can be done without calculation. Observe the circuit pattern and determine the voltage across the 1-ohm resistor.—Albert C. W. Saunders

Iterative Network

Engineers will recognize this problem as the very simplest type of iterative network, but it will be inter-

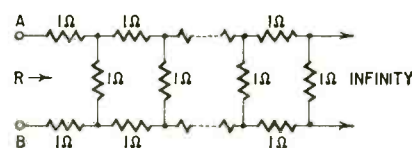

esting and useful to beginners. Good training for transmission lines, too!

The circuit shown above consists of 1-ohm resistors. The lattice extends to infinity. What is the total resistance of R, looking into points A and B?—Mordehai Arditti.

An Easy One?

Some readers have complained that many of the problems require calculus—or at least quadratics—to

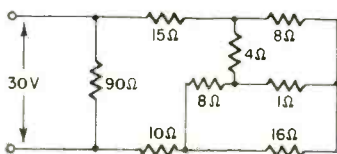

FREE!

WORLD'S BIGGEST KIT CATALOG!

SEND FOR YOUR COPY TODAY!

You'll find hundreds of low-cost, easy-to-build Heathkit products in this value-filled catalog . . . the world's largest and most complete! Over 250 different Money Saving kits are shown with complete descriptions, schematics, big photographs and full specifications. Send for your copy today! Save up to 50% of the cost of comparable products by doing the easy assembly yourself! All kits are fully guaranteed and available on no money down terms! Use the handy coupon below.



DELUXE FM STEREO TUNER: Brilliantly engineered. AM, FM and built-in FM Stereo Multiplex. Indicator light signals when FM stereo is being broadcast! Adjustable AFC and FM squelch; tuning meters, circuit boards.
Kit AJ-41...no money down \$11 mo. **\$119.95**
Assembled AJW-41, \$18 mo. **\$189.95**

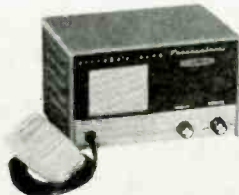

CB TRANSCEIVER: Low-cost, two-way radio! Crystal controlled superhet receiver and transmitter; squelch and automatic noise limiter; Push-to-Talk microphone; built-in AC power supply; provision for plug-in DC supply.
Kit GW-12A (AC only) 8 lbs. \$5 mo. **\$39.95**
Kit GW-t2D (AC & DC) 11 lbs \$5 mo. **\$44.95**



MARINE RADIO TELEPHONE: Factory wired and tested! 50-watt transmitter. 5 crystal-controlled transmit and receive channels. Covers 2-3 mc marine and standard broadcast bands. Built in vibrator power supply. An outstanding value! 25 lbs.
Assembled MWW-11A, no money down, \$24 mo. **\$259.95**



TUBE CHECKER KIT: Latest design. Tests all tubes including Compactron, Nu-vistor, Novar and 10-pin miniatures! Built-in roll chart. Individual tube element switches. Perfect for service. 11 lbs.
Kit IT-21...no money down, \$5 mo. **\$44.95**

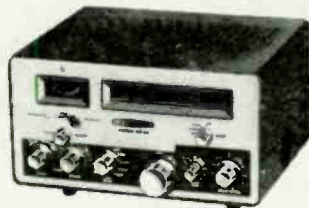

SSB MOBILE AMATEUR TRANSMITTER: 90 watt input, 80 through 10 meters, crystal bandpass filter, dual conversion heterodyne circuitry, automatic level control, switch selection of USB, LSB and CW, VOX or PTT operation. 19 lbs.
Kit HX-20, No money down, \$19 mo. **\$199.95**

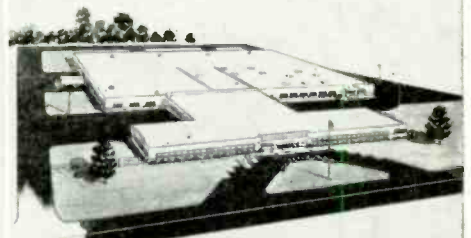

HEATHKIT
by Daystrom

World's oldest and largest manufacturer of do-it-yourself electronic kits



HEATH COMPANY
BENTON HARBOR, MICHIGAN

All prices and specifications subject to change without notice.

HEATH COMPANY
Benton Harbor 20, Michigan

Please send my free copy of the 100 page 1962 Heathkit Catalog

Name _____

Address _____

City _____ Zone _____ State _____

SERVICE CLINIC

Conducted by
JACK DARR
SERVICE EDITOR

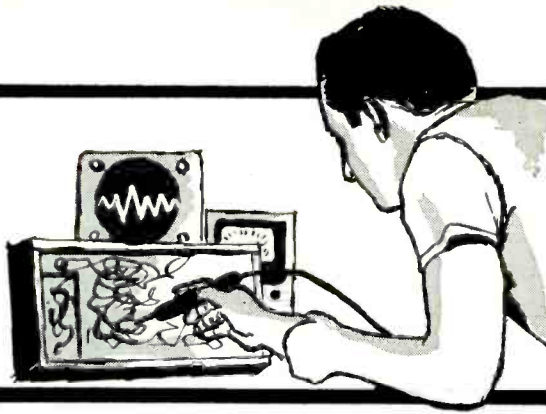

This column is for your service questions. We answer them free of charge and your name and address will be kept confidential if you wish. The main purpose is to help those working in electronics with their problems.

We've changed our target a little and are no longer restricted to TV. Radio, audio and industrial electronics problems are also grist for the mill. All letters get a prompt individual answer and the more interesting ones will be printed here. So if you have a service problem, send it here. We'll do our very best to help you solve it.

VERY SELDOM DO TROUBLES OCCUR IN TV transmitters or control equipment. However, no experienced engineer would deny that they *do* happen now and then. If the TV technician can recognize them, he may save a lot of time spent tearing down innocent TV receivers.

One of these troubles is occasional overmodulation of the transmitter. This results in an almost complete "white-out" of the screen (Fig. 1). It is caused by overmodulating the video carrier transmitter, thus *reducing* the amount of signal being radiated. Fig. 2 shows the difference between 100% and 120% modulation, which is about the level equivalent to the effect shown in Fig. 1. Note that actually *less* rf is being radiated during the overmodulated periods.

With our TV sets designed as they are, the stronger a signal is, the blacker our pictures are. In other words, our TV receivers start with a white screen. The signal extinguishes the beam of the picture tube by cutting it off. So if we receive a very weak signal, areas in the picture which should be black are gray, because the signal is too weak to make them a clean black.

This type of trouble occurs more often with smaller stations. The larger stations, and the network originating stations, have very well designed automatic devices to prevent this. Fast-acting agc circuits in the video output (be-

fore the video signals are added to the sync) maintain a constant level. At times, troubles are found in the station itself. At one station, the agc circuit was installed, by mistake, in the output of the console going to the transmitter. Here, it controlled, not only the video, but the total amplitude of the signal, sync and all. Thus, when a white burst came along, the net result was not only overmodulation, but a severe case of momentary sync clipping.

One other question often heard concerns the ghost images seen on the screen after the cameras have been moved to another shot. Lettering from commercials, the newscaster's head, and other stationary objects can be seen on the screen, overlying the other subject. This is due to burning-in of the image on the mosaic of the image orthicon in the camera. It generally means that the tube has just about reached the end of its useful life. At times, even with a good tube, it is possible for an inexperienced camera operator to burn in an after-image on his screen by carrying his beam current too high. However, the chief engineer usually takes care of these gentlemen, especially after he watches a program or two.

Color shrinking

My RCA CTC4 color TV shrinks sideways on color programs only. Black-and-white reception seems OK. Width control is at its full-width position. High voltage runs about 23,000 volts.—J. I. H., Reseda, Calif.

I've run into this problem on several sets, including mine, and the answer seems to be something different

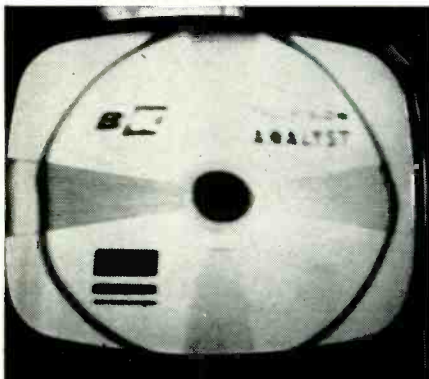

Fig. 1—Appearance of screen when transmitter is overmodulated.

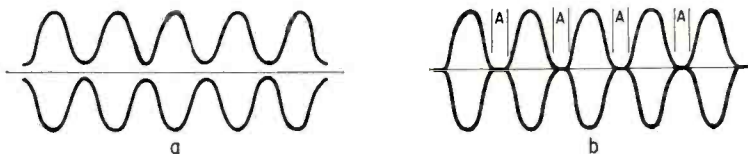

Fig. 2—Sine-wave modulation patterns. a—Note this rf output never drops below zero line. This is roughly equivalent to about 90% modulation. b—Overmodulation of carrier equivalent to about 120% modulation. Note, during intervals marked A, transmitter actually has no rf output. Therefore, total amount of energy being radiated is less and we get lower signal strength.

each time (shrinkage, that is, not necessarily on color only).

The major cause seems to be a very slightly weak 6CB5 horizontal output tube. Try replacing this tube, also the damper, and resetting the drive and high-voltage controls. Incidentally, RCA now OK's the replacement of the 6BL4 damper tube in this series with a 6AU4-GT. Since they brought the voltage rating up on the 6AU4, it will work here.

One more cause here might be burned resistors in the high-voltage lead. Check the three 22,000-ohm resistors inside the doghouse, near the high-voltage connector. They have gone out in several sets when the focus control went bad. While you're in there, have a look at R306, R276, the two 1-megohm resistors in the focus circuit.

There is one more rather unusual prospect in this circuit, the video amplifiers. Due to the weird circuitry (for black-and-white TV practice) used in the brightness and contrast control circuits, it is also possible for a defective final video amplifier tube or stage to cause a problem along these lines. In other words, if the video amplifier can affect the brightness, it can certainly affect the width, by changing the CRT beam currents. It's worth checking out, at any rate. Look for leaky coupling capacitors and shifted resistors in the video grid circuits.

By the way, you might look at the three pots in the screen control circuits, too. These parts carry the 800-volt B-boost voltage and they can run pretty hot and burn up sometimes. This causes color-hue drifting and assorted troubles along that line. However, if your background and color temperature are OK, they're OK too.

No vertical sweep

I have an Admiral 20Z4PS TV on the bench that is giving me lots of trouble. No vertical sweep. I read about 300 volts on the 6S4 plate, but there's no pulse there at all. I've tried a new yoke, without results. The two 18,000-ohm resistors from boost to the output transformer are overheating. I ought to get 580 volts on that plate, but it isn't there.—M. S., Monterey, Tenn.

I believe this trouble is going to be found in the vertical output transformer. It sounds as if it is leaking to ground. If the two 18,000-ohm resistors between boost and the bottom of the output transformer are overheated, something is causing excessive current drain in that circuit. If the tube has been changed and the yoke checked for grounds, then there is only one thing

left—that vertical output transformer (Fig. 3).

There is one other possibility, but I expect you've checked that: the 10- μ f electrolytic capacitor connected between the vertical output transformer (the red wire) and the 6S4 cathode.

Also check the 20- μ f electrolytic between cathode and ground. Incidentally, if the 10- μ f unit is shorted, it could have burned out the vertical linearity control, opening the cathode of the 6S4 or shorting it to ground through the bad capacitor. Both have been known to happen. Sudden opening of the cathode could have caused a spike of voltage to be fed to the transformer, causing the windings to break down to the frame.

You should read about 425 volts on the load side of the two 18,000-ohm resistors and about 410 volts on the 6S4 plate. Check the resistors for signs of changing value due to overheating.

Double-trouble

An RCA KCS-49 keeps blowing the ¼-amp fuse in the high-voltage supply. Whenever I change it, the set plays for a while (several hours to a day or two) and then it blows again. I changed the 6BG6-G and the damper tube, and it blew just as soon as the high voltage came up! The only trouble I can find is a charred resistor feeding the vertical output transformer primary from the boost. I replaced the resistor and the 6K6 vertical output tube. This time

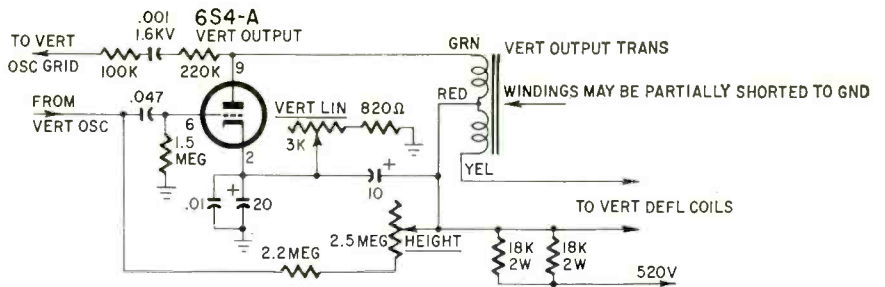

Fig. 3—No vertical sweep in this circuit may be caused by the vertical output transformer windings being partially shorted to ground.

it played for about ½ hour before the fuse went out again!—K. M., Pittsburgh, Pa.

It looks as if the thing is trying to throw you a curve, with that burned resistor in the vertical circuit. From the description, I'd say that this was the result of a previous short in the vertical output tube some time ago. The only cause for this trouble (in that circuit) would be an intermittent short to ground in the vertical output transformer and this would cause a different set of symptoms. Every time this has happened to me, the immediate result has been a sudden collapse of the vertical sweep (the thin white line) followed by the fuse blowing.

I think you'll find the trouble in the horizontal output circuit. Look for excessive screen voltage on the 6BG6-G, an intermittent short in the width control or the horizontal drive trimmer.

Check plate current of the 6BG6-G. This should be 80 to 105 ma and never over 105 ma.

Check the dc drive voltage on the 6BG6-G. This should be about -22. I would recommend monitoring as many of these voltages as possible simultaneously while watching the set to see what happens when the fuse goes.

You might try replacing the 6W4 damper tube with a 6AU4 (which has a much higher heater-cathode breakdown rating) and clipping off the heater-cathode jumper at the socket. There is a possibility of an intermittent ground in the damper heater winding in the power transformer.

Needs a flyback

I'm working on a Crosley 10-416MU set with a burned-out flyback. The original part number is NAC 147428. I can't get one anywhere. Can

MAKE YOUR INTEREST IN ELECTRONICS PAY OFF

Get
Into...

The HIGH PAY—PRESTIGE Field of TECHNICAL WRITING

HERE'S WHAT YOU GET . . .

- 50 Meaty Lessons
- Over 110 pages on Electronics
- Covers ALL Military Specifications
- Real, practical writing projects
- Full consultation privileges
- Many manuals, charts and diagrams
- Low tuition terms
- Employment Assistance
- Close, personal supervision
- AND MUCH, MUCH MORE . . .

TECHNICAL WRITERS NEEDED NOW—ATWS will train you at home at low cost for a profitable career in TECHNICAL WRITING. Thousands needed. Get in on the ground floor of this fascinating new field. ATWS offers training specifically designed for the needs of industry. Course includes everything you need to become a top-notch Tech Writer. **YOU ARE JUST A STEP AWAY FROM OPPORTUNITY** — The simple act of returning the coupon below can get you started. Technical Writing is one of the highest paying fields NOT requiring college training. It's tailor-made for YOU — but you must ACT NOW.

THIS COUPON CAN BE YOUR PASSPORT TO SUCCESS

Fill in your name and address and rush coupon for full information. We will prove to you that we can train you without interfering with your present income or job.

CAREER BOOK AND SAMPLE LESSON

American Technical Writing Schools, Inc. Dept. RE-52
5504 Hollywood Blvd., Hollywood 28, Calif.

Please RUSH full particulars.

Name _____ Age _____

Street _____

City _____ Zone _____ State _____

**BOTH
FREE**

NO SALESMAN WILL CALL ON YOU

TRAINING AMBITIOUS

MEN FOR INDUSTRY

American Technical Writing Schools, Inc.
5504 Hollywood Blvd.
Hollywood 28, Calif.

WORTH SHOUTING ABOUT!

NEW IMPROVED
MIGHTY MITE

Reaching New Peaks in
Performance, Portability and Price

MIGHTY MITE II

They're shouting from the hill tops. Technicians, engineers and test labs all say that the original Mighty Mite finds the tubes that large expensive testers miss. And now . . . here is the new improved Mighty Mite! Designed for the present and far into the future. Tests all of your present tubes plus the new RCA Nuvistors and Novars, GE Compactrons and Sylvania 10 pin tubes.

A complete tube tester that is smaller than a portable typewriter yet outperforms testers costing hundreds of dollars. A real money maker for the serviceman and a trusty companion for engineers, maintenance men and experimenters.

Even though the Mighty Mite weighs less than 8 pounds, new circuitry by Sencore enables you to use a meter to check grid leakage as high as 100 megohms and gas conditions that cause as little as one half microamp of grid current to flow. Then too, it checks for emission at operating levels and shorts or leakage up to 120,000 ohms between all elements. This analytical "stethoscope" approach finds troublesome tubes even when large mutual conductance testers fail. And it does all this by merely setting four controls labeled A, B, C, & D.

Check these plus Sencore features: Meter glows in dark for easy reading behind TV set • Stainless steel mirror in ad-



67⁵⁰ DEALER NET

Remember . . . there is only one Mighty Mite

justable cover for TV adjustments • Rugged, all steel carrying case and easy grip handle • Smallest complete tester made, less than one foot square. Mighty Mite II will test every standard radio and TV tube that you encounter, nearly 2000 in all, including foreign, five star, auto radio tubes (without damage) plus the new GE Compactrons, RCA Nuvistors and Novars and Sylvania 10 pin tubes.

Mighty Mite II also has larger, easy-to-read type in the set-up booklet to insure faster testing. Why don't you join the thousands of servicemen, engineers, and technicians who now own a Mighty Mite tube tester? Tube substitution is becoming impossible and costly with nearly 2000 tubes in use today. Ask your authorized Sencore Distributor for the New Improved Mighty Mite. Size: 10¼" x 9¼" x 3½" Wt. 8 lbs.

MODEL TC114

Sencore Sam says . . . "They all agree . . . the Mighty Mite is the real answer for the man on the go."



SENCORE ADDISON, ILLINOIS

PUT MORE ON YOUR TAPE

By JAMES MASKASKY

Nearly all systems for multi-channel tape recording are either too complicated or too expensive for the average audiophile. There is one method you can easily experiment with at home. By taking advantage of an angular property of tape recording, you can record and play back six or more channels with one ordinary half-track tape head.

Before we go any further, one condition behind this system must be made clear. When recording, the erase head must be disabled. If you have a recorder with permanent-magnet erase, you have no problem—simply remove the erase magnet. But if you have a tape recorder with a multiple-function head, you may not be able to disable the erase head. If you have a recorder with a separate erase head, remove the head but leave it connected. Its inductance may be a part of the bias oscillator circuit. If it is and you disconnect it, you will not be able to record properly. I added an additional record-playback head on a special mount so it could be rotated as desired. Naturally, I selected

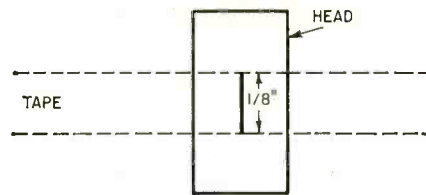

Fig. 1—A half-track record head has a gap that is slightly less than $\frac{1}{8}$ inch high. For convenience $\frac{1}{8}$ inch is used.

a head that matched my recorder. I left the erase function on the original head.

How it works

In ordinary tape recording, the record head is perpendicular to the tape and the signal recorded on the tape runs the full height of the gap in the record head (a trifle less than the $\frac{1}{8}$ inch for half-track heads, shown in Fig. 1). Now if we rotate the record head 60° to the right, we can rerecord the portion of the tape that is now covered by the tape-head gap height.

Fig. 2-a shows this vertical height to be $\cos 60^\circ$ times the original height: $\frac{1}{2} \times \frac{1}{8} = 1/16$ inch for the height of the remaining part of the first channel. A picture of the tape after this two-channel recording is in Fig. 2-b.

Before we discuss playback, let's look into some elementary tape recording theory. If a tape is recorded at one angle and played back with the head at a different angle, signal strength drops and distortion increases. This becomes increasingly noticeable as the playback angle increases relative to the record angle.

Playback problems

Now let's go back to our prerecorded tape (Fig. 2-b). The second signal, recorded at 60° , can be played back if we turn the playback head to the same angle. Since this is the only signal that crosses the tape head, it will be the only one audible.

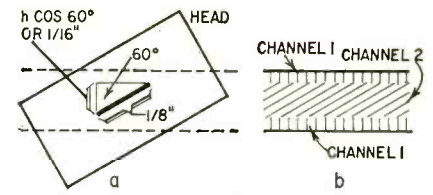

Fig. 2—Composite diagram shows the signal on the tape when two channels are recorded on the same track.

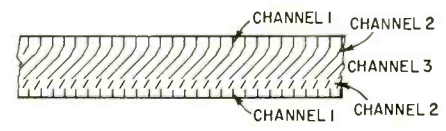

Fig. 3—Here, three channels are recorded on a single track.

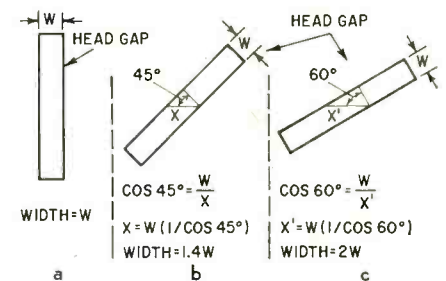
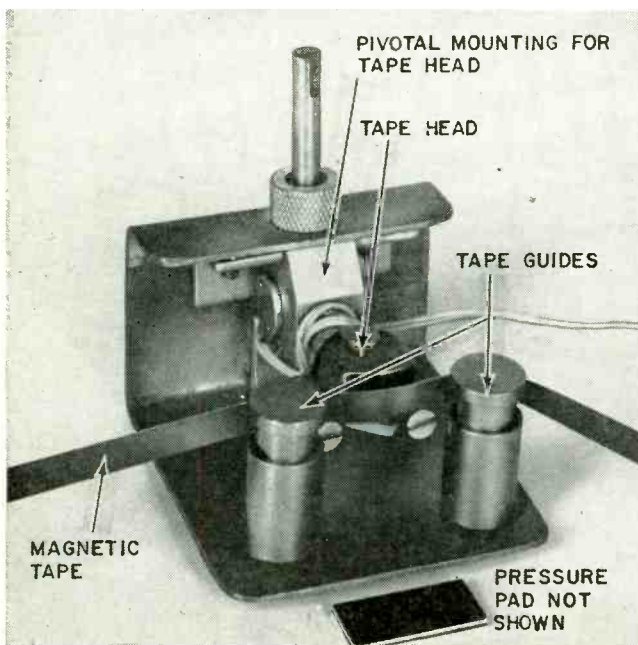

Fig. 4—How gap width is figured for various angles of tilt.

Rotating the tape head back to 0° we get the remaining portion of the vertical signal on the extremes of the tape head, and the second signal at an angle of 60° in the middle of the tape head. Since this angle is large enough to cause a significant reduction in volume of the middle signal, we hear only the signal originally recorded on the first channel.

By expanding this one more step, we can see that by choosing a number of angles, three or more signals can be recorded on each half track. The theoretical angles for three channels would be: $(\cos^{-1} 1)$, $(\cos^{-1} \frac{1}{2})$, and $(\cos^{-1} \frac{1}{3})$.



The author used this arrangement to tilt the head to the desired angle. Assembly has its own built-in tape guides.

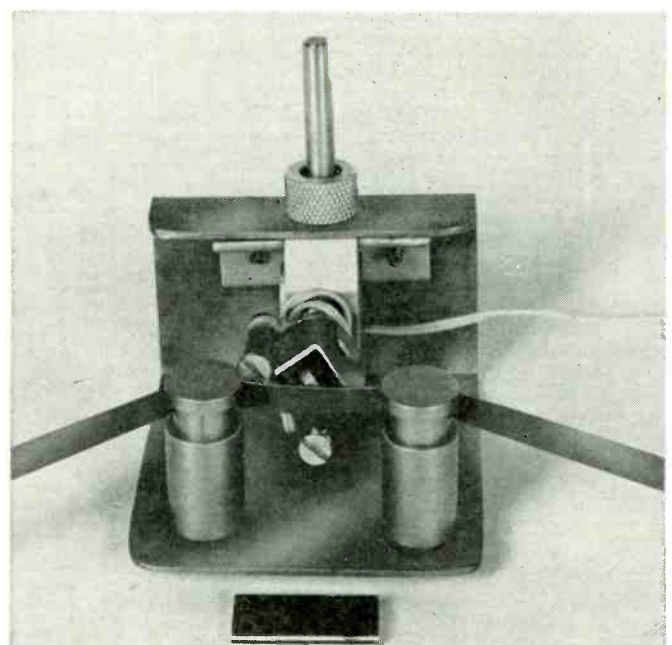

The tape head has been rotated 60° .

In numbers, this would be approximately 0°, 48° and 70°, but for practical reasons (they're explained later) 0°, 45°, and 60° were chosen for three channels. Fig. 3 shows the magnetic pattern of this three-channel system. For four channels, the angles could be 0°, 40°, 55° and 70°.

One question some reader may be asking at this point is, "Why was 90° ruled out as a limit?" For this apparatus, it is impossible to get an adequate signal at 90° because the gap height (1/8 inch) becomes the tape-head gap width seen by the tape, which means that at 7 1/2 ips, the top theoretical frequency is 30 cycles.

Angle vs response

This reminds us that we had best consider the effective gap width and the frequency response for the angle we intend to use. In Fig. 4 we have illustrated what happens in our three-channel system, but the same thing happens to any number of channels. As illustrated in Fig. 4-a, the vertical signal width equals $W(1/\cos 0^\circ)$, or W , where W represents the original gap width. For the second angle, the effective width equals $W(1/\cos 45^\circ)$, or 1.4 W . For the third channel, it is $W(1/\cos 60^\circ)$, or 2.0 W . This is shown in Figs. 4-b and 4-c.

Since the top frequency is inversely proportional to the gap width when the tape speed is constant, the result is that

This novel way to increase the amount of information recorded on a magnetic tape won the author a prize in a New Jersey science-fair competition for high-school students last year. The editor and several experts in tape recording were so impressed with the originality of the idea that we asked Mr. Maskasky to write an article describing it. The author has since graduated from high school and is now enrolled at the Massachusetts Institute of Technology, the first step, we are sure, to a successful career in electronics.

the top frequency for channel 2 is 0.7 times channel 1's top. And channel 3 is 0.5 or 1/2 the maximum frequency of channel 1.

A few practical experiments showed that any recorded selection with an angle greater than 70° was too poor in quality and too difficult to tune to be of any use. This is why 60° was chosen as the largest for three channels, leaving 45° as the best possible choice for the other angle.

The measured crosstalk for two channels (0° and 60°) was better than -60 db. For three channels (0°, 45° and 60°) it was -46 db between the second and third channels, and -52 db for the second and third signals on the first.

In making the pivotal apparatus to mount the tape head:

▶ Use extremely flexible audio lead to the tape head or it will break under the constant stress.

▶ Pivot the tape head around its central axis to get symmetrical recording for best results.

▶ Eliminate all play or looseness. If you don't, you will be extremely lucky to find your original signal.

▶ Locate the vertical signal in its normal position on the tape to get twice the time by flipping over the reel.

▶ Disconnect the erase head before attempting to record.

The tape head pivoting device I used is shown in the photos. It was custom built. However, there are other methods that can be used. A multi-position rotary switch might make a good replacement for the 90° drive shown. Or the spring stops could be taken out of the switch and friction used to maintain a constant setting of tape head. This would be done by placing a spring on the shaft driving a metal plate on the "free" end to form a tight clutch against the housing.

This method of recording offers simplicity of operation, saving of money on prerecorded tapes, and no need for ultra-critical factory adjustments. The system does not eliminate the need for separate tracks. Instead, it enables us to put much more information on the width of tape used for each track.

Minor improvements in the apparatus and technique can raise the quality of this system to comply with high-fidelity standards. From there, the possibilities are limitless. END

ALL NEW SENCORE component substitutor



MODEL RC121

All your favorite Sencore Substitution Time-Savers in One Compact Unit

A complete range of carbon resistors, wire wound power resistors, capacitors, electrolytics, and universal selenium and silicon rectifiers.

Imagine, all of these hard to locate parts at your finger tips for on the spot substitution. Say goodbye to messy, crumpled parts, unnecessary unsoldering and soldering of components for testing purposes only. Save valuable servicing time and be sure, by substituting.

NEW . . . each section operates independently with a value close enough for every substitution need. Components in each section are isolated from chassis and from the other sections. For example, a complete power supply can be constructed using the RC121 Components only.

NEW . . . dual electrolytics provided. A new circuit enables you to substitute up to 25 single electrolytic values or 9 duals. Exclusive surge protector provides protection on both singles and duals for both you and the circuit.

You save space and money. Equivalent Sencore substitution pieces purchased individually (H36, PR111, RS106, ES102) cost you \$54.00

RC121 (all hand wired, all American made) only **39.95**
RC121K (Kit) 27.95

Now in stock at your Sencore Distributor. See him today!

SENCORE
ADDISON 2, ILLINOIS

high-voltage substitution speeds TV servicing

How to avoid
losing your shirt
on "no raster" calls

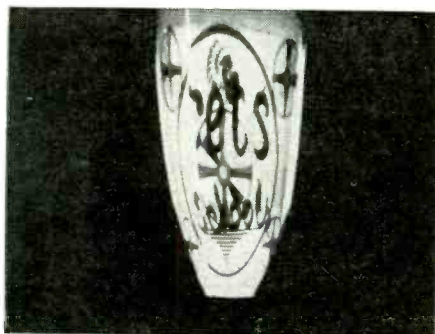

Fig. 1—This keystoneed raster was caused by a shorted yoke.



Fig. 2—Long narrow raster with a heavy drive line down the center was caused by the screen-grid resistor on the horizontal output tube increasing in value.

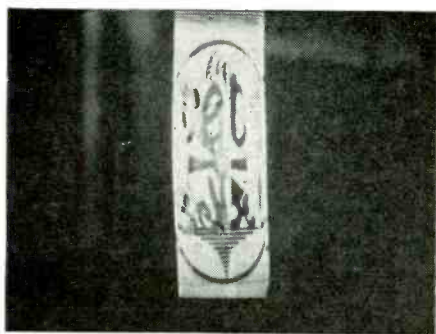

Fig. 3—Very narrow raster with an extreme case of poor horizontal linearity. Note foldover on left side of screen. A linearity capacitor (B-boost filter) had decreased in value.

By DELLROYE D. DARLING*

Ask the average service technician what's the toughest part of his business and he will say, "Estimating!"

Most customers are pretty insistent about learning the price of a repair job before they give an OK to go ahead. On some complaints a good technician can pretty well guess from the symptoms just about what the job will cost. But what do you do when the only symptom you have is no raster?

You can pull the anode lead and check for high voltage by arcing it to the chassis but, if high voltage is missing, (and it usually is in these cases), you still don't know very much.

Is it the yoke? Maybe. On the other hand, it could be the horizontal output transformer, or no B-plus, or an open screen grid resistor on the horizontal output tube, and so on. All these can kill the raster, but an estimate based on a burned resistor will hardly cover a shorted flyback transformer.

The main difficulty is that even though these troubles cause symptoms of their own which could be used to identify them, they all cut off the high voltage, so the identifying symptoms can't be seen.

Now, signal substitution from a working set to a defective one is nothing new, nor is high-voltage substitution. However, even many technicians who use this technique don't realize how much it can simplify estimating, and so don't use it often enough. Even if estimating isn't the real problem, substitution can save time, and time is money!

Case history

Let's take a typical case. You have a 21-inch Motorola on the bench. It has no raster, and the customer wants an estimate. Ordinarily, we would almost have to repair the set before we could tell all that was wrong with it. But let's do it the easy way.

Take another set — any set that has normal high voltage — and set it up alongside our dog. Plug both sets in and turn them on. Naturally, the outside man has tried tubes, so we shouldn't need to go into that. Pull the anode lead out of the pix tube connector on both sets. Connect a jumper between both chassis. Connect a well insulated jumper between the anode lead on the good set and the anode button on the defective one. (It's a wise idea to turn the "good" set off while making this connection.) Make sure the brightness control is turned well up on the dog. Aha! Now we

have a raster. But look at its shape. (Fig. 1) It's trapezoidal, or keystoneed.

Any good technician knows the one thing that can cause keystoneing. This set has shorted turns in the deflection yoke. Now we have something on which to base a reasonable estimate.

Take another step

But wait, why not kill two birds with one stone? Every once in a while we make an estimate based on no raster, the customer OK's the job, then when we fix the raster problem we find the set also has video troubles that we couldn't see before. This means persuading the customer to accept an increased estimate so the job can be completed. This seldom improves his opinion of TV service technicians.

As long as we have the high voltage from the good set giving us a raster, why not connect an antenna to the defective set and have a look at the picture? Naturally, if the raster is distorted, the picture will not be completely normal, but we can at least tell if the contrast is correct, all channels present, sync OK, etc.

Other troubles

Let's see what symptoms some other no-raster troubles can cause. Suppose our high-voltage substitution reveals a narrow raster with a very bright drive line down the center (Fig. 2). This is a sign of an overdriven horizontal output tube. If the tube is good, there is one other common fault that can cause these symptoms — an increased value of the screen-grid resistor in the horizontal output tube circuit.

Ordinarily, we know that defective vertical circuits can cause a single horizontal line on the screen. However, if something has shorted in the vertical section (usually supplied from boosted B-plus), it can also cause loss of raster. High-voltage substitution will produce the horizontal line that tells us definitely that the trouble is in the vertical section.

A narrower-than-usual raster with extremely poor horizontal linearity (Fig. 3) can be caused by a shorted linearity coil. This set does not have a linearity control, but a little thought suggested that the trouble might be in a linearity capacitor (B-boost filter). Sure enough, one of them had decreased from 0.1 μ f to a negligible value.

Although any technician is familiar with a horizontal white line on the screen caused by loss of vertical sweep, not many have seen a vertical line (Fig. 4), because most faults that can produce this condition also kill the high-voltage supply.

Several things can cause this line, but much can be learned from it. For

*Director, Industrial Electronics Radio Electronic Television Schools, Detroit, Mich.



C-25. IN-CIRCUIT CAPACITOR TESTER KIT. Reveals shorted or open capacitors in the circuit, including electrolytics. Also reveals dried-out electrolytics through the Electrolytic Capacitance Dial. Kit: \$19.95; Factory Wired, ready to operate: \$29.95.



V-70. VACUUM TUBE VOLTMETER KIT. Uses stabilized bridge circuit to provide measurements on 7 DC and 12 AC voltage ranges, plus 7 decibel and 7 wide-spread electronic ohmmeter ranges. Kit: \$31.95; Factory Wired, ready to operate: \$49.95.



G-30. RF SIGNAL GENERATOR KIT. Highly accurate, stable. Also designed for use as a Marker Generator in sweep-alignment procedures. Eight frequency ranges: 160 kc to 240 mc. Kit: \$32.95; Kit with Prealigned Tuner: \$39.95; Factory Wired, ready to operate: \$44.95.



MX-100. STEREO MULTIPLEX ADAPTER KIT. All critical circuitry factory adjusted and prealigned. Maximum stereo separation between 20-15,000 cps, with low distortion. Stereo switch permits either front-panel separation control or maximum separation adjusted at factory. Kit: \$49.95; Factory Wired, ready to operate: \$69.95.



ST-26. FM TUNER/AMPLIFIER KIT. Low-cost combination hi-fi FM music system. Requires only the addition of external speaker (see L-3) to complete system. Pre-Built Front End fully adjusted and prealigned at factory. Kit: \$54.95; Factory Wired, ready to operate: \$69.95.



L-3. SPEAKER SEMI-KIT. Ultra-compact, graciously styled system. Lifelike response from high-efficiency speakers. Walnut-finished cabinet. Size: 13 1/4" L x 6 1/2" H x 7 1/4" D. Semi-Kit: \$19.95.

PACO KITS
THE KITS YOU BUILD IN 1/3 LESS TIME



FROM BOX...



TO BEETHOVEN IN 1/3 LESS TIME!

In timed, competitive tests, twin brothers — with twin backgrounds and skills — proved that Paco kits are faster, easier and more fun to build than almost-identical kits sold by other kit makers. They discovered that there's no guessing with Paco: parts are neatly packaged and precisely labeled; instruction books are complete and easy to follow. Accurate drawings to actual scale and fold-out diagrams are printed right next to step-by-step directions. ■ The twins also proved that Paco pleasure doesn't end with the wiring. The ST-25 MX FM Stereo Multiplex Tuner®, for example, looks and performs like twice the price: frequency response is 30 to 20,000 cps within 2 db; sensitivity is 1.5 μ v for 20 db quieting. It features self-contained, prealigned and fully shielded front end, FM Stereo multiplex circuitry, dual limiters, AFC with panel switch for AFC defeat and "eye"-type tuning indicator. Why not put Paco to your test. Kit: \$69.95 net, (factory wired, ready to operate: \$99.95). See your dealer or write today for details to Paco Electronics Co., Inc., 70-31 84th Street, Glendale 27, New York, a division of Precision Apparatus Company, Inc. Export: Morhan Corporation, 458 Broadway, New York 13, New York. In Canada: Atlas Radio Corporation, 50 Wingold Avenue, Toronto, Canada.

*AS PICTURED ABOVE

PACO KITS 
THE KITS YOU BUILD IN 1/3 LESS TIME

NEW SAMS BOOKS



How To Read Schematic Diagrams

Really shows you how to read and interpret diagrams. Not just a simple key to schematic symbols, but an easily understandable text analyzing each component, its construction and the effect it has on the circuit. 10 chapters: Types of Diagrams; Symbols of Resistors; Capacitors; Coils & Transformers; Tubes; Semiconductors; Switches & Relays; Miscellaneous Components; Connecting Components; Schematic Interpretation; Industrial-Electronics Symbols. \$1.50 128 p., 5 1/2 x 8 1/2". Order RSD-1, only.

ABC's of Mobile Radio

A basic introduction to the systems and equipment used in today's booming field of 2-way mobile radio communications. Valuable to technicians, users and potential users who want a technical understanding of the equipment. 5 chapters: 2-Way Radio Communications; The Transmitter; The FM Communications Receiver; Power Supplies & Interconnecting; Antennas. 96 p., 5 1/2 x 8 1/2". Order AMR-1, only.

Electronic Servicing For The Beginner

An introduction to basic troubleshooting methods for radio, TV, hi-fi, ham gear, etc. Enables you to learn by building a variety of carefully selected, useful equipment (including an all-transistor signal generator), and shows you how to perform actual tests of each unit. You'll learn how to make quick checks, how to read a multimeter, signal-injecting and signal tracing, how to use service literature, make voltage checks, etc. 160 p., 5 1/2 x 8 1/2". \$2.95 Order BSJ-1, only.

Electronic Musical Instrument Handbook

The first really comprehensive book explaining purely-electronic and amplified musical instruments. Describes operating principles of stringed, wind and percussion instruments; explains how mikes and special pickups are used for music reinforcement; tells how the transducer, electronics and instrument are combined; includes chapter on purely electronic instruments with explanations of systems of music synthesis; covers circuitry, installation, maintenance. 128 p., 5 1/2 x 8 1/2". Order EMI-1, only.

Modern Infrared Technology

The countless new uses of infrared energy are rapidly developing a technology which this much-needed book thoroughly explores. Provides a complete background on infrared for technicians, engineers, hams, and hobbyists. Fully describes infrared radiation; applications in communications surveillance, detection, solid-state physics, telemetry, etc.; 9 chapters cover theory, application and devices. 256 p., 5 1/2 x 8 1/2". Order INF-1, only.

Computer Basics: Solid State Computer Circuits

Follow-up to the famous Sams COMPUTER BASICS 5-volume work. A complete book in itself, it is complementary to the prior volumes. Describes in 13 chapters the latest use of semiconductors in analog and digital computers. Includes all latest developments: embedded modules, thin-film techniques, micro-miniaturization, modular repair techniques, testing procedures, etc. Profusely illustrated. \$4.95 224 p., 5 1/2 x 8 1/2". Order CSS-6, only.

All 6 COMPUTER BASICS Volumes \$27.00

NEW! VOL. 14 AUTO RADIO MANUAL!

Just out... coverage of 60 popular models produced in 1960-61. Complete Photofact® data on each model. 160 p., 8 1/2 x 11". Order AR-14, only.

HOWARD W. SAMS & CO., INC.

Order from your Sams Distributor today, or mail to Howard W. Sams & Co., Inc., Dept. E-22 1720 E. 38th St., Indianapolis 6, Ind.

Send me the following books:

- RSD-1 AMR-1 BSJ-1 EMI-1
 INF-1 CSS-6 6 Vol. Set AR-14

\$..... enclosed. Send Free Book List

Name _____
 Address _____
 City _____ Zone _____ State _____
 IN CANADA: A. C. Simmonds & Sons, Ltd., Toronto 7
 (outside U.S.A. prices slightly higher)

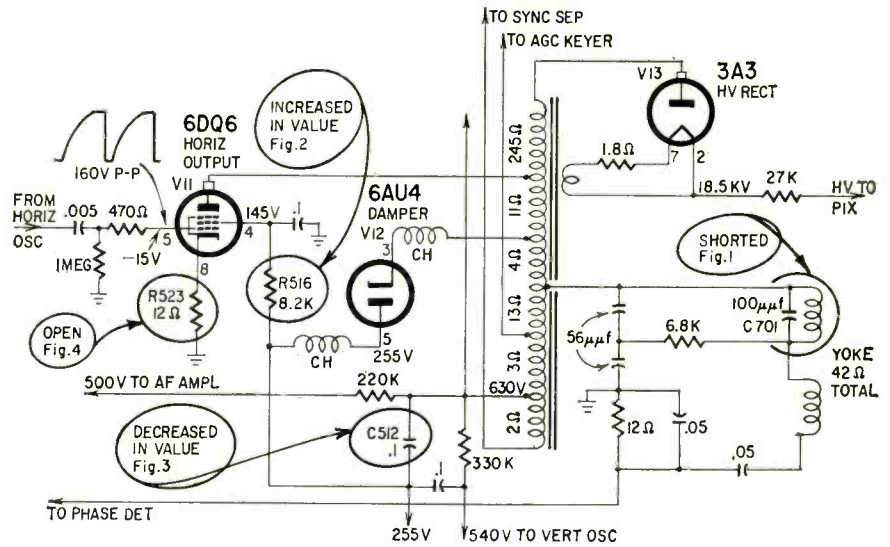

Motorola TS-544A-00 high-voltage circuit used as example in this article.

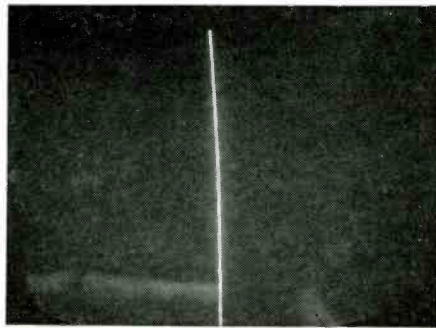

Fig. 4—Open cathode resistor in the horizontal output stage will produce this symptom of no horizontal sweep.

instance, the fact that the vertical sweep is operating to some extent indicates

that the damper tube is at least conducting (in a modern series damper set). This time it was caused by an open cathode resistor in the horizontal output stage.

Now, every story has two sides, and this one is no exception. High-voltage substitution is no magic wand. Even a good man who has used the idea for some time will occasionally make a wrong diagnosis. It is a qualitative tool, somewhat like an oscilloscope. It doesn't read good—bad like a tube checker. We have to learn to interpret what we see, mix it with some experience and come up with an educated guess. However, no really good technician needs to be told that anything that will improve his guessing will improve his income and his disposition, too! END

What's Your EQ? April Solutions

Too-Automatic Tuner

This chassis uses an ultrasonic automatic tuner circuit, operating around 45 kc or so. When horizontal hold was thrown off frequency, either the fundamental or a harmonic, radiated as sonic waves by the flyback or yoke, got into the input of the automatic tuner, which is a microphone at the front of the chassis! Turning the horizontal hold control would cause the auto-tuner to react on one of its functions, depending upon the frequency being generated by the horizontal output at the time!

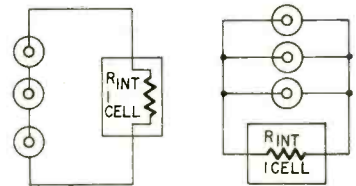

plus the resistor in the box. With the cells in parallel, the voltage of one cell is applied to the resistance in the box plus the resistance of one cell divided by the number of cells. Try it with a couple of examples!

Why the Decrease?

Let's look inside.

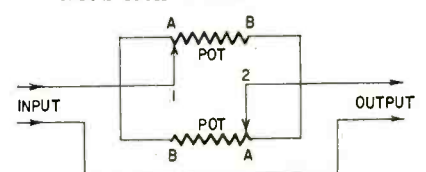

Black Box No. 4

The black box contains a resistor equal to the internal resistance of one cell, as shown in the figure. When the cells are in series, the current is equal to the total voltage divided by the sum of the resistances of each of the cells

FREE!

LAFAYETTE

340 GIANT-SIZE PAGE
1962 ELECTRONICS CATALOG #620

"America's Hi-Fi & Electronics Shopping Center"

Yours free for the asking — the biggest, best and most comprehensive catalog in the 41-year history of Lafayette Radio. Audiophile, Experimenter, Hobbyist, Technician, Engineer, Student, Serviceman, Dealer — you'll find what you want in this latest Lafayette catalog.



CATALOG # 620

NEW!

NEW! CB TRANSCEIVER
 with 8 CRYSTAL CONTROLLED CHANNELS.
 HE-20B 109.50

CB "WALKIE-TALKIE" CRYSTAL CONTROL RECEIVE AND TRANSMIT.
 HE-29AL Net 39.95
 2 for 78.88

10,000 OHMS-PER-VOLT MULTITESTER
 TE-10 9.95

SUPERHETERODYNE COMMUNICATIONS RECEIVER
 KT-200, Kit 64.50
 HE-10, Wired 79.95



FM MULTIPLEX ADAPTOR Kit. Fits wide-band tuners with or without MPX output jacks.
 KT-220 Net 19.95

NEW!

CITIZENS BAND MOBILE ANTENNA WHIP
 HE-800WX 6.95



LARGEST STOCK SELECTION. Stereophonic Hi-Fi equipment, Citizens Band, Ham and Amateur equipment, Radio & TV parts, Optics, Industrial Supplies, and much more, including all the favorite name brands.

LAFAYETTE EXCLUSIVES. Featured are the famous Lafayette Kits . . . dollar for dollar the best value for your money today. You'll also see hundreds of Lafayette specials . . . available only from Lafayette. And, as always, **SATISFACTION GUARANTEED OR MONEY REFUNDED.**

LOWEST PRICES. You'll save money too with Lafayette's low, low prices. The lowest prices are always in the Lafayette catalog.

24-HOUR SERVICE. Quick, courteous service is your guarantee at Lafayette. Most orders are fully processed within 24 hours after receipt in the mail Order Division.

NEW EASY-PAY PLAN.
 Now, **NO MONEY DOWN . . .**
 up to 24 months to pay.

LAFAYETTE'S
 NEW MAIL ORDER and SALES CENTER
 111 JERICHO TURNPIKE
 (2 Blocks West of South Oyster Bay Rd.)
 SYOSSET, LONG ISLAND, NEW YORK



LAFAYETTE RADIO DEPT. JE-2
P.O. BOX 10, SYOSSET, L. I., N. Y.

Rush my FREE Lafayette 1962 Catalog 620
 Please send me # _____, shipping charges collect.
 I am enclosing \$ _____.



340 PAGES

Name _____
 Address _____
 City _____ Zone _____ State _____

A VARIABLE-VOLTAGE TRANSFORMER

You can save money by adding a case, fuse, receptacle and meter posts to the basic autotransformer

By L. A. JAMES

MANY pieces of equipment found in industrial and commercial electronic laboratories would be valuable in the home electronic workshop. Many of these are too expensive for once-in-a-while use, but this one isn't. One of the most often used pieces of equipment in the professional lab is a variable-voltage transformer. This type of transformer is available under such trade names as Variac, Adjust-A-Volt and Powerstat. Prices run from \$8.50 to over \$100.

For the average home workshop, the smallest size, 165 volt-amperes, should be adequate. It can be connected so that it will provide an output from 0 to 135 volts. For those of you who aren't familiar with the variable-voltage transformer, perhaps a word of explanation is in order.

Round laminations are used. Along one side, the enamel is removed from the wire and a contact brush rides on this scraped wire. You may remember that a toy-train transformer is made somewhat like this. Since the variable-voltage unit is round, it is hard to handle and set up for use. Several dollars can be saved (and some enjoyable hours had) by making the housing and mounting and wiring the components yourself.

A fuse holder, pilot light, on-off switch, ac receptacle and a pair of binding posts are added to make the transformer more useful. The binding posts are very handy for connecting a meter to monitor the output voltage. The photographs show how the parts are mounted. Be sure to use as least No. 18 hookup wire, on all connections (except the pilot light and voltmeter terminals). You will note that the fuse holder is wired between the transformer and receptacle. A 1-ampere fuse gives the maximum amount of protection to the transformer (rated at slightly over

1 ampere) which is the most valuable component in the circuit.

After wiring, the unit should be tested. If you have an ac voltmeter, use it; if not, a light bulb can be connected to the receptacle. With the transformer set at zero, turn on the power. The pilot light should glow. Slowly advance the

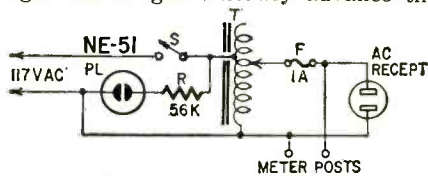

Schematic of transformer.

control knob and the output voltage will increase and the bulb will glow more brightly. Remember that you can get up to 135 volts from the unit, which may burn out the bulb. As you find more and more uses for this piece of equipment, you will wonder how you ever got along without it. **END**

- R—56,000 ohms, 1/2 watt, 10% (use only if pilot assembly does not have built-in resistor)
- T—0-135 volts, 165 volt-ampere variable transformer (Powerstat model 10 or equivalent)
- F—1 ampere, 250 volts and fuse holder
- S—spst toggle
- PL—NE-51 and pilot assembly (Dialco 931 or equivalent)
- Binding posts
- Ac receptacle (Cinch 2R2 or equivalent)
- Case 3 x 4 x 5 inches

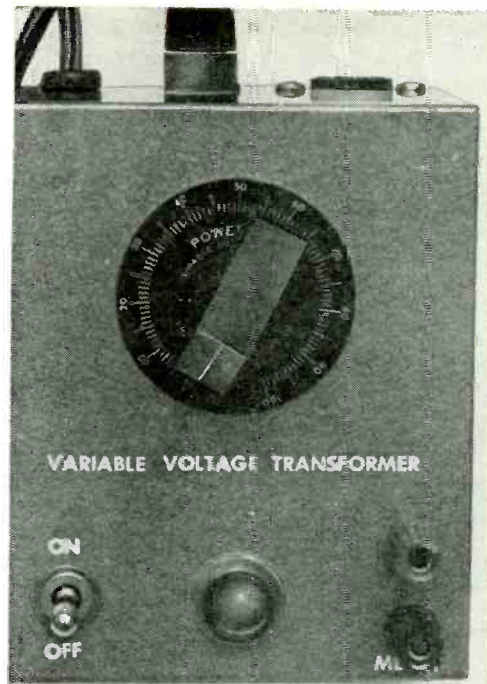

Output voltage is variable from 0 to 135 volts and may be metered from posts on panel.

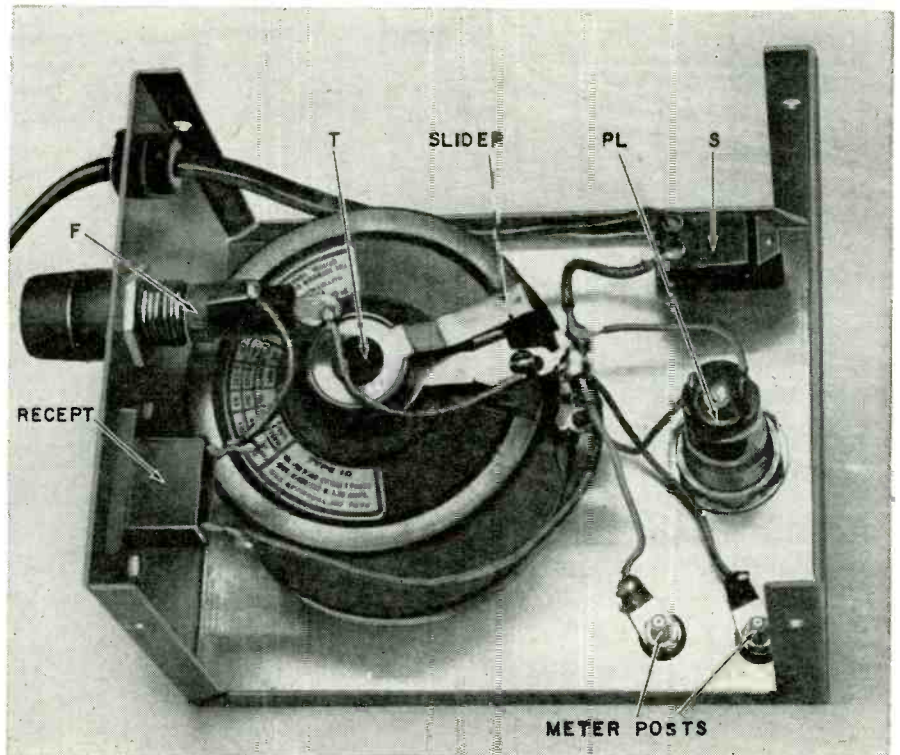

Note comfortable layout. Plenty of space means a cool-running unit.

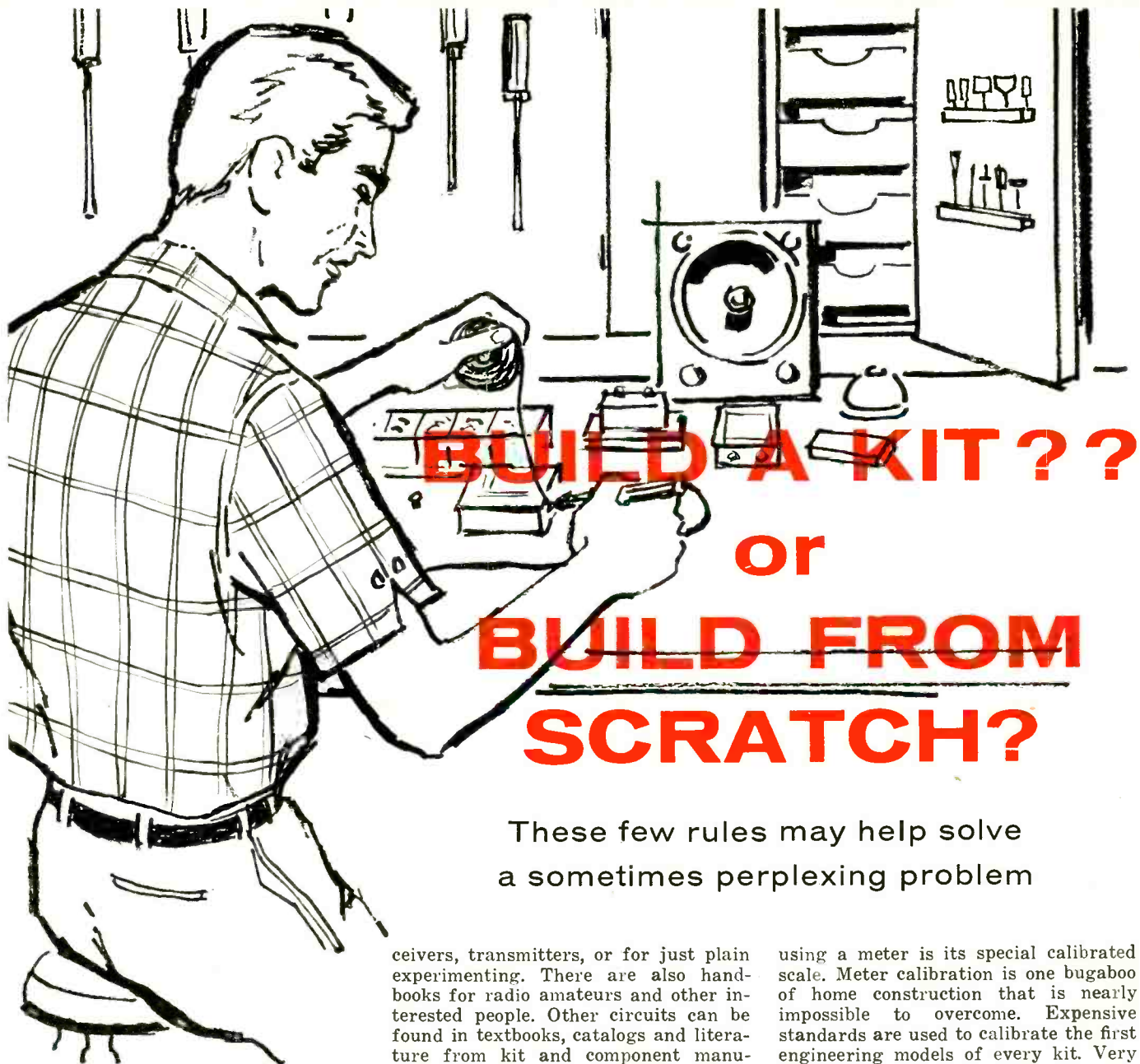

BUILD A KIT?? or BUILD FROM SCRATCH?

These few rules may help solve
a sometimes perplexing problem

By JAMES A. FRED

TO PARAPHRASE WILLIAM SHAKESPEARE, "To build a kit or not to build a kit, that is the question." The old-timers are amazed to see so many thousand kits being built, while hardly anyone builds a piece of electronic equipment from scratch. Time was when most hobbyists designed their own units, fabricated the sheet metal, mounted parts, wired, tested and finally used the item. Now the electronic enthusiast sits down with a catalog of kits and in a few minutes has made his choice and sent in the order. As one of the few survivors who like to build from scratch, I decided to examine the pros and cons of each side—see if I could find out why kits are so popular.

There is no shortage of good construction articles on almost any facet of electronics, in this and the other magazines devoted to electronics. You can find circuits for audio amplifiers (mono or stereo), test equipment, re-

ceivers, transmitters, or for just plain experimenting. There are also handbooks for radio amateurs and other interested people. Other circuits can be found in textbooks, catalogs and literature from kit and component manufacturers.

Attractive metal cabinets to house the home-built equipment are far easier to get than when everyone built from scratch. More than a half-dozen companies specialize in metal cabinets and chassis of all sizes, shapes and descriptions. They also come in several materials and colors.

More parts and components are available than ever before. You can obtain them by mail, wherever you live, at attractive prices. All the magazines carry advertisements of new and different components as soon as they become available. Meters are available to measure any value of voltage, current or resistance.

On the other hand, did you ever try to figure up the cost of all the parts in a kit? We did. The price of the parts contained in a kit would cost twice as much as the kit if they were purchased separately. There are also special parts in many kits that would be hard or impossible to purchase.

One outstanding feature of any kit

using a meter is its special calibrated scale. Meter calibration is one bugaboo of home construction that is nearly impossible to overcome. Expensive standards are used to calibrate the first engineering models of every kit. Very few home experimenters have access to precision standards such as those needed for meter calibration. The printed or silk-screened meter scale is also out of reach.

One thing that sets a kit apart from home-made equipment is the front panel. Most kits use a silk-screened or etched design on the front of the cabinet. The cost of the artwork and making the screen often exceeds the cost of a complete kit.

Another desirable feature of a kit is the calibrated frequency dial. Just as in the case of the meter scales, expensive signal frequency standards are needed to calibrate the prototype dial scales. The home experimenter does not have these frequency standards.

Many experimenters have boxes of radio parts on hand in the so-called "junkbox". I know one who has been accumulating components for over 14 years. He has salvaged many war surplus parts, he has junked several TV sets and has had many items given to him. This man seldom buys a kit be-

**RESIDENT SCHOOL COURSES
IN NEW YORK AND LOS ANGELES**



Industry needs Electronic Technicians!

**Let RCA
train you in
Advanced Electronics**

This is the college-level training you need to work with professional engineers on research, development, or production projects in such fields as: automation, guided missiles, radar, television, computers, and other advanced electronic applications.

RCA Institutes Resident Schools in New York City and Los Angeles offer this comprehensive course that prepares you for any field of electronics you may choose. Other courses in TV and General Electronics, Radio and Television Servicing.

Classes start four times each year. Applications now being accepted.



RCA INSTITUTES
SCHOOLS OF TELEVISION & ELECTRONIC TECHNOLOGY
A Service of Radio Corporation of America

-Send to the school nearest you!

RCA Institutes, Inc., Dept. ZRE-52

350 West 4th Street
New York 14, N.Y.

Pacific Electric Building,
Los Angeles 14, Calif.

Please send me your FREE catalog of Resident School courses.

Name _____
(PLEASE PRINT)

Address _____

City _____ Zone _____ State _____

For Home Study Courses See Ad On Opposite Page

cause he has almost all the parts needed for any project he may decide to work on. He also enjoys the mechanical work that goes into laying out sheet metal and drilling and punching the holes.

Building a kit gives this man very little challenge. He owns only two kit instruments even though he has wired and assembled more than 30 kits for other people. He built his kit oscilloscope according to the instruction manual and it is still in its original form. His other kit, a vtvm, has been rebuilt into a panel-mounted instrument. He replaced the slide switch with a toggle switch, added a fuse holder, a pilot light, five-way binding posts and an improved type dc connector. This instrument is now the equal of any industrial type meter made.

There is another angle to remember in the kit business. Many times medium-quality parts are used because the kit must be designed to sell for a certain price. In lower-priced kits there are often no fuses or pilot lights, and the power switches may not be of the best design. If you built your own equipment using war surplus parts you would have a superior piece of equipment, since the government used the finest, most expensive parts available.

You can see there is a lot to be said on both sides of the question. If you are simply interested in having a piece of test equipment or an amplifier and don't get any special kick out of construction, a kit is for you every time. You will have less trouble and better results.

If, on the other hand, you are a designer at heart, get more kick out of building the instrument than in using it, and have had to modify the kits you have built to satisfy your requirements, kits are not for you. You would simply be bored with the work of assembling them, and not fully satisfied with them after they were built.

But if you find yourself somewhere between these two groups, these general rules may help you:

1. If you have no accumulation of parts, by all means buy a kit.
2. If the most important part of the instruments is a calibrated meter or frequency dial, buy a kit.
3. If the new parts you need, in addition to what you already have, cost more than the kit, then buy the kit.
4. If the instrument you want has no dial or meter, then you should build it from scratch.
5. If you have all the necessary parts on hand, then you should build the device from scratch.
6. If you need a piece of equipment that isn't available in kit form then you have no choice, you must plan and build it.

Many experimenters who are new at our hobby will find new joy and satisfaction from building some electronic project up from scratch. They will develop new skills as well as a deep down feeling of fulfillment in a project that they carried through from design to finished product. END



"Oh, no, I wouldn't dream of tampering with our set!"

RADIO-ELECTRONICS

RCA training at home can be the smartest investment you ever made

Look what you get in the Course in Radio and Electronic Fundamentals

40 Fascinating THEORY LESSONS



Containing all the basic principles of radio and electronics in easy-to-understand form.

40 EXPERIMENT LESSONS



Each containing absorbing, practical experiments bound together in 20 books.

40 SERVICE PRACTICES



Full of practical, time-saving and money-saving servicing tips, bound into 20 books.

PLUS ALL THIS AT NO EXTRA COST...

15 KITS

to build a Multimeter, AM Receiver and Signal Generator. Kits contain new parts for experiments, integrated so as to demonstrate what you learn in the lessons and to help you develop technical skills. Each kit is fun to put together!

MULTIMETER



A sensitive precision measuring instrument you *build* and *use* on the job. Big 4½" meter with 50 micro-amp meter movement. 20,000 ohms-per-volt sensitivity d-c, 6,667 a-c.

AM RECEIVER



Have the satisfaction of building your own radio receiver with this high-quality 6-tube superheterodyne set. Big 5" speaker, fine tone!

SIGNAL GENERATOR



A "must" for aligning and trouble-shooting receivers. Build it for your own use. 170 KC to 50 MC fundamental frequencies for all radio and TV work.

Also, comprehensive, fully-integrated home study courses in • Television Servicing • Color Television • Automation Electronics • Transistors • Communications Electronics • Computer Programming. Stake out your future in electronics with any one of this wide variety of courses.

Practical work with the very first lesson! Pay-only-as-you-learn! No long-term contracts to sign! No monthly installments required. Pay only for one study group at a time, if and when you order it!

SEND FOR FREE HOME STUDY CATALOG TODAY!

RESIDENT SCHOOL COURSES in Los Angeles and New York City offer comprehensive training in Television and Electronics. Day and Evening classes. Free Placement Service. Catalog free on request.



RCA INSTITUTES, INC.
A Service of Radio Corporation of America • 350 W. 4th St., New York 14, N. Y. • 610 S. Main St., Los Angeles 14, Calif.

RCA INSTITUTES, INC. Home Study School, Dept. RE-52

A Service of Radio Corporation of America
350 West Fourth Street, New York 14, N. Y.

Without obligation, rush me the FREE 64-page illustrated booklet "Your Career in Electronics" describing your electronic home study training program. No salesman will call.

Name.....

Address.....

City..... Zone..... State.....

Veterans: Enter discharge date.....

CANADIANS—Take advantage of these same RCA courses at no additional cost. No postage, no customs, no delay. Send coupon to: RCA Victor Company, Ltd., 5581 Royalmount Ave., Montreal 9, Quebec.



The Most Trusted Name in Electronics

NEXT MONTH IN Radio-Electronics

BUILD A LOW-NOISE NUVISTOR TV BOOSTER

Now with these two tiny nuvistors you can construct a booster which will give you the same signal-to-noise ratio that in the past you could equal only with very expensive tubes. Not only economical but easy to build and a joy to use.

MORE NEW FM STEREO MULTIPLEX SCHEMATICS

Changes and modifications on original circuits keep coming in. Here's the latest compilation—with full explanations on how the circuits work.

ALL-MASTER INTER- COM IS EASILY BUILT

It's nice to have an intercom around the house! This one's a cinch to make—uses only one, 4-transistor amplifier. It works like a dream—goes into action immediately and uses any number of stations. Costs practically nothing to operate.

THE OSCILLOSCOPE —ITS USES IN INDUSTRY

There are so many things you can do with a 'scope! This absorbing feature uses 30 photos of waveforms to dramatize the large number of tests and techniques. The TV/radio service technician will get as much out of this as the industrial man.

GOLD MAKES BETTER RESISTORS—

"That's gold in them resistors"—literally! The ends of resistors made in the new Western Electric automatic resistor plant are coated with the precious metal before the end caps are put on. Why, how, and the advantages of doing things that way make a fascinating article.

You'll find a mine of other precious reading in the scores of other articles and departments in the JUNE issue of



ON SALE MAY 22

EQUIPMENT REPORT



This 3½ x 1½-inch instrument is a complete transmitting station.

tool box SIGNAL INJECTOR

Pulse generator supplies signals over wide range.

By HENRY LEVINE*

THIS LITTLE UNIT IS A COMPACT, RUGGED, battery-operated, all-transistor variable signal generator covering 50 cycles to 3.3 mc. Its output voltage is continuously variable from zero to 9 volts, peak-to-peak. This is enough to drive a speaker's voice coil directly, making the unit useful when troubleshooting transistor radios, amplifiers, tape recorders, TV, etc.

The Genie's frequency range is in two overlapping bands (fundamental square-wave pulses). The low band runs from about 47 to 3,300 cycles; the high band from 1,000 cycles to 3.33 mc. Its output consists of very short duration pulses having an excellent flat top and extremely short rise and fall times. Harmonics go well above TV channel 13, thus permitting direct injection into vhf TV tuners.

How it works

When the power switch is turned on (see Fig. 1), the current flows momentarily through R4 from V2's collector. The drop across R4 causes a positive pulse through C2 (or C1 and C2) to be applied to the base of V1. The positive pulse on V1's base creates a

greatly amplified collector current, which flows through R1 into the base circuit of V2, causing the collector current of V2 to continue to rise. This ac-

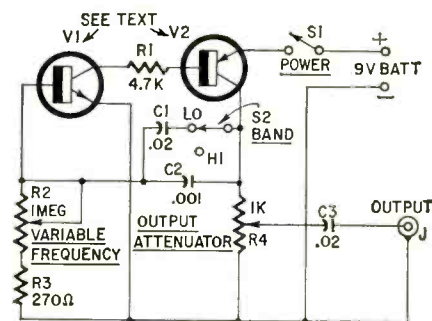

- R1—4,700 ohms
 - R2—1 meg pot, special audio taper
 - R3—270 ohms
 - R4—1,000 ohm pot, linear
 - C1—.02 ceramic
 - C2—.001 ceramic
 - C3—.02 ceramic, 600 volts
 - J—phono output jack
 - S1—on-off switch
 - S2—bandswitch
 - BATT—9 volts, mercury type.
 - V1, V2—Transistors—1 n-p-n, 1 p-n-p.
- Several types have been used. Almost any low-cost transistors with the requisite frequency range and polarity will work well here. Miscellaneous knobs, panels, hardware, case, etc. (The Genie is also available in wired form from Metrex 519 Hendrix St., Brooklyn 7, N.Y.)

Fig. 1—Generator uses a p-n-p and n-p-n transistor.

*Electronics field engineer.

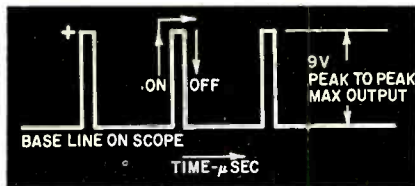

Fig. 2—The Genie output waveform.

tion is so rapid (millimicroseconds) that V2 is brought into saturation abruptly, causing a flat-top pulse.

Now there is no increase in the voltage drop across R4, V1's current drops, and an abrupt negative fall in V2 collector current causes V1 to go sharply into nonconduction and thereby cut V2 off. R1 (4,700 ohms) limits the maximum base current of V2 for a maximum collector current of 9 ma, the saturation point of V2.

C1 and C2 are chosen to permit R2 (a special-taper 1-megohm potentiometer) and R3 (about 270 ohms) to tune over the band of frequencies or pulse repetition rate.

A pulse of this type can readily shock-excite an inductance or tuned L-C circuit at its own natural resonance frequency, causing a series of damped sinusoidal waves, modulated by the repetition rate of these pulses. (Fundamentals are 50 cycles to 3.33 mc.)

A 600-volt blocking capacitor protects the instrument and the equipment being worked on. Battery life of the portable tester is equal to shelf life or about 1 year.

Four controls are available to the technician using the Genie. An ON-OFF switch (its function is obvious); an OUTPUT ATTENUATOR which varies signal strength from zero to full output; a VARIABLE FREQUENCY control which varies the frequency over the range selected with the HI-LO band switch.

As the unit uses only transistors, there is no warmup period, and no hum is introduced into the circuits being tested as a pure dc (battery) supply powers the unit. Fig. 2 shows the output waveform of the tester as seen on a scope with excellent high-frequency and square-wave response.

Now let's try some actual servicing procedures which will demonstrate how the Genie is used and what the technician can do with one.

Amplifiers, PA, hi-fi and intercoms

Complaint: Low gain or dead amplifier. B-plus is OK.

Test procedure: 1. Warm up the amplifier and turn on your Genie. Flip the bandswitch to HI and turn the VARIABLE FREQUENCY control completely counterclockwise (approximately 1,000 cycles). Turn the OUTPUT ATTENUATOR fully clockwise and clip an output cable across the woofer speaker's voice-coil lead points A in Fig. 3. If the speaker is good you'll hear a tone. No tone means an open voice coil.

Now turn the output control all the way down and clip leads to points B. Increase the output. If the output transformer is good, you will hear the tone again. Without changing the output

control setting, apply the generator to point C. The tone should be louder. Go back to D. If the tone weakens, suspect the coupling capacitor.

In this way, checking back through H, it is possible to check almost every component in the amplifier as fast as you can clip and unclip the leads. An especially interesting test is at I. Any strong response here indicates a low-capacitance cathode capacitor.

If you can check back to the source (microphone cable, phonograph or tape input, shorts or opens in the cable can be picked up quickly.

Transistor radios

After checking all voltages with a voltmeter, inject a 1,000-cycle signal into the voice-coil terminals, as if checking an amplifier. Then go back through the audio section, remembering to *keep the signal down* so as not to overload the transistors. Your strongest signal level is needed for voice-coil testing only.

Check the volume control at points A and A1 (Fig. 4). Vary the volume control, noting its action.

Shift the BAND switch to HI and inject a signal between point B and ground. Adjust the VARIABLE FREQUENCY control for loudest signal. Go back through C, D and F, watching for a signal increase as you move from the collector to the base of the transistor. Point E checks the emitter bypass capacitor. If you get a strong signal, the capacitor is open. Inject a signal into G to see if the oscillator transformer is open or shorted or if the tuning capacitors are shorted.

Continue back toward the antenna, clipping the Genie from point H to ground to see if the signal is being passed on to the if circuits. It may be useful to vary the frequency again for

best output. Point I checks overall if gain and also the input of the converter transistor. The rod antenna may be found useful when checking rf stages.

Aligning the rf stages

First adjust the oscillator trimmer to bring in a broadcast station near 1600 kc at the correct point on the dial. Now turn the dial to a clear spot on the high end of the dial (between 1400 and 1600 kc). Loosely couple the Genie output to the antenna coil or lead, selecting a signal of approximately 1000 kc on the high band. Adjust the rf and antenna trimmers, keeping the Genie output low so as not to activate the avc circuits of the receiver.

To adjust the oscillator padder (usually the core of the rf coil), turn the receiver to the low end (600 to 620 kc) and inject a weak signal by radiation from the rod antenna. Adjust the padder for maximum output, again being careful to keep the signal low. Re-check at the high end after the padder adjustment.

To check video circuits

Inject a strong signal into the kinescope input circuit (grid or cathode). Select a frequency from 1,000 cycles down. If the input to the picture tube is OK, bars will be seen sharply on the screen. Adjust the Genie frequency till a convenient number appears. Then work back as in an audio amplifier, watching for any sudden falling off of signal or failure to increase in gain when moving from one stage to another.

(By varying the frequency of the Genie, you can lock in the vertical or horizontal circuits for a rough sync circuit check.)

Troubleshooting tape recorders

The amplifier of a tape recorder is checked as described for audio ampli-

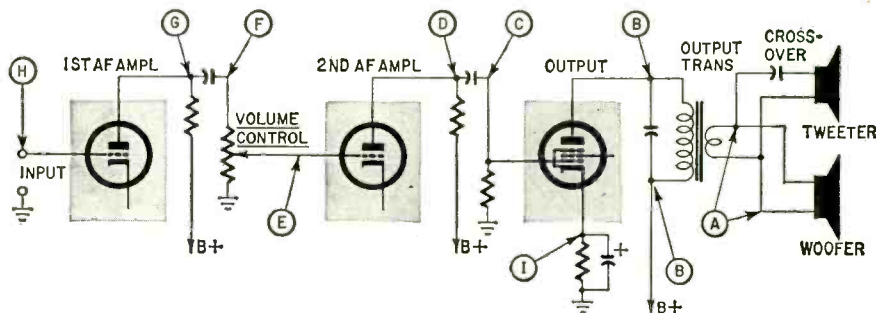

Fig. 3—How the audio end is checked through.

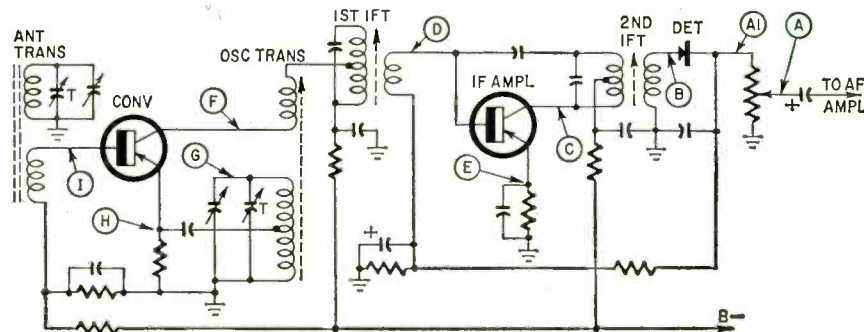

Fig. 4—Check points for a transistor radio.



It's an emergency!

I'm out of **Centralab**
Ceramic Capacitors!

There's no need to fly off the handle when you need a ceramic capacitor. Just taxi down the field to your nearest CENTRALAB distributor. He has the unit you need—whether it's plane or fancy.



CENTRALAB piloted the ceramic capacitor to its present importance in electronics, and today is flying high with the most complete line of discs, tubulars, buffers, trimmers, feed-thrus—for every standard or special application . . . and if you use CENTRALAB's handy capacitor kits you'll never be grounded by lack of parts.

You'll not only like CENTRALAB's complete selection of ceramic capacitors. You'll like the product quality—and you'll like the brand-new plastic box. Travel first class with CENTRALAB ceramic capacitors—in stock at your distributor.

Centralab

THE ELECTRONICS DIVISION OF GLOBE-UNION INC.
922E EAST KEEFE AVENUE • MILWAUKEE 1, WISCONSIN
In Canada: Centralab Canada Ltd., P.O. Box 400, Ajax, Ontario
D-6211S

ELECTRONIC SWITCHES • VARIABLE RESISTORS • CERAMIC CAPACITORS
PACKAGED ELECTRONIC CIRCUITS • ENGINEERED CERAMICS

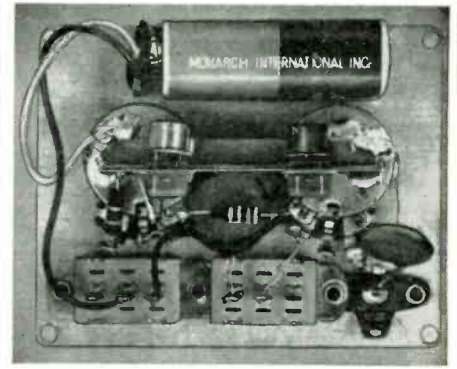

Inside view of Metrix Genie.

fiers. To check the head, make a small induction coil by winding about 50 turns of fine wire (No. 30 or smaller) on a dowel or old alignment tool with a diameter of 1/4 inch or less. Leave leads about 12 or 18 inches long, solder them to an RCA type plug and plug into the Genie. Now you can couple a signal into the head by induction, as indicated in Fig. 5. Bring the coil as close to the front of the playback head as possible. If a loud tone is heard, the head is good. No sound or weak sound might indicate a defective coil in the head, broken leads or improper connections.

Other tests

The Genie has a large number of uses. Hooked up to the input of an amplifier, it can, for example, check the speakers for rattles. Simply rotate the frequency control slowly. If the speaker tends to rattle at any point, the rattle will be heard as the Genie is tuned past that frequency.

A rough square-wave test may be made by setting the Genie to produce a square wave on the scope, with scope vertical amplification at its greatest. Now turn the scope amplification down, attach the amplifier output to the vertical terminals, and apply the square wave to the amplifier input. Compare the amplifier output with the original square wave as seen on the scope.

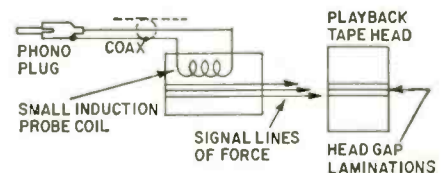

Fig. 5—Checking a playback head.

Faulty shielding or internal breaks in cables may be discovered by using them as input cables to an amplifier, then sliding the Genie rod antenna along the outside of the cable with the Genie output at maximum. As the rod is slid toward the amplifier, a sudden increase in signal indicates the point of poor shielding or the break.

Various other uses will occur to the technician. The Genie has been used for a large number of checks and tests, even including (with the help of a scope) if transformer testing. Whenever a signal ranging from low audio to high rf is needed, the Genie will do the job.

END

The Marvelous Automatic Tube Bopper

I GO OUT ON THIS CALL AND THE lady starts talking. "This is a real good set. It's got written circuits."

"Written circuits?" I asked.

"Of course," she said, "the ones before printed circuits."

"Oh," I said.

"You don't seem to know much about TV sets," she said. "Do you think you can fix this one?"

"I'll try," I replied.

I checked the set and told the lady, "You have an open cathode."

She seemed highly insulted until I made it clear that I was not referring to her clothing or anatomy.

"Look," I pointed out. "When the picture gets dark, I can hit the neck of the picture tube and it gets bright again. You have an open cathode . . . in your picture tube," I hastened to add. "I can try to weld it closed but you might need a new picture tube."

This turned out to be stubborn one that wouldn't weld. "You need a new picture tube," I told her.

"I don't want a new picture tube. Just leave the back off and I'll hit the tube every time it gets dark."

"I can't do that," I said. "You go sticking your hand back in there and you'll light up like a pinball machine."

"Well, I can't afford a new picture tube. Can't you fix it without one?"

"No new picture tube?" I asked.

"No new picture tube!"

"Well, I'll see what I can do."

Reaching into my handy tube caddy, I pulled out a photoelectric cell, a relay and a solenoid which I just happened to have with me. I mounted the photocell in front of the picture tube and the solenoid on its neck and hooked up the circuit (see diagram). I set the

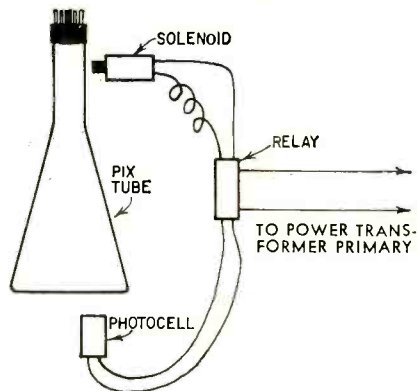

cell so that when the picture got dark, the photocell activated the relay and the relay closed the circuit that caused the plunger of the solenoid to shoot out and bop the neck of the picture tube, making the picture bright again.

"There you are, lady," I said. "It works without a new picture tube."

"Well, I must say you really know your TV repairing," she purred.

I think I'll apply for a patent.—
David W. Cram

MAY, 1962

IT'S EFFORTLESS STEREO WITH THE dynatuner

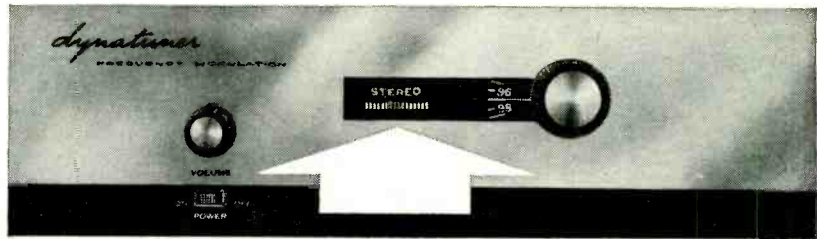

multiplex

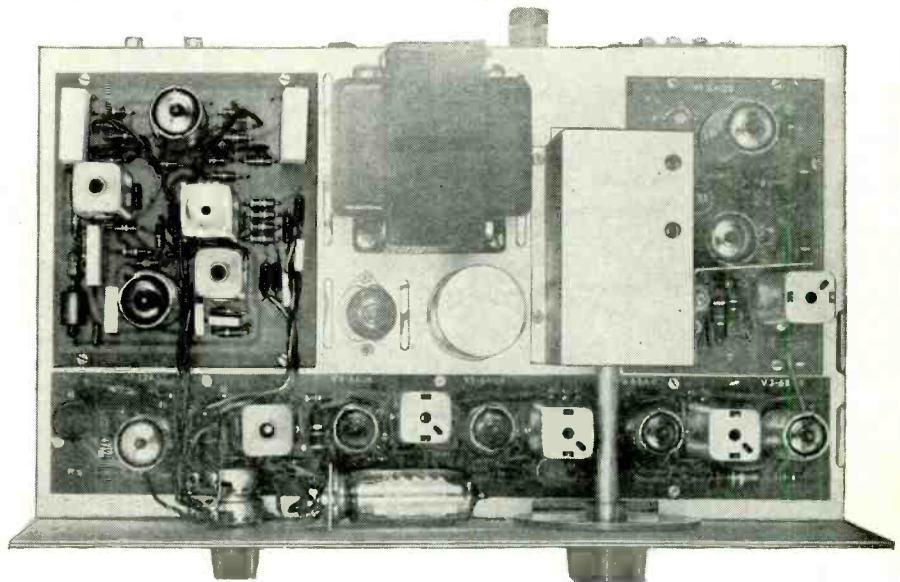

FMX-3 integrator kit \$29.95

FM-1 tuner kit \$79.95

Factory Wired multiplex tuner \$169.90

integrator

(PATENT PENDING)

It takes a little longer to make a good thing better, and the long-awaited Dynatuner FMX-3 is proof that multiplex stereo reception is as simple as mono. Hidden within the Dynatuner chassis, it performs every stereo function automatically without need for switching or adjusting.

The integrator does not detract from the inherently superior performance characteristics of the Dynatuner. The effective sensitivity, noise level, and low distortion are virtually unchanged. The Dynatuner's exclusive reference-grid tuning eye is coupled with Dyna's

unique STEREOBEAM (you know when it's stereo because it says so). Exact adjustment, for stereo and mono, can be done at any time without need for test equipment—thus insuring minimum distortion at all times.

And Dynakit has thought of everything: there are no problems with tape recording off-the-air; mono broadcasts come through both low impedance outputs at the same level as stereo; front panel volume control adjusts both channels; silent, all-electronic switching; no increase in interstation noise; and best of all, its modest cost.

Slightly higher in the West.

Write for detailed information on this and other Dynakits.

DYNACO, INC., 3912 Powelton Avenue, Philadelphia 4, Penna.
CABLE ADDRESS: DYNACO, PHILA.

LEARN

electronics theory this easy way.
No previous technical knowledge required.

BUILD

the finest professional quality TV Set
on a practical "pay-as-you-wire" plan.

SAVE

up to 1/2 on cost of equivalent
educational course plus TV set.

Build the Transvision "Professional" TV Kit described below and get this complete course of study for \$7.95 (available only to Transvision Kit builders.)

Requires no previous technical knowledge. Prepared by experts in teaching novices about electronics.

YOU LEARN: About block diagrams... How to read and follow electronic circuits... How to use basic measuring instruments... Theory and operation of basic electronic circuits... How to service TV, Radio, and other types of electronic equipment.

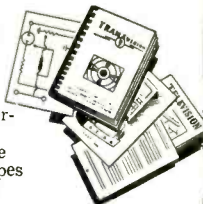

Prices range from \$119 to \$199.

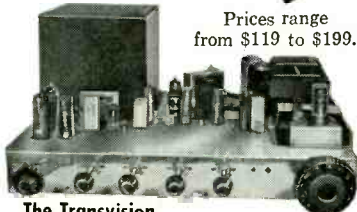

The Transvision "Professional" TV Kit

Choice of 19", 23", or 27" Picture Tube... Easy "Pay as You Wire" Terms... Only \$15 for the Starting Package.



A few of the Professional Quality Features of Transvision TV Kits:

Choice of push-pull 10-watt audio or output to your Hi-Fi System... D.C. restoration... Ultra-linear sweep circuits... Standard Coil Model PKO Automatic Tuner... Super-sensitivity for fringe areas... Complete line of Accessories for Custom Installations.

U. S. Armed Services and over 4000 schools and colleges have selected Transvision Receivers for educational television.

ASSEMBLY MANUAL—\$2.00

See how easy it is to assemble the Transvision Kit. Cost of Manual refunded on purchase of Kit.

TRANSVISION New Rochelle, N.Y. NE 6-6000

START NOW — MAIL THIS COUPON.

- TRANSVISION Electronics, Inc., New Rochelle, N.Y. Dept. RE-L-5
- Send FREE 12-page Catalog... I enclose \$2 for Assembly Manual, refundable on purchase of Kit.
- I enclose \$15 for Starting Pkg. on pay-as-you-wire plan. (Complete Kits range from \$119 to \$199.)

Name _____
Address _____
City _____ Zone _____ State _____

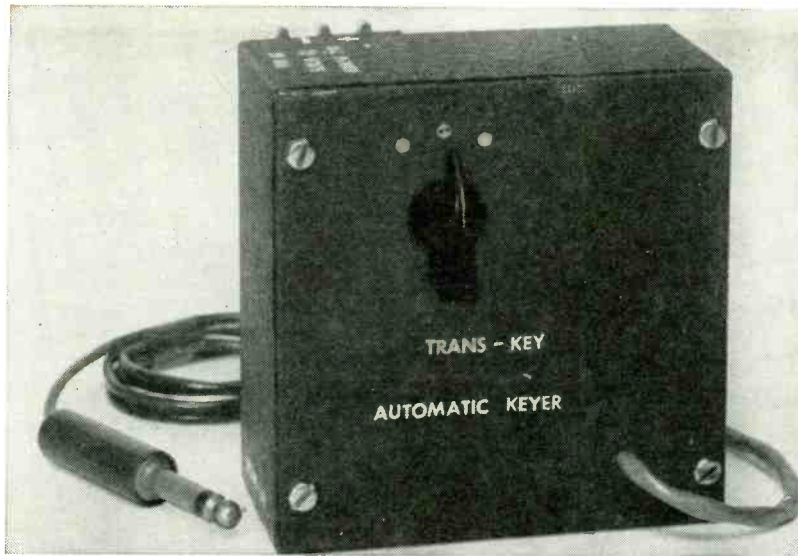

Cable at right goes to key. Cable at left of Trans-Key plugs into transmitter.

ELECTRONIC KEY

By
DAVE STONE

THE Trans-Key is a transistorized electronic key which will do much to provide perfect code transmission for hams. A light, compact and low-power unit, it is suitable for portable and mobile as well as fixed-station use. The speed and duration of the dots and dashes are selected with a single control. Power requirements are a modest 12 volts at 10 to 20 ma (higher current drain on the higher-speed ranges). Power can be supplied in a variety of ways—dry cells, car battery or low-voltage power supply.

Circuitry

Each transistor is connected as an on-off switch to furnish current to a sensitive relay in the collector circuit. When the key lever is pushed to the left for a dash and released, capacitor C1 is temporarily connected to the

negative battery return. C1 charges very rapidly and, at the same time, V1 conducts. V1's collector current flow energizes the sensitive relay. One set of contacts completes the keying circuit in the transmitter, while the other disconnects the center arm of the key from the negative return. The dashes (or dots) are self-completing as a result, and cannot be altered or stopped by further action with the key lever until the transistor switching circuit completes its action.

V1 continues to conduct as long as C1's charge furnishes bias current to the base. The charge leaks off at a rate determined by the values of timing resistors R1 through 4 and eventually drops low enough to cut off the transistor (and release the keying relay).

The same action takes place with V2

- R1—5-pot, 5,000 ohms, linear taper
R2—2,200 ohms
R3—3,900 ohms
R4—6,800 ohms
R6—820 ohms
R7—2,000 ohms, 5% (or two 1,000 ohm resistors in series)
R8—3,000 ohms, 5%
R9—2,200 ohms, if needed
All resistors 1/2 watt 10% unless noted
C1—2-25 μ f, 10 volts, tantalum
V1, 2-2N223 or 2N109
RY—5,000-ohm plate-circuit relay (see text)
S1—2-pole 3-position rotary switch (shorting or nonshorting)
Modified speed key, see text
Cable, 3 wires, for key
Metal box, 4 x 4 x 2 inches (Bud C-1793 or equivalent)
12-volt dc power source
Plug to fit transmitter jack (and cable)
Sockets for V1, 2

Trans-Key schematic. Use R9 when dashes can't be made long enough with R1.

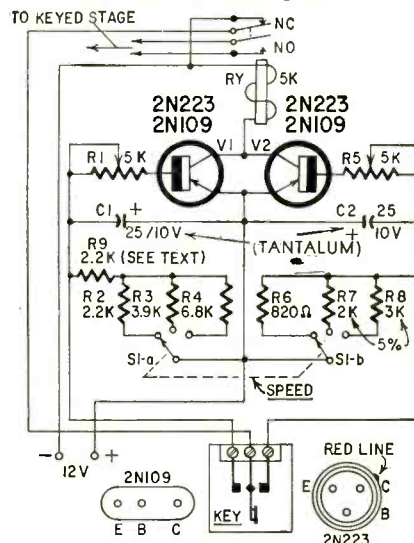

BENCH

Two transistors
Three ranges—8, 12 and 15 words per minute (with given resistor values)
Draws only 20 ma at 12 volts dc



The keyer works well, dots and dashes are clean-cut and accurate. Dashes seem to be a bit short when compared with dot length, but adding R9 corrects that.

TESTED

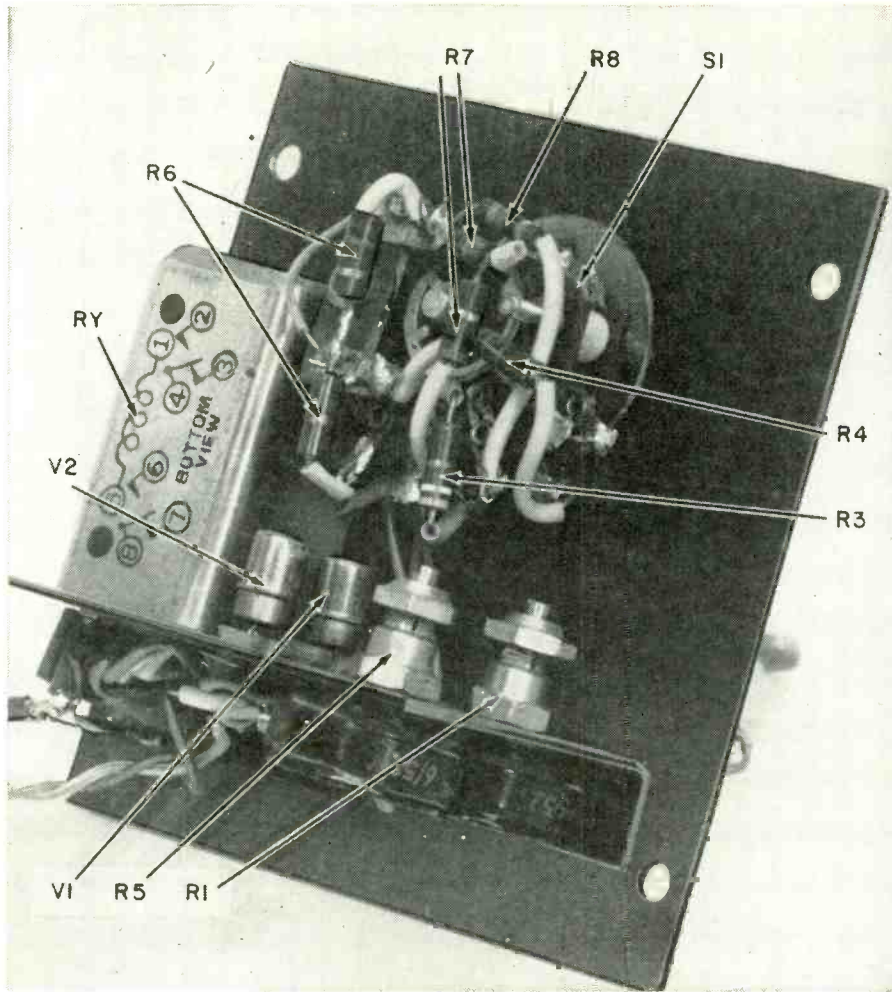

Interior of Trans-Key.

when the key lever is pushed to the right. V2 conducts approximately a third as long as V1 due to the lower values of R6 through 8. With the timing resistors shown, the speed ranges are approximately 8, 12 and 15 words per minute.

Construction

The layout and construction of the Trans-Key are not at all critical. My unit is built into a 4 x 4 x 2-inch utility box with attached shelf, and all components fit comfortably. The SPEED switch (S1) is mounted on the front panel. Two cables run from the back of the cabinet to connect to a modified speed key and the transmitter's keyed circuit. The speed key was modified to provide separate contacts on each side of the key lever, and a separate binding post was added to the key's base for the third connection. If you desire, a home-made key made from a strip of spring steel and a few pieces of hardware will do the job as well.

Most parts are readily available from the surplus-parts box. The relay was obtained from military surplus gear. Almost any sensitive type (1 to 3 ma at 5,000 to 8,000 ohms) can be used, if it has the required contacts—double-pole single-throw with one pair of contacts normally open and the other pair normally closed. I used a dpdt type with one set of contacts for the normally

open pair and the other connected normally closed.

R6 and R7 are actually two resistors in series because they were readily available, but they can be replaced by single resistors of 820 and 2,000 (5%) ohms, respectively. R9 is needed only if dashes cannot be made long enough with R1.

If other speeds are desired, increase the number of switch contacts and resistance combinations. The ratio of V1's to V2's timing resistors should be approximately 2½ to 1.

Adjustments

After construction, connect the keying leads to a tone generator or a code-practice oscillator. Rotate S1 to the highest speed range and tap the key to produce dots and dashes. Listen to the duration of each and adjust R1 and R5 to get the proper time ratio. The dash should be approximately three times longer than the dot. Check these settings on the other two ranges and readjust if necessary. This is all that is necessary.

The relay's keying contacts can be used to key an oscillator or buffer stage in the transmitter as long as the contact ratings are not exceeded. The Trans-Key can also be used to key an audio generator in an alarm calling system as interrupted tones demand quicker attention. A compact code oscillator can be built in with the keying circuit in one enclosure. **END**

ARE YOU
GETTING
THE MOST
VALUE FROM
YOUR MEAS-
UREMENT
DOLLAR? ...

Compare all
features and you'll agree,

BEST BUY IS EMC!



EMC'S NEW
MODEL 212
TRANSISTOR
ANALYZER ...
Checks DC
current gain in
3 ranges to 200.
Tests for leak-
age. Checks all
transistors as

oscillators both in and out of circuit. Can be used to signal trace AF, IF or RF circuits. Checks condition of diodes. Tests battery voltage on 0-12 scale. Checks DC current drain on 0-80 ma scale. Supplied with complete instruction manual, transistor listing and pair of test leads.

Model 212 **\$18.50 Wired**
Model 212 Kit **\$13.50**



EMC'S NEW
MODEL 213
TUBE
TESTER ...
Completely
modern! Com-
pletely flexible!
Completely new!
Checks all the
new 12 prong
(Compactron),

Nuvistor, Novar, and 10 prong tubes, in addition to octal, locial, miniature, and 9 prong tubes. Tests each tube for shorts, leakages, intermittents, opens, as well as for quality. Each section of multi-purpose tube is checked separately. Magic eye, Voltage Regulator and HI-FI tubes are also tested. Unique switching arrangement makes the checker obsolescent proof. Supplementary tube listings supplied periodically at no cost to keep instrument up to date. It comes complete with instructions and tube charts in ring bound manual.

Model 213 (in bakelite case with strap)
\$28.50 Wired Model 213 Kit **\$18.90**

Model 213P (in wood carrying case)
\$32.25 Wired Model 213P Kit **\$21.90**

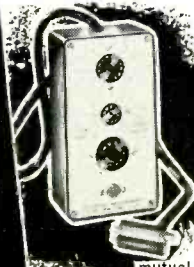

EMC'S NEW
MODEL SA
SOCKET
ADAPTOR ...
Enables user
to check 12 pin
Compactron,
Nuvistor,
Novar and
10 pin tubes
with any type
tube tester
including
mutual conductance type,

Model SA **\$9.45 Wired**
Model SA Kit **\$4.95**

Yes, tell me more, send me **FREE** a detailed catalog of the Complete EMC Line. Dept. RE-562

NAME
STREET
CITY STATE

EMC Electronic Measurements Corp.
625 B'way, New York 12, N. Y.
Ex. Dept., Pan-Mar Corp., 1270 B'way, New York 1, N. Y.

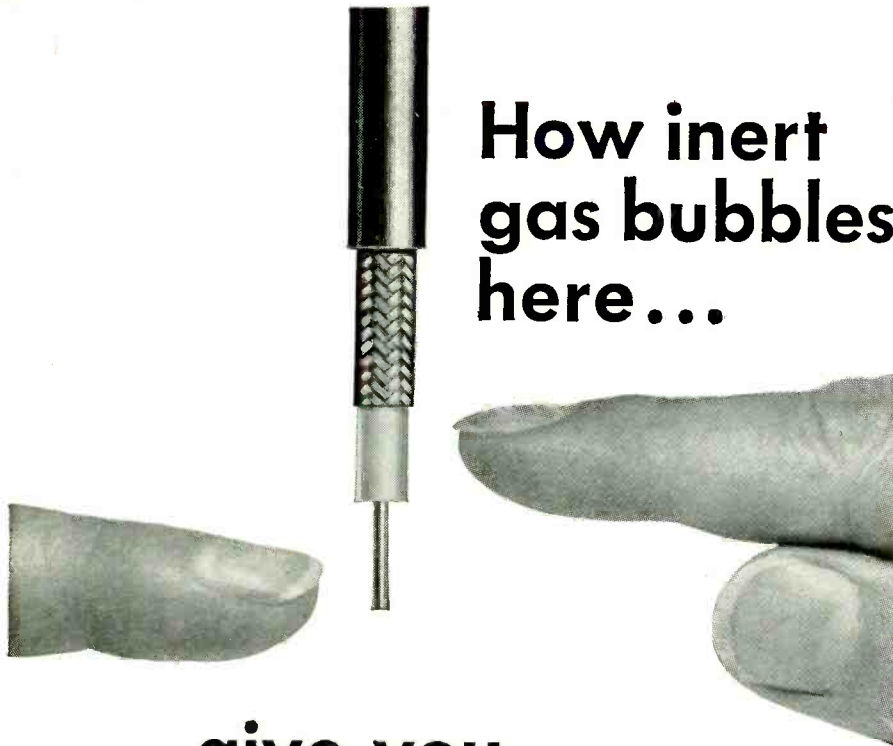

How inert
gas bubbles
here...

...give you
up to 35% greater
signal strength
here

When you use Amphenol Polyfoam® coaxial cable, you consistently increase signal strength up to 35% over ordinarily used RG-/U cable. The secret? It's in the new Polyfoam dielectric material—a cellular polyethylene that uses inert gas as the expanding agent to form tiny, completely enclosed cells in the polyethylene. It gives you a dielectric constant of 1.50 as compared with 2.26 for solid polyethylene—for lower attenuation and minimum capacitance.

That's not all! With Polyfoam cable, you still utilize minimum diameters. Matter of fact, Polyfoam cable actually weighs less than standard RG cables.

You're ahead all these ways—and at surprisingly low additional cost—when you use genuine Amphenol Polyfoam for your coaxial cable requirements. See your authorized Amphenol Distributor. If you don't know who he is, write to Amphenol Distributor Division, 2875 S. 25th Avenue, Broadview, Illinois, or call Columbus 1-2020.

AMPHENOL Distributor Division / Amphenol-Borg Electronics Corporation

Industrial Electronics Dictionary

*from ultrasonics to
X-ray tube*

(concluding installment)

By **ED BUKSTEIN**

Ultrasonics: High-frequency vibrations above the range of human hearing. Ultrasonic generators usually employ a crystal transducer—the crystal transfers its vibrations into the surrounding medium—air, liquid, metal, etc. The magnetostrictive oscillator is sometimes used to generate ultrasonic vibrations. In this type, a metal bar inside an oscillator coil becomes alternately longer and shorter as the magnetic field alternates, transmitting vibrations into the surrounding medium.

Ultrasonic vibrations are used industrially for cleaning and "drilling" metals, for mixing liquids and for detecting internal flaws in metal structures by the echo detection (radar) method.

X-rays: A form of electromagnetic radiation of extremely short wavelength. The X-ray spectrum extends from approximately .06 to 120 Angstroms (an Angstrom is ten-billionth of a meter). X-rays are useful industrially because of their penetrating power, their ability to excite a fluorescent screen and their ability to expose a photographic film. (See Fluoroscopy and Radiography.)

X-ray tube: A tube specifically designed for producing X-rays. Electrons emitted from the tungsten filament of the tube are attracted to the target, a tungsten insert in the copper anode. The target is operated at a high potential with respect to the filament, typically about 100,000 volts. When the high-speed electrons from the filament strike the target, some of their energy is converted to X-radiation. Most of the energy, however, is converted to heat, and some means of cooling the anode must be provided. Water and oil cooling are commonly used in addition to cooling fins mounted on a copper rod extending from the anode. Some tubes use a motor-driven anode so that electrons do not continually strike the same point on the target surface.

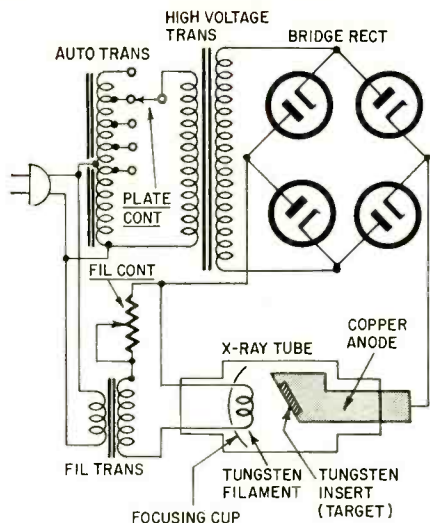
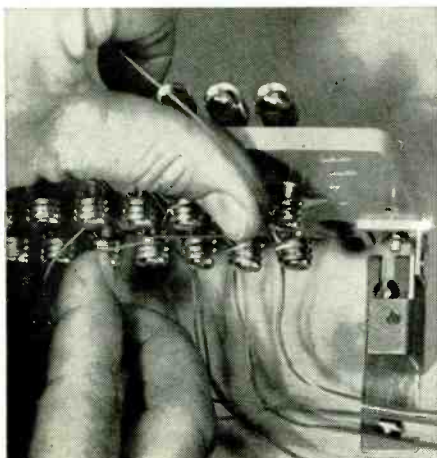

Fig. 29—X-ray circuit consists basically of high-voltage supply for anode of X-ray tube, filament supply and associated controls.

As shown in Fig. 29, the associated circuitry consists basically of a high-voltage supply, a filament supply and controls for varying anode voltage and filament current. At higher values of anode voltage, X-rays of shorter wavelength are produced. These are more penetrating and are known as *hard-X-rays*. Anode voltage is controlled indirectly by varying the input to the primary of the high voltage transformer. A rheostat in the filament circuit permits control of filament temperature and consequently of the quantity of X-rays produced. END

Coil-Spring Connectors

These coil-spring connectors replace binding posts in telephone blocks. When a wire is forced between two turns of the coil, the sharp square edges of the wire cut through the insulation and make a good electrical connection. Developed by Bell Telephone Labs, the connectors are expected to cut connecting time in half as compared with connections made to binding posts.



BUY A DOZEN VU-BRITES



get the clip board
FREE!

Attractive wood-grained Masonite clip board—just the right size for holding your service order book, or for dozens of other uses in shop or home—yours free with the purchase of 12-Vu-Brites!

WHAT A DEAL!

For a limited time, Perma-Power is offering you this wonderful gift *absolutely free* with the purchase of 12 Vu-Brites at the regular price. Vu-Brites are the brighteners that really do a job—on series or parallel sets (Model C401 for parallel; Model C402 for series). They come colorfully packaged in individual boxes . . . and are priced at \$9.95 the dozen, net.

Hurry—this special gift offer will end when current stocks are gone. Call your distributor today.

Perma-Power COMPANY

3106 N. ELSTON AVENUE • CHICAGO 18, ILLINOIS

TV Tuner Problems?

Simply send us your defective tuner complete: include tubes, shield cover and any damaged parts with model number and complaint.

Send for details and FREE Mailing Kit

CASTLE TV TUNER SERVICE, INC.

5715 NORTH WESTERN AVENUE, CHICAGO 45, ILLINOIS
653 PALISADE BLVD., CLIFFSIDE PARK, NEW JERSEY
IN CANADA: 136 MAIN STREET, TORONTO 13, ONTARIO

Castle  Overhaul

ALL MAKES
ONE PRICE

90 Day
Warranty **9.95**

Tubes and Major Parts: Extra

NOW! A down-to-earth guide to MODERN TEST PROCEDURES

Alternate Test Methods • Cautions • Correct Instrument Usage • Readings • Connections and Control Settings • Test Techniques • Time-Saving Methods ... and all the rest!

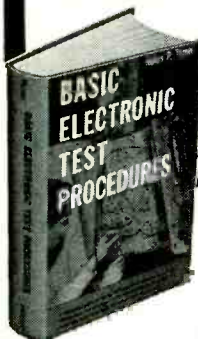

Almost anyone can repair TV's, radios and other electronic equipment AFTER the trouble has been located. The trick is to know how to spot troubles in the first place—and that means knowing how to use instruments fast and accurately. Actually, it's amazing what you can do with only a few instruments—providing you know how to use different kinds for the same job; how to select the right ones; where to use them; how to connect them into circuits; how to set controls; how to read them; and how to follow professional test procedures every step of the way. And that's exactly what this new 316-page book with its more than 190 how-to-do-it pictures, procedure sketches and pattern designs teaches you.

IT'S WHAT YOU KNOW ABOUT USING INSTRUMENTS THAT COUNTS!

BASIC ELECTRONIC TEST PROCEDURES by Rufus Turner helps you to learn to troubleshoot any circuit, equipment or component in half the usual time. Covers different methods of doing specific jobs. For instance, you learn to check distortion by the 'scope, rejection filter, harmonic-distortion meter, wave analyzer or audio oscillator methods. You learn to make resistance measurements with a current-meter, a volt-ammeter, a volt-meter, an ohmmeter, or via the bridge method... and so on. Subjects include current checks; power, capacitance, inductance, resistance, AF, RF, phase, distortion, and modulation measurements; tube and semi-conductor testing; audio amplifier tests; sensitivity, RF gain, fidelity, AVC voltage, operating voltage checks, etc.; visual alignment techniques—even transmitter and industrial electronic measurement procedures. Price only \$8.50.

CONSIDER OSCILLOSCOPES for instance!

Simplified explanations of modern oscilloscope techniques show how to use your 'scope as a volt-meter, current meter, variable frequency oscillator, etc., or for making RF, phase or AM measurements; for distortion and deflection checking; square wave testing; visual AM and FM alignment and for many other jobs. Every detail is explained—from making connections to analyzing patterns.

INDUSTRIAL ELECTRONIC TESTING, too!

STILL ANOTHER BIG FEATURE is the book's usefulness in acquainting you with industrial electronic test techniques—including testing non-electronic phenomena such as strain, pressure and others. Price only \$8.50.

PRACTICE 10 DAYS... FREE!

Dept. RE-52
Holt, Rinehart and Winston
P.O. Box 2334, Grand Central Station
New York 17, New York 623900

Send **BASIC ELECTRONIC TEST PROCEDURES** (708933) for 10-day FREE EXAMINATION. If I decide to keep book, I will then send you \$8.50 plus postage in full payment. If not, I will return book postpaid and owe you nothing. (SAVE! Send \$8.50 with your order and Rinehart pays the postage. Same 10-day guarantee with your money promptly refunded if you're not more than satisfied with book.)

NAME _____
ADDRESS _____

CITY, ZONE, STATE _____
OUTSIDE U.S.A.—Cash with order only.
Price \$9.00. Money back if book is returned in 10 days.

Offer expires Dec. 31, 1962

ALL-TRANSISTOR MOTOR-CONTROL RELAY

By HOWARD T. BAILEY

Using transistor amplifiers to control reversible shaded-pole motors reduces the size and weight of the control unit, and cuts operating costs. Also, a properly designed transistor unit should improve the reliability of the control system. One such unit is described here.

The control-system principle is the same as that of a vacuum-tube amplifier. The direction of rotation is set by the relative phase of the control signal and field current. Speed is controlled by the magnitude of the input signal.

A transistor amplifier for motor control must provide high gain without phase shift and supply enough power to feed the shading coils of the motor being controlled.

The first requirement can be met by suitable circuit design, while the problem of enough power may be overcome by using high-wattage power transistors.

A typical motor-control circuit is shown in the diagram. It uses four p-n-p transistors and provides a maximum stall torque of .05 lb/in for a 0.62-mv input with a Barber-Colman DYAE continuous-duty motor. The input is an ac signal from a bridge circuit that detects physical conditions in terms of voltage differences.

Circuit action

The input signal from the bridge is applied via C1 to V1's base. V1 is a common-emitter amplifier. R1 provides constant emitter-current bias to help stabilize the stage against current changes caused by temperature variations. This resistor is bypassed by C3 for maximum gain. V1's output is fed to V2, another common-emitter amplifier. R2 provides constant emitter-current bias for temperature stabilization, C4 being a bypass capacitor. A small amount of negative feedback is applied to V1's base from the voltage drop across R3 to improve the operating stability, the gain of the first two stages

being high. C2 and C5 also supply some negative feedback to reduce harmonic distortion in the first and second stages, respectively.

The driver stage, V3, is a power transistor operated as an emitter follower. This stage gives no voltage amplification but provides a large current to drive output stage V4. It also provides correct impedance matching to the output stage. The full negative supply is connected to the collector and the base is biased in a reverse direction by returning it to ground. C6 is a dc blocking capacitor in the feed from V2's collector. The output current from V3's emitter is applied directly to the base of output transistor V4.

The current from V4's collector flows through the shading windings of the reversible motor. A control signal applied to the unit causes an amplified signal voltage to be set up across the shading coils, and the motor then turns in a direction determined by the relative phasing of the signal voltage and the reference voltage in the field winding. The amplitude of the signal voltage decides the speed of the motor in either direction.

Temperature stabilization of V4 is provided by diode D1. This is preferred instead of a resistor in the emitter feed as its stabilizing effect is more constant at various values of emitter current. The larger capacitor, C7, absorbs high-voltage peaks set up across the shading coils at the moment of switching off. Without C7 such peaks could damage the output transistor.

The negative supply for the transistors is obtained by full-wave rectification of a 26.5 center-tapped supply across the secondary of transformer T1.

Many devices can be used as the detecting element of the bridge—temperature-sensitive resistances, light-sensitive cells, humidity-sensitive chemicals, etc. In general, any means of varying a resistance can be used as a detection device if it can be incorporated in a bridge circuit. END

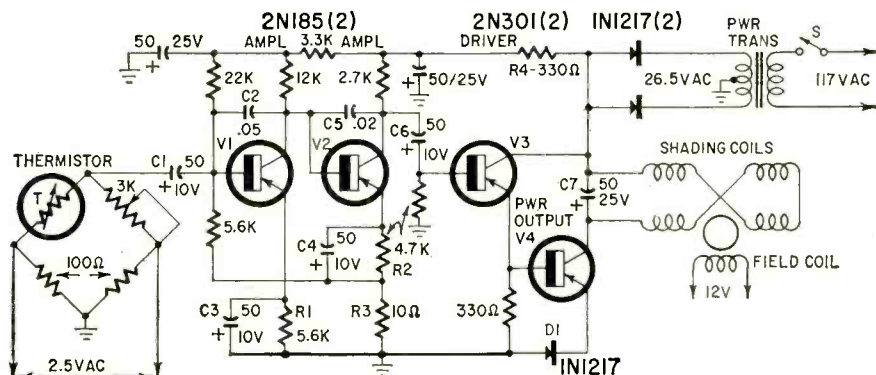

Circuit of the transistorized control device.

NEW PRODUCTS

SUPPRESSIKIT, type SK-1. For radio-frequency interference suppression in CB, amateur, public service and marine radio applications. 5 basic components. Suppression to 400



mc.—Sprague Electric Co., 125 Marshall St., North Adams, Mass.

CB TRANSCEIVER, model 770, 117 vac only. Retractable coiled cord, push-to-talk ceramic-element mike. Input 5 watts on any 4 channels. Variable pi network for matching to



most antennas; mounting bracket permits 360° chassis positioning at 30° intervals. Superhet receiver, continuous tuning over all 23 channels, 1 receiving crystal matched to 1 of 4 transmit crystals. Automatic noise limiter and squelch control. Built to FCC regulations. **Model 771—**117 vac or 6 vdc; **model 772—**117 vac or 12 vdc. —Eico Electronic Instrument Co., Inc., 33-00 Northern Blvd., Long Island City 1, N. Y.

GENERAL COVERAGE RECEIVER, model NC-105. Continuous coverage 550 kc to 30 mc, 4 bands. Peaking Q-multiplier works on CW, AM.



Continuously variable selectivity 500 cycles to 7 kc. Separate product detector/beat-frequency oscillator for CW and SSB. Age and S-meter for all modes. Bandsread calibration charts for amateur and some foreign bands. Separate rf and audio gain controls; built-in 5 in. speaker; front-panel headphone jack; full-wave transformer power supply with rectifier.—National Radio Co., Inc., Dept. P, Melrose 76, Mass.

WALKIE-TALKIE, model CB-901. 9 transistors. Variable-reluctance mike, 2¼-in. PM speaker, fingertip volume control. Weighs 1 lb.

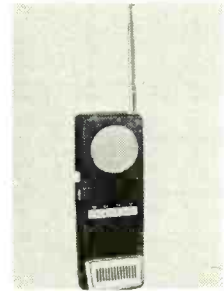

range 6 miles. Powered by 8 penlight cells. Meets class-D specs.—Sony Corp. of America, 514 Broadway, New York 12, N. Y.

FM ANTENNA AMPLIFIER, Range Extender, model FMX. Doubles primary reception of FM tuners and radios. One-tube unit has 20-db minimum gain over entire FM band. Installs

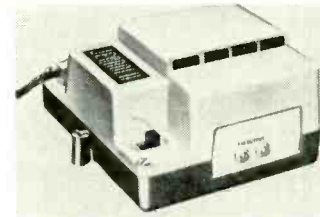

anywhere between antenna and FM tuner or radio; mounted on any flat surface where 117-volt 60-cycle outlet is available. With manufacturer's MF-2 or MF-4 multi-set couplers, FMX can feed signal to 2, 3 or 4 FM receivers, 6DJ8 frame-grid tube, shut-off switch.—Jerrold Electronics Corp., 15th & Lehigh Ave., Philadelphia 32, Pa.

TRANSISTORIZED FM TUNER, model LT-300. Automatic built-in multiplex. Wide-band design, sensitivity 1.8 µv, 20-db quieting; if bandwidth 270 kc. peak-to-peak discriminator

GET IMPROVED CB AUDIO, GREATER RANGE WITH TURNER CB MICROPHONES



MODEL 254C



MODEL 350C

Manufacturers know this — that's why more Turner microphones are used as original equipment on CB than any other. The Turner Model 350C (List \$16.80) for top mobile rig performance; the Model 254C (List \$23.50) ideal for base station operation.

The Turner Combo

Get both matched ceramic microphones in the Turner Combo, available at your Parts Distributor or Citizens' Band headquarters at \$40.30 List.



THE TURNER MICROPHONE COMPANY
933 17th St. NE Cedar Rapids, Iowa

Gentlemen:
Please send me complete information and specifications on the Turner Mobile Model 350C the Turner Base Station Model 254C the Turner Combo.

NAME _____

ADDRESS _____

CITY _____ ZONE _____ STATE _____

THE  MICROPHONE COMPANY

933 17th Street NE, Cedar Rapids, Iowa
In Canada: Tri-Tel Associates, Ltd., 81 Sheppard Ave. West, Willowdale, Ontario



separation 1 mc. Noise level 66 db below 100% modulation. Synchronous-gate separation of channels from composite signal reproduces 20-20,000 cycles ± 1 db. Afc, signal-strength meter, interstation muting. 20 transistors, 9 diodes. Consumes 4 watts.—Lafayette Radio Electronics Corp., 111 Jericho Turnpike, Syosset, N. Y.

MULTIPLEX ADAPTER, ABCO model 650. Attaches to all discriminator-type FM tuners and radios. Tubes: 2-12AU7, 1-6C4, 2 diodes. Input 1-volt rms approximately; output 2.5 volts rms per channel; power 117 volts ac.



Approximately 20-db separation.—A B C Electronics, 440 Boone St., Orlando, Fla.

STEREO MULTIPLEX ADAPTER, model MX-100. 28-db separation, 1.5-volt output, less than 1% third harmonic distortion. Response +1 db, 15 cycles to 15 kc. Tube complement: 1-ECC85, 2-12AX7, 1-6X4, 2-1N541 diodes. Dual inputs, left and right stereo outputs. Power



consumption 117 volts, 30 watts. Built-in noise filter, front-panel separation control or maximum separation adjusted at factory.—PACO, Div. Precision Apparatus Co., Inc., 70-31 84th St., Glen Dale 27, N. Y.

FM STEREO TUNER, model TP50. Flat frequency response to 75,000 cycles; sensitivity 0.9 μ v, 20-db quieting. Agc maintains ± 0.5 -db audio-output level; signal-variation range 10



to 10,000 μ v. Built-in tape recording filter. Hum and noise level: -60 db, 100% modulation.—Bogen-Presto Div., Siegler Corp., PO Box 500, Paramus, N. J.

STEREO PREAMP, model C-11. 3-dimensional illuminated front panel. Response ± 0.5 db, 20-20,000 cycles, distortion less than 0.1% full rated output. 5 high-level stereo inputs for tuners, tape units, auxiliary signal sources and tape monitor. Impedance 250,000 ohms, sensitivity 0.25 volt. 2 phono inputs 2 mv, 47,000 ohms; tape head 2 mv, 1 meg; mike 2.5 mv, 1



meg. Additional mono line for remote amplifier and speaker. Main output 2.5 volts at rated input, tape output 0.25 volt at rated input. 8-position input selector, 7-position mode selector, separate channel controls, stereo balance control, master volume control.—McIntosh Laboratory, Inc., 5 Chambers St., Binghamton, N. Y.

TRANSISTOR STEREO SYSTEM, Astro. AM and FM tuners, FM multiplex, dual preamps, dual amplifiers. 55 watts, response 1 db, 20-20,000 cycles. Harmonic distortion less than 1% at 20 watts. Channel separation 30 db. Headphone receptacle, index-locked balance and



tone controls, source selector, instantaneous signal playback. Loudness contour, channel reverse, phase reverse, rumble filter, afc, AM bandwidth adjustment.—Altec Lansing Corp., 1515 S. Manchester Ave., Anaheim, Calif.

FM STEREO TUNER, Citation III-X. Built-in multiplex adapter. Front panel single control for mono, stereo and stereo SCA filter to eliminate stray noise in multiplex broadcasting of background music. SCA filter defeat for stereo. Sensitivity 0.65 μ v, 20-db quieting. Selectivity: 240-kc bandwidth; 6 db down. Discriminator



peak-to-peak separation 1 mc. Image rejection 65 db; i.f. rejection 90 db. Response ± 0.5 db, 1-52,000 cycles. Distortion unmeasurable at 30% modulation, less than 1% at 100% modulation. Hum 65 db below 100% modulation; output level 2 volts at 100% modulation, adjustable by front-panel control. Adapter: separation -30 db, 10-15,000 cycles; $\pm \frac{1}{2}$ db, 10-15,000 cycles; harmonic distortion less than 1% at 100% modulation; hum and noise -60 db. Kit or factory-wired.—Harman Kardon Inc., Ames Court, Plainview, N. Y.

4-TRACK TAPE RECORDER, Statesman Stereo 4, model 350. Records and plays back stereo. 2 speeds, eight hours recording time on 7-inch reels. Pushbutton controls, automatic tape lifters, constant-speed hysteresis motor, digital tape counter. 2 full-range dynamic mikes, two 4 x 6 oval dynamic speakers, 2 VU meters. Auxiliary inputs and outputs, sound-deflecting baffle wings. Power requirements 85 watts, 110-117 volts ac only, 60 cycles. Tube complement: 2-12AX7, 2-6BMB, 6AR5, 5M150C (selenium



rectifier). Response 50 - 14,000 cycles, 7.5 ips. Flutter and wow 3% at 7.5 ips. Signal-to-noise ratio better than 45 db per channel. Output power 5 watts per channel. Input impedance 500,000 ohms for auxiliary inputs using AM/FM multiplex tuner, stereo record and tape; 50,000 ohms for dynamic mike. High output impedance for external main amplifier connections. External speaker or headphone connections for hooking up to 4- or 8-ohm speakers. Tape, reels, patch cords.—International Products Co., 1289 S. La Brea Ave., Los Angeles 19, Calif.

12-INCH TURNTABLE MAT, model PC-22, to protect record grooves, reduce wow and



flutter. Replaces worn mats, fits over existing one. 3 ridges provide support for 7-, 10- and 12-in. records.—Robins Industries Corp., 36-27 Prince St., Flushing 56, N. Y.

HI-FI ENCLOSURE, Petite. Cone-construction woofer, overhanging voice coil. Woofer matched to tweeter through crossover network



with volume control. Input 8 ohms, power rating 6 watts.—Argos Products Co., 301 Main St., Genoa, Ill.

3-WAY SPEAKER SYSTEM, model S-4. 8-in woofer, separate mid-range and high-frequency drivers. Multiple crossover network with



separate controls for mid-range and tweeter drivers.—H. H. Scott, Inc., Dept. P, 111 Powdermill Rd., Maynard, Mass.

BOOKSHELF SPEAKER SYSTEM. 24 x 10 x 9 inches British speaker. For amplifiers 8 to 50 watts, response 45-16,000 cycles. 3-inch hardened tweeter diffusion cone, 8-inch high com-



pliance woofer with almost $\frac{3}{4}$ -inch cone displacement.—Anglo American Acoustics Ltd., 129 Maryland Ave., Freeport, N. Y.

AUTOMATIC TAPE DECK, companion to Automatic Tape Cartridge. Instantaneous stop and start; automatic cartridge lock; remote-control operation; adaptable for rack mounting;

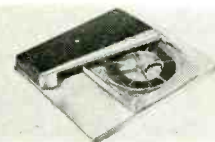

heavy-gauge steel construction. Pressure roller drops away from capstan when not in operation to protect roller. Speed accuracy with 4-pole induction motor, +3%, -2% or better. Multi-belt drive system for 3 speeds. 4-pole shaded-pole induction motor dynamically and statically balanced, shock-mounted, less than 40°C heat rise in continuous operation. Wow and flutter 25% or better, maximum average 3% cycles.—Conley Electronics Corp., 1527 Lyons St., Evanston, Ill.

AUTOMATIC RECORD CHANGER, model UA16. Dynamically balanced motor. Self-lubricating, lifetime bearings, mounted with full rubber suspension. One-piece aluminum die-cast

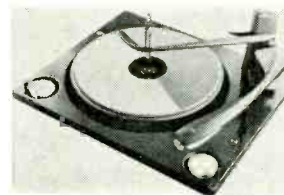

tone arm. Wow 0.2%, flutter .06%, rumble -56 db. 4 speeds, plays all record sizes of same speed intermixed. Concentrically weighted turntable.—BSR (USA) Ltd., 115-10 14th Rd., College Point 56, N. Y.

MINIATURE TAPE RECORDER, Phono Trix Executive 88-B. Battery-operated. Immediate playback through mike while connected to



input jack. Used with manufacturer's desk amplifier, 8S-B, becomes PA system, records and amplifies simultaneously. Pushbutton-operated, top controls.—Matthew Stuart & Co., Inc., 156 5th Ave., New York 10, N. Y.

PORTABLE TAPE RECORDER, model TK-40. 4-track monaural pushbutton unit records and plays back 3 speeds. Equipped for dual sound effects. Built-in permanent dynamic speaker. Input jacks for microphone, radio, phonograph, telephone adapters. Output jacks available for external loudspeaker, remote control, earphones, playback through radio, 8-mm



film projectors or connection to second tape recorder. Built-in splicing rule, tape counter, magic-band recording level indicator. Flywheel drive and tone and monitoring controls.—Majestic International Sales, Inc., 743 N. La Salle St., Chicago, Ill.

MONAURAL TAPE RECORDER, model SFC62N. Automatic 2-speed control, tone control operates on record and playback. Neon-recording level indicator; pause and edit control; separate jacks for mike, external speaker

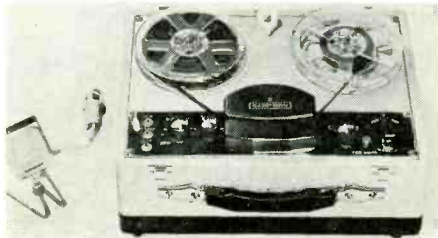

and radio-phono. Safety interlock. Precision braking; wow and flutter less than 0.35%. Patch cord, professional desk stand mike, two 5-in reels, 600 feet of tape. Accommodates up to 7-in reels.—The Sampson Co., Electronics Div., 2244 S. Western Ave., Chicago 8, Ill.

ALL-PURPOSE MICROPHONE, model D55. Response 70-15,000 cycles. Two sound entrances at back of diaphragm provide unidirectional polar characteristics for this dynamic mike. Correct positioning of unit controls program feedback,

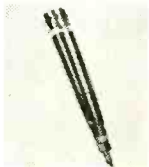

etc., in PA systems. Moving a wire alters impedance from 50 to 40,000 ohms. 11-oz. unit equipped with 18-foot, two-conductor shielded cable. Available in phased, matched pairs.—American Microphone Mfg. Co. (Div. G. C. Electronics, 400 S. Wyman St., Rockford, Ill.

TRANSISTORIZED POWER CONVERTER, Continental 50-191. Changes 12-volt battery current to 110-volt 60-cycle ac. Capacity 275 watts continuous, 300 watts intermittent. For operating tape recorders, TV sets, sound cameras, amplifiers, test equipment, hand-power tools and

Announcing
The Mullard
Master 10M Series

2 Year Guarantee

This Master 10M tube is guaranteed for ten thousand (10,000) hours of effective performance within the two year period from date of purchase. Should this tube fail, it will be replaced within the two year period. Mullard Tube Co., New York, N.Y.

**An Outstanding New Mullard Tube Line Ideal for
The Full Range of Electronic Equipment...
Guaranteed Performance... Tube-To-Tube Uniformity**

Now almost every popular receiving and entertainment type tube is available in a selected laboratory-tested Mullard series that is guaranteed for 10,000 hours of effective performance within two years from the date of purchase.

Each tube in the Mullard Master 10M Series meets tightened, more stringent requirements. Each has been selected and individually laboratory-tested to assure long life and highest quality performance plus extreme tube-to-tube uniformity and section-to-section uniformity. Gold-protected pins point up each tube's high quality... prevent confusion with ordinary types. Each 10M tube is individually cushioned in plastic foam for protection during handling and shipping.

To insure the performance for which your equipment was designed and satisfy the constant and growing need for technically-advanced and reliable tubes, use Mullard Master 10M Series tubes. Now available from your Mullard 10M distributor or write us direct for descriptive literature.



IEC INTERNATIONAL ELECTRONICS CORPORATION
81 Spring St., New York 12, N. Y.

*Developed in the field
to pay off in performance
down the road*



only **\$159⁹⁵**
(S-meter optional extra)

New
Littlephone[®]

CB-3A
dual conversion
citizens band

TRANSMITTER/RECEIVER

New, improved version of Hallicrafters' high-performance CB-3 27-mc. transmitter/receiver—incomparable result of a 30,000-mile, continuous-operation field test under the most punishing conditions imaginable.

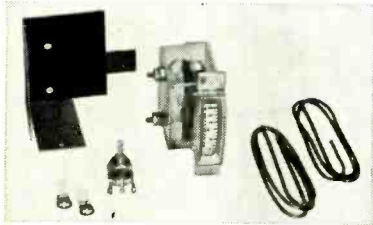

S-meter kit—easy to install as shown in photo above. \$8.95

Features:

- 8-channel, crystal controlled convenience
- Dual conversion
- Improved electronic squelch
- Provision for S-meter
- Built-in jack for remote speaker and future accessories
- Audio output over 2 watts
- 6 kc. selectivity
- FCC type-accepted.

the new ideas
in communications
are born at . . .



hallicrafters

5th and Kostner Aves., Chicago 24, Illinois

QUICK and LASTING

When You Use
HUSH[®]

Chemically-Electronically, engineered for Tuners and Switching Mechanisms.

When New HUSH is applied it will wash-away that dirt, leaving clean and positive contacts protected by a lasting lubricant. New HUSH is made from the finest solvents and it contains Electro-Silicone oils.

6 oz. Spray can. Also available 2 oz., 8 oz., 32 oz. containers
FREE 6" Plastic Extender With Every Can

EVER-QUIET[®]

Since 1949

VOLUME CONTROL AND CONTACT RESTORER

EVER-QUIET is a free-flowing liquid that leaves no powder residue. Scientifically designed to seep around the shaft and penetrate the control or potentiometer, cleaning the contacts and leaving a safe protecting film. Harmless to metals, wire or carbon.

2 oz. Bottle & dispenser. Also available—6 oz. Spray can



CHEMICAL ELECTRONIC ENGINEERING, INC., Matawan, New Jersey

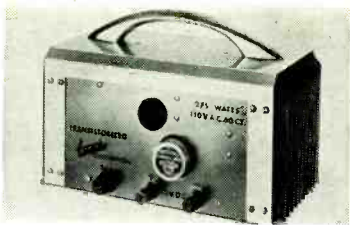

universal type ac-dc motors to ¼ hp. Remote control, cables, battery leads.—Terado Corp., 1060 ½ Raymond Ave., St. Paul 8, Minn.

INDEXED STORAGE CHEST, for film and recording tape. Holds 12 styrene containers, accommodates all 5- and 7-in recording tape plus

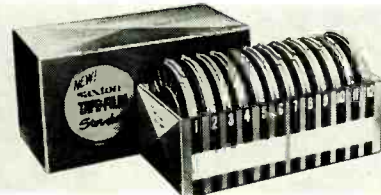

8-mm home movie film. Swivel-twist lock.—Saxton Products, Inc., 4320 Park Ave., Bronx 57, N. Y.

SWITCH KNOBS, contoured top and bottom, tapered sides, for Lev-R and Telever



switches. Red, black, milky white.—Switchcraft, Inc. 5555 N. Elston Ave., Chicago 30, Ill.

REPLACEMENT KNOB HEADS, 6 types to fit stems currently in stock. Also 21 new



stems, assorted lengths, to fit various shafts.—Colman Electronic Products, 1017 N. E. 3rd Ave., Amarillo, Tex.

OUTLET BOX, Safcord, model W-1. For quick installation of multiple electric outlets. 6 heavy-duty standard receptacles, on-off switch,

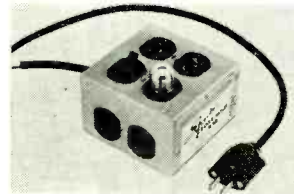

pilot light. 10 feet heavy-duty appliance cord. Both sides of line fused. 120-volt unit rated at 10 amps, 1,200 watts.—R. Moranski, Dept. RE-1, 61 Trudy Lane, Buffalo 25, N.Y.

CHEMICAL SPRAYS. 6-oz aerosol spray cans contain Super Freeze Mist for pinpointing bad components through quick cooling. Spray-Kleen lubricates and eliminates noise caused by



dust and corrosion on switches, relays, and sliding contact devices. Super Contact Cleaner, heavy-duty spray with silicone compound, protects all controls.—GC Electronics, Div. Textron, 400 S. Wyman St., Rockford, Ill.

SOLDERING KIT, model 8250AK. Includes 250-watt heavy-duty soldering gun with twin spotlights, smoothing tip, cutting tip,



wrench, supply of solder. Self-hinged polypropylene case.—Weller Electric Corp., 601 Stones Crossing Rd., Easton, Pa.

PORTABLE CABINET, Atlas. Plastic compartments hold electronic parts for the radio-TV



service technician.—Akro-Mils, Inc., 820 E. Market St., Akron 9, Ohio.

MIDGET-SIZE SCREWDRIVER, cat. no. BR18Y. Beryllium-copper, nonmagnetic, non-sparking. For electrical and electronic assembly



and service. $\frac{1}{8}$ x 2-inch beryllium-copper round blade in plastic handle fitted with pocket clip.

Overall length 4 $\frac{1}{4}$ inches.—Xeelite, Inc., Orchard Park, N. Y.

MUTUAL-CONDUCTANCE TUBE TESTER KIT, model TT-1A. Built-in adapter for testing compactron, nuvistor, Novar and 10-pin miniature types. Checks G_m and grid current in multi-element tubes; diodes, rectifiers, voltage regulators, low-power thyratrons, electron eye-



tubes. Indicates G_m to 24,000 micromhos. Individual selector switches; disconnect switch; built-in, switch-operated calibration circuit. All tube test data on built-in roll chart.—Heath Co., Benton Harbor, Mich.

TRANSISTORIZED SIG GEN, model 36-564. Signal injection device for af and rf/af. Variable output level 400-cycle audio signal generated.



18-inch leads, insulated alligator clip, thin test probe. 16-oz. 6-volt battery, 2 transistors, on/off switch on control potentiometer.—GC Electronics, Inc., Div. Textron Electronics, Inc., 400 S. Wyman St., Rockford, Ill.

PORTABLE GRID-DIP METER. Fully transistorized. 14-oz. 1-hand operation. Measures



resonant frequencies, checks antenna resonance; locates parasitic frequencies as rf detector, absorption wavemeter and sig gen. Epoxy-coated plug-in coils, banana plugs. 5 coils (3.1-180 mc), phone jack, battery. Kit or assembled.—PEL Electronics, PO Box 555, Ridgewood, N.J.

BETA TRANSISTOR TESTER, model 1800. Tests silicon or germanium transistors, diodes, Zener diodes, accuracy $\pm 3\%$. Measures ac, dc beta, leakage, other transistor characteristics.

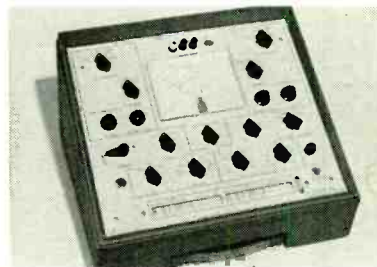

Built-in roll chart lists data for beta and leakage tests on more than 1,550 transistors. 7 leakage ranges cover 0-0.05 μ a full scale to 0-25 ma full scale. Chopper and high-gain amplifier for leakage current measurement on low-current scales. Instruction manual gives manufacturer's data for I_{EBO} , I_{CBO} , input resistance, output conductance, mutual conductance and collector saturation voltage. Continuously variable V_{CE} and I_C provide tests based on user's special requirements.—RD Instruments, Div. Hickok Electrical Instrument Co., 10514 Dupont Ave., Cleveland 8, Ohio.

If you can't afford a Fisher tuner... build one!

Introducing the newest Fisher StrataKit: the KM-60 FM-Stereo-Multiplex Wide-Band Tuner. Fisher FM tuners have always been reasonably priced considering their unsurpassed sensitivity and matchless overall design—but, even so, not everyone can afford them. If economics have thus far deterred you from buying the very finest, the new Fisher KM-60 StrataKit solves all your problems in exchange for a few evenings of entertaining and instructive work. It incorporates Fisher FM engineering at its most advanced, including built-in Multiplex and sophisticated wide-band circuitry—yet it costs almost one-third less than the nearest equivalent Fisher-built tuner.

This spectacular saving involves absolutely no risk, even if you are "all thumbs." The StrataKit method of kit construction has eliminated the difference between the expert technician and a totally unskilled person as far as the end result is concerned. You assemble your StrataKit by easy, error-proof stages (strata), each stage corresponding to a particular page in the Instruction Manual and to a separate transparent packet of parts. Major components come already mounted on the chassis, and wires are pre-cut for every stage—which means every page!

In the KM-60 StrataKit, the front-end and Multiplex circuits come pre-aligned. The other circuits are



aligned by you after assembly. That is accomplished by means of the tuner's laboratory-type d'Arsonval signal-strength meter, which can be switched into each circuit without soldering.

This is the world's most sensitive FM tuner kit, requiring only 0.6 microvolts for 20 db quieting! (IHFM-standard sensitivity is 1.8 microvolts.) Capture ratio is an unprecedented 2.5 db; signal-to-noise ratio 70 db. The famous Fisher "Golden Cascade" RF stage, plus four IF stages and two limiters, must take most of the credit for this spectacular performance and for the superb rejection of all spurious signals. Distortion in the audio circuits is virtually non-measurable.

An outstanding feature of the Multiplex section is the exclusive Stereo Beam, the Fisher invention

that shows at a glance whether or not an FM station is broadcasting in stereo. It is in operation at all times and is completely independent of the tuning meter. Stereo reception can be improved under unfavorable conditions by means of the special, switchable sub-carrier noise filter, which does not affect the audible frequency range.

Everything considered, the KM-60 is very close to the finest FM tuner that money can buy and by far the finest you can build. Price \$169.50.*

The Fisher KX-200 80-watt stereo control amplifier StrataKit, \$169.50.*

*Walnut or Mahogany cabinet, \$24.95. Metal cabinet \$15.95. Prices slightly higher in the Far West.

USE THIS COUPON FOR FURTHER INFORMATION

Fisher Radio Corporation
21-51 44th Drive,
Long Island City 1, N. Y.

Please send me without charge the complete Fisher StrataKit catalogue.

Name _____
Address _____
City _____ Zone _____ State _____

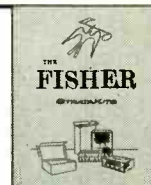

RE513

THE HARMON P-315A REGULATED POWER SUPPLY

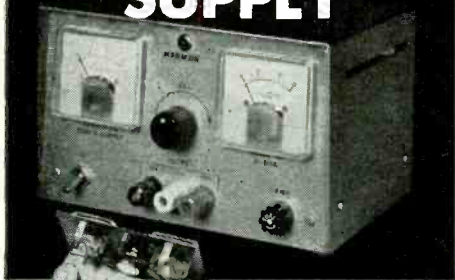

GIVES YOU
... all these features
at this low price *

... and it is lightweight and compact enough to make it ideal for field work, despite the fact that it is in the category of the finest laboratory equipment by performance standards.

Whether you are working with transistorized circuits, hybrid tubes, or are involved in any test, maintenance or design work requiring 0 to 15 volts of d.c. at up to 3 amps, you will be delighted with this new Harmon Power Supply. The full wave filtered output will supply "lab-type" power at continuous current loads and the .1% regulation at inputs varying from 105 to 125 volts A.C. (55 to 65 cycles) insures 100 microsecond recovery time during voltage surges. This compact package weighs but 5 1/4 pounds and measures 8 3/8" x 6 7/8" x 5 3/8".

SPECIFICATIONS

Input	115 volts a.c., 55-65 cps.
Voltage Regulation	±1% at 115 volts. Input voltage may vary from 105 to 125 volts.
Output	0-15 volts d.c., fully regulated, at up to 3 amperes.
Circuitry	Solid-state. 4 power transistors, heat-sink mounted.
Ripple	10 mv. RMS at 50% load current; 30 mv. RMS at full load.
Fusing	All components short-circuit protected.
Recovery Time	Less than 100 microseconds after full load surge.
Voltage Control	Precision Potentiometer

*INTRODUCTORY PRICE **99⁵⁰**

Available through your electronic distributor. Write for technical brochure and name of nearest distributor.

GEORGE HARMON
Company Inc.
18141 Napa St. • Di 5-1620 • Northridge, Calif.

IGNITION ANALYZER, model TE-10. Locates trouble in coils, spark plugs, points, capacitors. Direct-reading meter. Vtvm section measures to 30,000 volts without circuit drain.

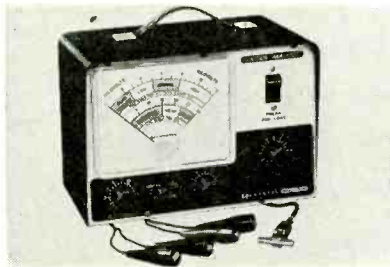

Capacitance clip for shock-proof high-voltage measurements, including surges. Power derived from 12-volt car battery; may be used on all 4-, 6- and 8-cylinder engines. Variable resistance-loading circuit simulates heavy engine load.—Lafayette Radio Electronics Corp., 111 Jericho Turnpike, Syosset, N. Y.

TRANSMITTER DUMMY LOAD, Can-tenna. Handles power to 1 kw, less than 1.5 vswr to 300 mc. Impedance 50 ohms. Coax

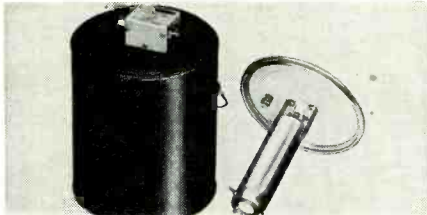

input connector for transmitter, phono jack for dc output to vom or vtvm. Oil-cooled temperature-stable resistive element. Oil capacity 1 gal.—Heath Co., Benton Harbor, Mich.

TRANSISTORIZED FISH ATTRACTOR, Son-lure, model 1000. Sonic-impulse device attracts predatory game fish from as far as 2



miles away to vicinity of user. Use in fresh or salt water.—H. McCune Co., 16255 Ventura Blvd., Encino, Calif.

All specifications are from manufacturer's data

NEW BUSINESS GETTERS

NEW LITERATURE

REPLACEMENT NEEDLE WALL CHART listing replacement needles by cartridge number, illustration of needle replacement, record speed, and needle number in either diamond, jewel or osmium.—Duotone Co., Keyport, N.J.

WINDOW POSTER for service technicians. The 17 x 22-inch poster urges people to stop

- 1
- 2
- 3
- 4
- 5

tinkering and trust TV repairs to the professional. When writing ask for Form Rp-26.—Sprague Products Co., 81 Marshall St., North Adams, Mass.

CARTRIDGE/NEEDLE SALES AIDS include wall charts, cartridge dispensers, storage

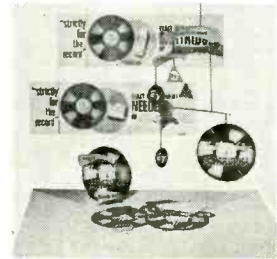

bins, counter displays, mobiles, banners and plastic tray merchandisers.—Electro-Voice, Inc., Buchanan, Mich.

SERVICE SELECTOR. 40-page catalog describes capacitors, vibrators, rotors, decodes, test instruments, other components. Includes illustrations, design features, temperature ranges, material construction, application and price.—Cornell-Dubilier Electronics Div., Advertising Dept., Federal Pacific Electric Co., 50 Paris St., Newark, N. J.

TEST ACCESSORIES—patch cords, cable assemblies, socket savers, test-socket adapters, mold test plugs—shown in 12-page *Catalog 7-62* is illustrated with many photos, offers complete technical data.—Pomona Electronics Co., Inc., 1500 E. 9th St., Pomona, Calif.

POWER PENTODE 6GB5 presented in 10-page illustrated booklet. Includes photos, diagrams, graphs of cavitrap plate, plus operation data on 6GB5. Request on company letterhead.—Amperex Electronic Corp., Semiconductor & Special Purpose Tube Div., 230 Duffy Ave., Hicksville, N. Y.

AMATEUR BAND RECEIVER NC-155 described in data sheet, with technical information and photos.—National Radio Co., Dept. RP, Melrose 76, Mass.

TRANSISTORIZED VOLTAGE REGULATORS, ICE-254, Application Guide. Describes design procedures and solution to sample design problems for series, shunt and combination series-shunt regulators.—Semiconductor & Materials Division, RCA, Somerville, N.J. 25¢

CLIPS AND INSULATORS detailed in *Catalog No. 250*. Gives sizes, materials, characteristics and capacities of 66 products.—Mueller Electric Co., 1567Y E. 31 St., Cleveland 14, Ohio.

BARRY'S GREEN SHEET, 31-page Feb.-Mar. 1962 Catalog. Features electronic tubes, semiconductors, transformers, chokes, meters, wire, test equipment, etc., for the industrial market.—Barry Electronics Corp., 512 Broadway, New York 12, N. Y.

METAL FASTENERS outlined in *Catalog PL-NL*. Lists complete line of staples, Lock Nails and wire for use with any type of manufacturer's industrial tackers, staplers, etc. Detailed selection data and specifications are included in the catalog.—Heller Roberts Instruments Corp., 6115 Carnegie Ave., Cleveland 3, Ohio.

LEVER TYPE SWITCHES described in 4-page *Catalog No. S-307*. Engineering drawings, specs and operating features, plus colored illustrations.—Switchcraft, Inc., 5555 N. Elston Ave., Chicago 30, Ill.

CLIPS AND INSULATORS offered in 8-page *Catalog No. 250*, with description and illustration of approximately 70 items. Also included are display material and other sales aids. Mueller Electric Co., 1583 E. 31st St., Cleveland 14, Ohio.

Any or all of these catalogs, bulletins, or periodicals are available to you on request direct to the manufacturers, whose addresses are listed at the end of each item. Use your letterhead—do not use postcards. To facilitate identification, mention the issue and page of RADIO-ELECTRONICS on which the item appears. UNLESS OTHERWISE STATED, ALL ITEMS ARE GRATIS. ALL LITERATURE OFFERS ARE VOID AFTER SIX MONTHS.

To help you get ahead and stay ahead in the competitive servicing field

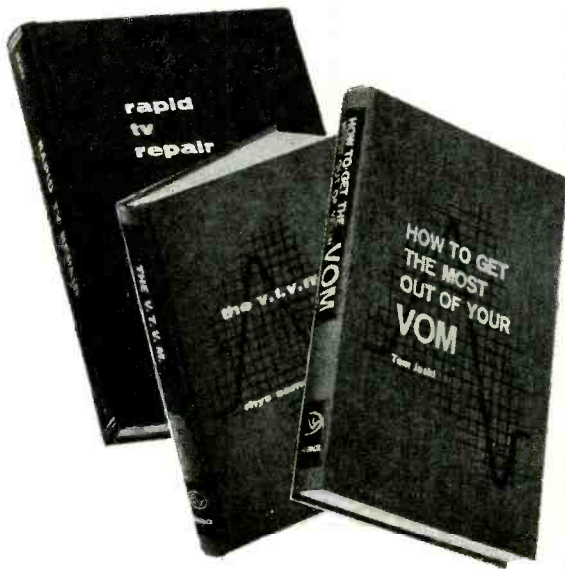

WE INVITE YOU TO

Accept These 3

IMPORTANT SERVICING BOOKS
(value \$13.80) **\$2⁰⁰**
FOR ONLY

with membership in the
G/L Technician's Book Club

The Gernsback Library Service Technician's Book Club was designed to help you get ahead faster by providing a steady, expert source of vital, up-to-the-minute electronics servicing know-how—at a price you can afford!

To introduce you to this club, we invite you to accept the 3 fact-packed books on this page—value \$13.80—for only \$2.00 But please act quickly. Quantities are limited. First come first served!

Nowhere else can you find so many tips, short-cuts, and time-saving techniques at such low cost or find theory and fundamentals explained so clearly by top-notch technical writers—put it to work immediately! Gain a reputation as the most reliable service technician in your area—and make the money that goes with the reputation!

MONEY-MAKING SERVICING KNOW-HOW AT YOUR FINGERTIPS WHENEVER, WHEREVER YOU NEED IT MOST!

These are just a sample of the scores of top-notch electronics books—from leading publishers—that can be yours at savings (up to 27%!) as a member of the G/L Technician's Book Club.

Every month, you will receive a brochure describing a large assortment of the best electronic books. You needn't purchase a book each month—nor any particular book any month. Your only obligation as a member is to buy as few as 4 additional books within the next 12 months. You may cancel anytime thereafter.

Now—start moving ahead faster. Accept these 3 books for only \$2.00 plus a few cents postage with membership. If you don't agree that they're worth their weight in tax deductions*, return them within 10 days and owe nothing. Mail coupon today to Gernsback Library, Inc., Dept. 32B, 154 West 14th St., New York 11, N. Y. Send no money now, unless you wish.

*Books purchased for professional purposes are tax deductible.

EVERY MONTH—YOUR CHOICE OF MONEY-MAKING BOOKS LIKE THESE IN EVERY FIELD OF SERVICE & SERVICING EQUIPMENT

- Advanced Servicing Technique
- Color TV
- Basic Transistor Course
- Business Practices for Electronic Technicians
- Hints & Kinks
- Picture Book of TV Repair
- Basic Math for Technicians

HOW TO GET THE MOST OUT OF YOUR VOM—Reg. Price \$4.60

By Tom Jaski • This book shows you how to make your VOM stand up and do tricks! Tells how and why it works, how to choose the best one for your needs, how to use, care for it, put it to new uses, extend its range, increase its accuracy. It analyzes commercial types and kits and tells you how to build your own.

RAPID TV REPAIR — Reg. Price \$4.60

By G. Warren Heath • One of the most valuable servicing books ever written! Lists hundreds of tough TV problems, alphabetically for easy reference. Tells you how to find 'em and fix 'em in minutes. No theory—just practical hints, plus many time-saving troubleshooting charts.

THE VTVM — Reg. Price \$4.60

By Rhys Samuel • How to get the most out of this electronic workhorse! Suggests many new time-saving uses. Tells how and why the VTVM works, describes meter scales, probes and cables and explains the use of the VTVM in TV troubleshooting, AM-FM alignment and repair, servicing audio amplifiers, etc.

TECHNICIAN'S BOOK CLUB
Gernsback Library Dept. 52B
154 West 14th Street, New York 11, N. Y.

Enroll me as a member of the G/L Technician's Book Club. Start my membership with How To Get The Most Out Of Your VOM • Rapid TV Repair • The VTVM for only \$2.24 (including postage). Each month send me a brochure describing the current selections which I may purchase at special discount prices if I wish. I understand that my only obligation is to purchase just 4 additional books within the next 12 months, and that I may cancel anytime thereafter. I also understand that I may cancel immediately, simply by returning these first 3 books within 10 days.

THIS OFFER GOOD IN U.S.A. & CANADA ONLY

NAME _____
ADDRESS _____
CITY _____ ZONE _____ STATE _____

BIG LINE OF SMALL SPEAKERS

UTAH'S SEVEN
BASIC "MINIATURES"
FIT BOTH IMPORTED
AND DOMESTIC
TRANSISTOR RADIOS



Here's the solution for replacing speakers in transistor radios. With this complete line of midget speakers (American made with American parts) Utah provides a dependable source for replacements. Wafer-thin baskets, 12 ohm V.C. impedance—for performance equal or better than original speakers.

Model No.	Size	Total Diam.	Basket Depth	Total Depth
SP2T	2" Round	2"	7/32"	11/16"
SP22T	2 1/4" Round	2 1/4"	1/4"	3/4"
SP25A	2 1/2" Square	2 1/2" Square	1/2"	1 3/16"
SP25T	2 1/2" Round	2 1/2"	3/8"	27/32"
SP27T	2 3/4" Round	2 3/4"	1 1/2"	1 3/4"
SP27A	2 3/4" Round	2 3/4"	1 1/2"	1 3/4"
SP3T	3" Round	3"	1 1/2"	1 3/4"

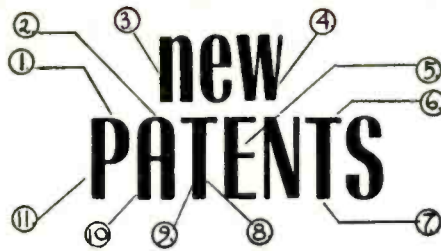

SPEAKER ENCLOSURE

Patent No. 2,969,848

Claude C. Farrell, 6 School St., Groton, Mass.

Close coupling between speakers is known to increase fidelity and efficiency. Here is an enclosure designed to couple two 12-inch speakers fed in the same phase.

The space between speakers opens into a "throat" and into a "horn space" which transmits the sound into the room. The chambers are lined with sound-absorbing material, and their joints are reinforced with blocks. The cabinet is made of 3/4-inch plywood.

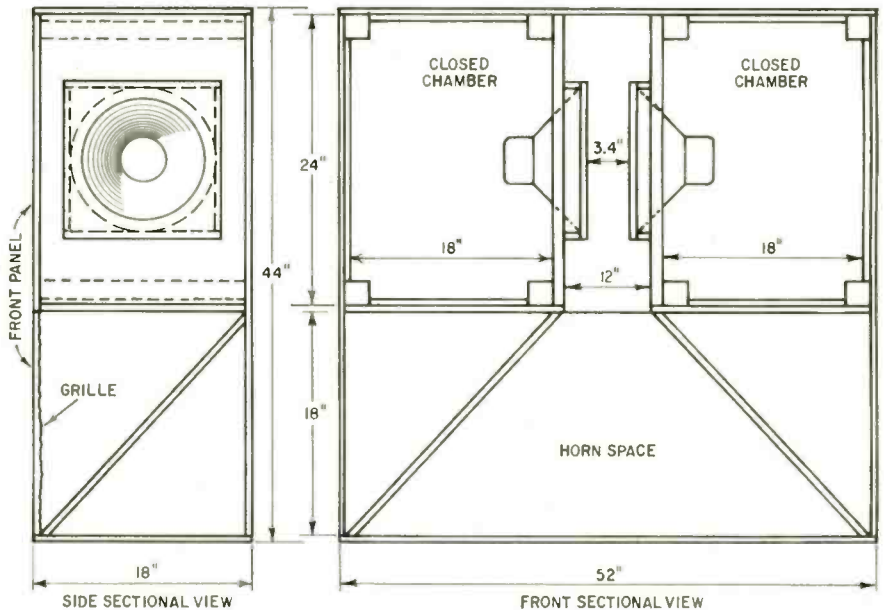
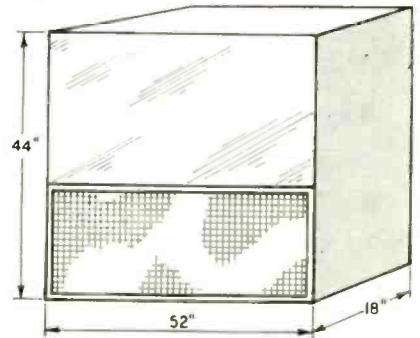

NO-WIND CLOCK

Patent No. 2,957,116

Edwin W. Hurd, Leo Goran, Jr., and Charles E. Fischer, Detroit, Mich. (Assigned to Hurd Lock & Mfg. Co., Detroit)

This clock is regulated by a spring and balance wheel. A transistor circuit feeds a pulse of energy to the wheel at regular intervals to compensate for friction loss.

The transistor circuit (Fig. 1) is energized

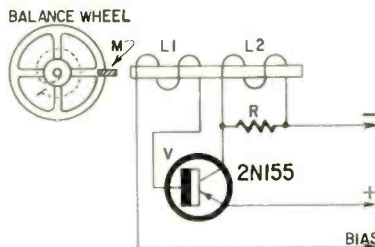

Fig. 1

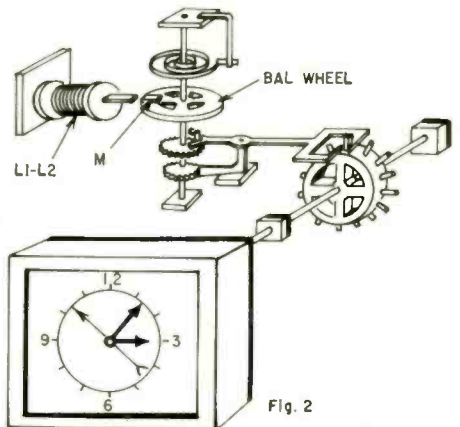

Fig. 2

regenerated until full collector current flows through L2. It energizes the core with polarity that repels M. The collector pulse quickly decays.

After the wheel has completed its swing, the spring reverses its motion and again the core attracts M. An instant after M passes the core, it is again repelled by it. Thus the balance wheel oscillates as long as dc is applied to the transistor.

Fig. 2 shows mechanical details of the clock as suggested by the inventor. Also, he describes an unbalanced bridge using temperature-sensitive resistors (not shown) for maintaining a constant dc input to the transistor.

by dc. Its base is reverse-biased by about 0.3 volt to keep it nonoscillatory. Resistor R damps out any oscillations that may tend to arise.

Magnet M is mounted at the rim of a balance wheel. L1, L2 are wound over a magnetic core and poled for regenerative action. With the core not energized, M is attracted to it. As M passes the core, it generates a negative pulse which is fed to the base of V. The pulse is

ENP

TECHNICIANS'

NEWS

TRI-STATE ELECTION

Camden, N. J.—Members of the Tri-State Council of TV Service Associations elected the following officers: Tony deFranco, president; Wm. Jordan, vice president; Arnold Zenker, secretary, and Joseph Eberhardt, re-elected treasurer. Carl Welk was appointed publicity director. The Tri-State Council is made up of members of the Allied Electronic Technicians Association of New Jersey, Television Service Dealers Association of Delaware; Television Service Dealers Association of Delaware County, Inc., (Pennsylvania) and the Radio Servicemen's Association of Trenton, N. J.

ACTSA ELECTS

Ashtabula, Ohio—Election and installation of officers was the business at hand at a recent meeting of the Ashtabula County Television Servicemen's Association. The new officers are: Edward Cimorell, president; Nick Notter, vice president; Jack Stranahan, secretary; Frank Abbott, Treasurer; Joe Horvath, director of NATESA and TESA; Ed Laatu, Carl DeMarco, and Joe Turk, junior vice presidents, and John Campagne, historian and sergeant at arms.

The group's goal for 1962 is to make the ACTSA technician the best technician available.

NEW TECHNICIANS GROUP

Columbia City, Ind.—Technicians from Churubusco, South Whitley and here met at City Hall to organize a new service association. One of the first steps taken by the group was to elect officers. They are: David F. Martin, president; Joe Weaver, vice president; I. C. Ohlwine, secretary, and Marshall Sevits, treasurer.

MULTIPLEX MEETING

Detroit, Mich.—Radio Distributing was packed with 65 TSA members and their technicians for a service meeting on FM multiplex stereo. A smorgasbord dinner was served at 7 pm and the service meeting got underway at 8 and lasted till 10:30.

Zenith field engineer Ed Kob was speaker and proved to be a capable talker and instructor. As a part of his presentation he pointed out that the circuit and tubes had been used before, but in other applications. He also stressed that, while ghosts on TV might be lived with, they were intolerable in FM stereo because they show up as distortion. It was a very profitable evening for those attending.

Precision performance
is your passport to
the amazing world of
short-wave listening



hallicrafters

5th and Kostner Avenues, Chicago 24, Illinois
"world-range" radio



S-119K Sky Buddy Receiver Kit—\$39.95.
S-119 (factory wired and tested) \$49.95.
Standard broadcast. Two short wave bands (2-5.5 Mc. and 5.7-16.4 Mc.). Superheterodyne circuit. Transformer-type power supply.



SX-62A Receiver—\$395.00. Standard and FM broadcast. Three short wave bands. (1.62 Mc-109 Mc). Excellent audio. Slide rule dial. Single tuning control. Automatic noise limiter. Uses R-48 speaker. (\$19.95)

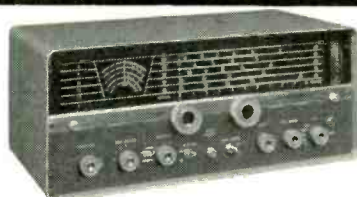

SX-110 Receiver—\$169.95. Standard broadcast. Three short wave bands (1550 kc-34 Mc). Slide rule electrical bandspread dial. Built-in "S" meter, antenna trimmer, crystal filter. Uses R-48 speaker (\$19.95).

S-120 Receiver—\$69.95. Standard broadcast plus three short wave bands (1650 kc-31 Mc). Three-way antenna system. Slide rule electrical bandspread dial. B.F.O./selectivity control.

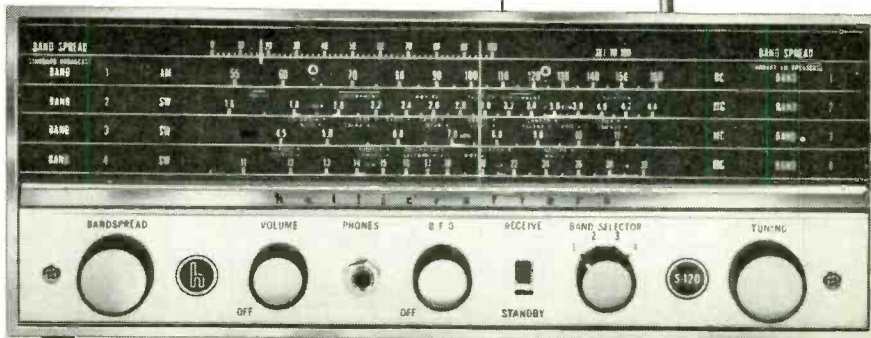

Export Sales: International Division, Raytheon Mfg. Co., Waltham, Mass. Canada: Gould Sales Co., Montreal, P. Q.

TRAIN WITH THE LEADER



FOR YOUR FCC LICENSE

Prepare for your First Class FCC License through NRI's special and up-to-date FCC home-study course. Qualify for better paying jobs and growing opportunities open to you with your FCC "Ticket." Train with NRI—oldest and largest school of its kind. **MAIL NOW** →

National Radio Institute
Washington 16, D. C.

Send me information on NRI's special FCC License training. (No representative will call. PLEASE PRINT)

Name.....Age.....
Address.....
City.....Zone.....State.....
Accredited Member National Home Study Council

the
business-like
approach

to
SERVICE
CHARGES
and
RECORD
KEEPING



For customer's prices on every replacement part, plus flat rate and hourly service charge data, regional and national. Dave Rice's OFFICIAL PRICING DIGEST, listing over 63,000 items. \$2.50.

▲ AVAILABLE FROM YOUR DISTRIBUTOR ▼

If you want to operate on a professional level, Dave Rice's OFFICIAL ORDER BOOKS give you triplicate forms for order, invoice, and office records...spaces for tubes, parts, serial numbers, labor and tax charges, signatures, etc. 75c per book, \$6.50 for dust-proof box of 10.

Dave Rice's



ELECTRONIC PUBLISHING COMPANY, INC.

133 N. Jefferson St. • Chicago 6, Ill.

Ask By Name For
GENUINE
"NO NOISE"
PRODUCTS

your assurance
of brand name
quality

NO-NOISE
Volume Control
and CONTACT RESTORER
• Cleans
• Protects
2 oz. Bottle
\$1.00
Net to Servicemen

• Lubricates
• Restores
6 oz. Spray Can
\$2.25
Net to Servicemen



Not a Carbon Tet Solution

NO-NOISE
TUNER-TONIC
with PERMA-FILM
• Cleans, lubricates, restores all
• Tuners, including wafer type.
• Non-toxic, non-inflammatory.
• For TV, radio and FM use.
• Economical—a little does a lot.
6 oz. Aerosol Can
\$3.25
Net to Servicemen



FREE
with each can of
ELECTRONIC
CHEMICAL
products—
15" PLASTIC
EXTENDER
• Push Button
Assembly
• For Pin Point
Applications
• Does Not
Cause Shorts



Electronic
Chemical new
formula EC-44
Lubricates, cleans
all electrical
contacts. Econo-
mical... a
little does a lot!

6 oz. spray can
\$3.50
Net To Servicemen.

ELECTRONIC CHEMICAL CORP.

813 Communipaw Avenue Jersey City 4, N. J.

CSEA BANQUET

Los Angeles, Calif.—The 1962 Annual Banquet of the California State Electronics Association was the setting for a talk on "The Importance of the Independent Service Technician—Today and Tomorrow." The speaker was R. H. Bowden, president of Sencore Inc. His talk revealed his conviction that the future can be bright if the technician will keep abreast of the newest developments in testing methods and concentrate on sound business principles and improved public and customer relations.

INDIANA CIRCUIT

Kokomo—First business was to distribute copies of the association's constitution and bylaws. Next came elections. Ernest H. Golieb is the new president; Joe Martin, vice president; Robert F. Cripe, secretary, and Harold Crume, treasurer.

Ernie Golieb and Joe Martin tied on two successive ballots for president. It was moved and carried that the winner be decided by the toss of a coin, with the runner-up being vice president. Golieb won by a head.

Evansville—RTSA held its 17th Annual Combination Ladies Night and Installation Banquet. Official installation ceremonies were preceded by a family-style banquet dinner. Games and other entertainment followed.

J. Paul Wurtz turned over the president's chair to Charles F. Wilhelm. Gerald Joe Julian is the new vice president; Jerold K. Sweeny, secretary, and Don Wurtz, treasurer.

Logansport—And more election returns—president, Bill Boller; vice president, Frank Pickens; secretary, John E. Hill, and treasurer, Glenn Ogle.

Elkhart—Here too election news is the important item for the month: President, Wayne L. Clem; vice president, Arden Gaerte; secretary, Dean R. Moch, and treasurer, Hubert McAllister.

NO TV SERVICE ON SUNDAY

Kansas City, Mo.—It's against the law to do any TV servicing on Sundays, and TESA is backing it—unanimously. Under the state's Sunday Sales Law (TV service is included), TV service shops are required to close, along with most other retail businesses.

PRICE LIST

Wisconsin—The following price list appeared in the February 1962 issue of TESA-Wisconsin News. The prices shown apply to that particular service area and may differ from state to state and even from city to city.

These suggested fees cover diagnosis of trouble, location, installation or repair of component or circuit including mechanical defects. Parts are additional. They are based upon a survey of operational expense of leading service companies, time studies and cost analysis of time required to accomplish the listed service operation on a wide variety of television receivers with operations performed by competent technicians.

Basic Service Fee—Tube Check—Cleaning chassis—Remove and replace—Setup..... \$ 4.00
1. Ac input circuit..... 7.25

ASK ABOUT Group SUBSCRIPTION RATES to RADIO-ELECTRONICS

ELECTRONICS

Engineering-Technicians

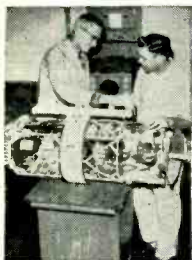

Heald's Micro-
wave and
Radar Labora-
tory Equip-
ment.

Bachelor of Science Degree, 30 Months

Save Two Years' Time

- Radio-Television Plus Color Technician (12 Months)
- Electronics Engineering Technology (15 Months)
- Electronics Engineering (B.S. Degree)
- Electrical Engineering (B.S. Degree)
- Mechanical Engineering (B.S. Degree)
- Civil Engineering (B.S. Degree)
- Architecture (B.S. Degree)

Approved for Veterans
DAY AND EVENING CLASSES

Write for Catalog and Registration Application.
New Term Starting Soon.

Your Name

Address

City

State

HEALD'S
ENGINEERING COLLEGE

Established 1863

Van Ness at Post, RE
San Francisco, Calif.

2. Audio circuit.....	15.45
3. Afc system.....	18.90
4. Agc system.....	19.10
5. Control: Single unit.....	6.75
Dual unit.....	9.75
6. Damper circuit.....	11.60
7. Deflection yoke and circuit.....	9.35
8. Filament circuit.....	11.65
9. Focus circuit.....	9.80
10. Horizontal oscillator circuit.....	17.85
11. Horizontal output circuit.....	14.55

90-DAY PARTS GUARANTEE

12. I. F. amplifier circuit.....	13.75
13. Picture tube: replacement.....	9.50
14. Power supply circuit (hi voltage):.....	14.20
15. Power supply circuit (low voltage):.....	12.45
16. Power transformer.....	10.45
17. Speaker.....	4.75
18. Selenium rectifiers.....	12.25
19. Sync circuit (vert or horiz):.....	17.60
20. Tuner (turret type):.....	12.50
21. Tuner (wafer type):.....	19.50
22. Tuner cleaning and lubrication (turret type):.....	4.25
23. Tuner cleaning and lubrication (wafer type).....	6.25
24. Tuner replacement or removal:.....	12.50
25. Vertical oscillator circuit.....	14.20
26. Vertical output circuit.....	12.20
27. Video circuit.....	12.55
28. Retrace blanking circuit.....	8.10
29. Printed circuits (concealed type).....	
Add \$8.50 to above price.....	3.85
30. Clean picture tube (removal).....	3.85

Alignment of Tuned Circuits

31. Video (complete).....	12.50
32. Sound (complete).....	8.75
33. Afc Circuit.....	7.75
34. Sound discriminator circuits.....	4.25
35. Tuner: local oscillators only.....	2.00
36. Uhf tuners.....	Hourly Rate
"Local-zone" average service fee.....	7.00
Additional TV shop fee—per hour or portion thereof.....	8.40
Analysis and location of trouble when estimate is given and set is not repaired.....	10.00
IWP (In warranty parts exchange fee).....	
50c per part—Minimum fee.....	1.20
Storage after 30 days: per month or portion thereof.....	2.00

AUTOMATIC TRANSLATIONS FOR THE SERVICE INDUSTRY

"It's probably just a condenser."
—Freely translated means—I've just spent \$14.00 on tubes and now the thing won't work at all.

"How much do you charge to replace a fuse?"—I was looking for a loose connection when something started smoking.

"I just had the set overhauled."
A friend put in some tubes last month.

"He didn't get it adjusted just right."—The antenna blew down last night.

"Can you just drop it off? I only live around the corner."—We live in a fourth-floor walkup.—*TSA Service News* **END**

CORRECTIONS

On page 51 of the March issue, the Amperex tube using Cavitrapp construction was erroneously designated as the 6BG5 in the caption. The tube, as the photo indicates, is a 6GB5. We thank Mr. George C. Loud, of Eastport, Me., for calling this to our attention.

There is an error in the heater circuit of the multiplex adapter on page 31 of the December 1961 issue. The heater pins of the 12AU7's are numbered 3, 4 and 9. The correct pin connections for the heaters are 4, 5 and 9.

We thank Mr. Robert Volino of Brooklyn, N. Y., for this correction.



The most Famous Name in
TOWERS of ALL KINDS!

Here are the advantages you get when you insist on ROHN TOWERS

LARGEST FULL RANGE OF TOWERS—you can get anything from home TV and amateur radio towers to heavy-duty communication and micro-wave towers. Included are 170 foot self-supporting towers, 1,000 foot guyed towers, and "fold-over" towers. Regardless of your needs, ROHN can supply it.

UNQUESTIONED LEADERSHIP IN DESIGN AND MANUFACTURE—you get the latest in advanced tower engineering. All communication towers are engineered to EIA specifications, and are proved by thousands of installations. No other manufacturer can surpass the quality and fine reputation of ROHN.

QUALITY MATERIALS AND WORKMANSHIP—Only highest quality steel is used which fully meets the specifications for the job. ROHN towers are hot-dipped galvanized **after fabrication**—a feature ROHN pioneered!

SERVICE WHEREVER YOU WANT IT—ROHN representatives are world-wide. Complete erection service for communication systems, broadcasting, micro-wave, and other needs is available; also competent engineering service to help you.

Settle for the BEST in TOWERS—ROHN—today the world's largest, exclusive manufacturer of towers of all kinds!

For your needs, contact your local ROHN salesman, distributor or dealer; or write direct for information.

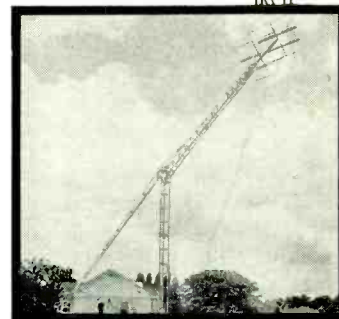

SEND THE HANDY COUPON INDICATING YOUR NEEDS

ROHN
Manufacturing Company
BOX 2000
PEORIA, ILLINOIS

ROHN Manufacturing Company
Box 2000
Peoria, Illinois

Send me complete literature on the following ROHN Products:

<input type="checkbox"/> Home TV Towers	<input type="checkbox"/> Amateur Towers
<input type="checkbox"/> Communication Towers	<input type="checkbox"/> AM-FM Broadcasting Towers
<input type="checkbox"/> Micro-Wave Towers	<input type="checkbox"/> Government

Name _____
Firm _____
Address _____
City _____ State _____

TV CAMERAS - COMPONENTS
6198 Vidicons \$34.50

Denson Electronics Corp.
Box 85 Rockville, Conn.

OUT OF SPACE?

You bet we'd be... if we were to tell you all about AUDION's "Out of this World Hi Fi Values."

Write for free Catalog

audion
25-E Oxford Road
Massapequa, New York

Please mention **RADIO-ELECTRONICS** when answering advertisements

CONVERT TO COLOR TV

COLORDAPTOR—A simple 10-tube circuit and rotating color wheel converts any size B & W TV to receive compatible color.

COLORDAPTOR — Easily attached to any TV set, does not affect normal operation, often built from parts experimenters have on hand. **BRILLIANT COLOR!**

Complete booklet—gives theory of operation, all construction details, schematic, and sample color filters..... **\$195**

Essential Parts Kit—includes all special parts—coils, delay line, crystal, color filters. Add \$1.00 for sets over 16". **\$19.95**

COLORDAPTOR 1798 Santa Cruz, Menlo Park, Calif.



in Radio-TV/ Sound Systems/Communications/Industrial Electronics

... wherever you serve most,
Stancor transformers serve you

BEST

Stancor makes the Transformer you need,
and your Stancor distributor has it in stock.
Precision engineering and rigid quality control assures your satisfaction—every time!

STANCOR

ELECTRONICS, INC.

formerly Chicago Standard Transformer Corporation
3501 WEST ADDISON • CHICAGO 18, ILLINOIS

Ask your distributor for a copy of the latest Stancor catalog—listing your widest choice of transformers for any branch of electronics.

LOOKING? — you stand a better chance of finding what you want if you advertise in **RADIO-ELECTRONICS** classified ads.

See details on Pages 104 and 105

FREE Catalog
OF THE WORLD'S FINEST
ELECTRONIC GOV'T
SURPLUS BARGAINS

HUNDREDS OF TOP QUALITY ITEMS—Receivers, Transmitters, Microphones, Inverters, Power Supplies, Meters, Phones, Antennas, Indicators, Filters, Transformers, Amplifiers, Headsets, Converters, Control Boxes, Dynamotors, Test Equipment, Motors, Blowers, Cable, Keys, Chokes, Handsets, Switches, etc., etc. Send for Free Catalog—Dept. RE.

FAIR RADIO SALES
2133 ELIDA RD. • Box 1105 • LIMA, OHIO

Fix Electric Appliances That DON'T WORK PAYS \$3 TO \$5 PER HOUR

FREE BOOK tells about profitable spare-time or full-time business. 400 MILLION Appliances now in use. People need them fixed. YOU make good money doing it—right at home! Easy course trains you for top earnings. At no extra charge you get Appliance Tester. Get **FREE Book**. **FREE Sample Lesson!** Mail coupon now.

NATIONAL RADIO INSTITUTE, Appliance Division
Dept. FE2, Washington 16, D.C.

Send **Free Book**, **Free Appliance Repair Course Lesson**.

Name.....
Address.....
City.....Zone.....State.....

NEW TUBES and SEMI-CONDUCTORS

NEW ITEMS ARE NOT AS NUMEROUS THIS month, but interesting just the same. There are a couple of sharp-cutoff pentodes for FM limiter and i.f. amplifiers; a solid-state negative resistance element; a Novar type TV damper; a sub-miniature voltage regulator; a group of "universal" picture tube replacements, and a triode nuvistor.

6HS6, 19HS6

Two 7-pin miniature sharp-cutoff pentodes for use in i.f. amplifier and limiter stages of FM receivers. They have extremely high transconductance (9,500 μmhos) and extremely low capacitance between grid 1 and the plate (.006 μf). Both also feature a "dark heater" which functions efficiently at operating temperatures 350°K below those of conventional heaters. Except for their heater ratings the two tubes are identical.

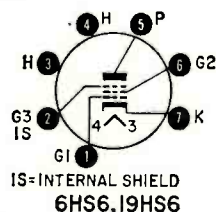

Characteristics of these RCA tubes when used as class-A1 amplifiers:

V_{HTR} (6HS6)	6.3
(19HS6)	18.9
I_{HTR} (6HS6) (ma)	450
(19HS6) (ma)	150
V_p (supply)	300
V_{G2} (supply)	300
V_{G1} (pos bias value)	0
(neg bias value)	50
P_p (watts)	3
P_{G2} (input) (watts)	
(for V_{G2} to 150)	1

Solid-state negistor

This semiconductor device is capable of operating as a negative-resistance element. It can be used as a switch, bilateral amplifier, or loss corrector in wave filters. It can also be used in mul-



tivibrators, switching circuits and linear amplifiers to reduce cost and complexity and improve overall operation.

A 2-terminal device, the Circuit-Dyne built Negistor is available in resistance values from 10,000 to 100,000 ohms in 5% increments. Resistance tolerances—2%, 5% or 10%—may be specified. The units are epoxy encapsulated and have either coaxial or single-ended leads.

6DW4

This Novar tube is a half-wave vacuum rectifier designed for damper service in horizontal-deflection circuits of color and block-and-white TV sets.

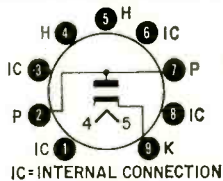

IC=INTERNAL CONNECTION
6DW4

Maximum ratings of the RCA 6DW4 in TV damper service are:

P_{PIV}	4,500
I_p (peak ma)	1,300
I_p (dc ma)	210
P_p (watts)	6.5
V_{H-K} (htr neg with respect to cath)	4,500
(htr pos with respect to cath)	300

8228/ZZ 1000

Subminiature voltage reference tube designed to be the most stable device now available. It has a temperature coefficient of 3 mv/C° (.004%/C°) over a temperature range of -55 to 70° C. Its nominal reference voltage is 82 at an average current of 2 ma. The

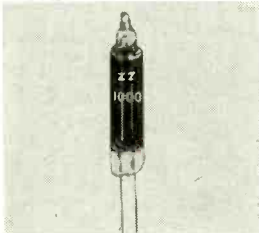

tube's variation in regulating voltage is less than 100 mv, due to its semi-hollow cathode and it is guaranteed for 30,000 hours of use. The Amperex 8228/ZZ 1000 is 1.2 inches long and 1/4 inch in diameter. It has leads which can be soldered into the circuit.

"Universal" Picture Tubes

RCA has announced 4 "universal" type picture tubes that will replace 33 existing types. The 4 tubes are said to take care of one out of two picture tube replacements handled by the service technician today.

The 21CMP4-A replaces:

21ALP4	21ALP4-A	21ALP4-B
21ANP4	21ANP4-A	21ATP4
21ATP4-A	21ATP4-B	21BAP4
21BNP4	21BTP4	21CBP4
21CBP4-A	21CBP4-B	21CMP4
21CVP4	21CWP4	21DNP4
21FLP4		

The 21AMP4-A replaces:

21ACP4	21ACP4-A	21AMP4
21AMP4-A	21AQP4	21AQP4-A
21BSP4	21CUP4	

MAY, 1962

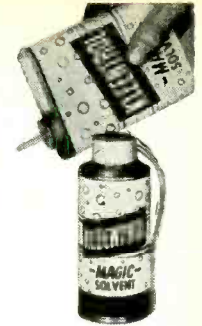
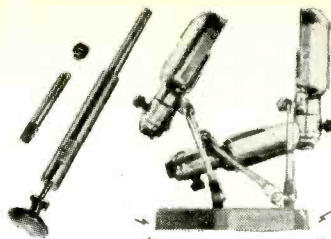

SHORT CUTS FOR SERVICE PROFITS!

FONO-MAGIC—a liquid compound of Special Rubber and precious carbide particles forms a live rubber coating on metal phono drive parts . . . stops slipping and dragging caused by crystallized rubber drive wheels. Contents are equivalent to the replacement of 100 idler wheels; will not wear off. dealer net. . \$1.95

TROLMASTER—cleans and lubricates TV-Radio controls in 60 seconds from the front of set without removing chassis or back from cabinet. Solid brass construction. dealer net. . \$3.95

MAGNA-LITE—superpowerful magnet clamps light to chassis, transformers, brackets, etc. Does away with flashlight servicing. 3-way swivel action puts light exactly where needed. net. . \$5.95

HUMI-KUP 2 SET COUPLERS—hermetically sealed for outdoor installation; all inductive circuitry; skin packaged for self service sales. List \$3.95. dealer net. . \$1.95

KLEENTROL MAGIC SOLVENT—approved by C.A.A.; contains no Carbon-Tet: non-flammable; will not harm finishes of wood, metal, or acetate parts. net (5-oz. spray can incl. injector tube) \$1.25 pint size. . \$1.95 net.

CARDIO MASTER—super powerful magnetic device designed to hold a portable transistor radio in the area of a car's windshield and make it operate as a car radio. List Price \$4.95 dealer net \$2.97

METAL STROBE—handy all metal speed determining tool that lasts a lifetime; 4 speed design. dealer net. . .99

NU-SHAFT—repairs broken clock-radio shafts without removing set from cabinet. Kit includes 7 Nu-Shafts and 21 replacement knobs of asst. colors. net. . \$1.95

Sold at better jobbers everywhere—Detailed literature upon request. Write Dept. P-10
R-COLUMBIA PROD. CO., INC. 2008 St. Johns Ave. Highland Park, Ill.



Duotone needles, of course . . . tipped with genuine diamonds, sapphires or osmium. Most people forget to change their styli or don't know how to change them. Why not suggest a Duotone diamond needle replacement for every phonograph that comes into your shop? It's the stylus with the whole diamond tip that's handset and hand polished. Your customers will appreciate the service and you'll appreciate the increase in business.

Write for Free 1962 Duotone Needle Wall Chart and see DUOTONE Distributor. See us in Room 609A and 611A at Parts Show

DUOTONE
COMPANY, INC. KEYPORT, N. J.

Completely revised, expanded, enlarged . . . the Sixth Edition of
Milton S. Kiver's TELEVISION SIMPLIFIED

The only manual in the field to offer in as compact and easy-to-follow a presentation: • theory and analysis of various stages of a television receiver • television transmitting • servicing receivers.

New chapters, expanded discussions, latest advancements, newest techniques. Over 500 illustrations. An indispensable aid to all who want to understand the basic principles of television and their most recent applications. \$7.50

FREE EXAMINATION COUPON

D. Van Nostrand Company, Inc.
Dept. T-RE 5
120 Alexander Street, Princeton, N. J.

Please send me TELEVISION SIMPLIFIED for ten days' free examination. I will remit \$7.50 plus small delivery cost within ten days or return book and owe nothing.

Name.....
Address.....
City.....Zone.....State.....
SAVE! Remit with order and we pay delivery cost. Same return guarantee.



CONVERT SURPLUS RADIO GEAR INTO USEFUL EQUIPMENT

— 3 volumes give complete conversion data, including instructions, photos and diagrams

SURPLUS RADIO CONVERSION MANUALS — 3 Volumes — \$3.00 ea.

Contain data which has become standard for the most commonly available surplus items. Each conversion shown yields a practical piece of equipment . . . proved by testing.

VOLUME I — ARC-5; BC-221, 224, 312, 342, 348, 412, 453/455, 457/459, 624/625, 645, 696, 946B, 1068A/1161A; PE-103A; SCR-211, 268/271, 274N, 522, 542, TBY; Electronic Surplus Index; Cross Index of A/N V.T. and Commercial Tubes.

VOLUME II — AIC; AM-26; APS-13; ARB (Schematic only); ARC-5; ART-13; ATC; AVT-112A; BC-191, 357, 375, 454-455, 457/459, 946B, 1206; GO-9; LM; R-26-27/ARC-5; R-28/ARC-5; SCR-274N; TA-12B/12C; TBW; T-23/ARC-5; Selenium-Rectifier Power Units; Simplified Coil-Winding Data; Surplus Beam Rotating Mechanisms.

VOLUME III — APN-1; ARC-5; ART-13; BC-191, 312, 342, 348, 375, 442, 453, 455, 456 to 459, 603, 624, 696, 1066, 1253; CBY-52000 series; COL-43065; CRC-7; DM-34D; DY-8 or DY-2A/ARR-2; FT-241A; LM; MBF; MD-7/ARC-5; RM-52, 53; R-9/APN-4; R-28/ARC-5; RT-19/ARC-4; RT-159; SCR-274N series; SCR-508, 522, 528, 538; T-15 to T-23/ARC-5; URC-4; WE-701-A. Schematics only: APA-10; APT-2; APT-5; ARR-2; ASB-5; BC-659; 1335A; CPR-46ACJ.

THE SURPLUS HANDBOOK (Receivers and Transceivers) — \$3.00

VOLUME I — Schematic Diagrams and large photographs only — APN-1; APS-13; ARB; ARC-4; ARC-5 (L.F.); ARC-5 (V.H.F.); ARN-5; ARR-2; ASB-7; BC-222, 312, 314, 342, 344, 348, 603, 611, 624, 652, 654, 659, 669, 683, 728, 745, 764, 779, 794, 923, 1000, 1004, 1066, 1206, 1306, 1335; BC-AR-231; CRC-7; DAK-3; GF-11; Mark II; MN-26; RAK-5; RAL-5; RAX-1; SCR-522; Super Pro; TBY; TCS; Resistor and Capacitor Color Codes; Cross Index of A/N V.T. and Commercial Tubes.



*Order from your favorite electronic parts distributor
If he cannot supply, send us his name and your remittance, and we will supply; foreign, add 10%.

EDITORS and ENGINEERS, Ltd. Summerland 5, California

Dealers: Electronic distributors, order from us. Bookstores, libraries, newsdealers order from Baker & Taylor, Hillside, N.J. Export (exc. Canada), order from H.M. Snyder Co., 440 Park Ave. So., N.Y. 16.



Save 30% on 4-track Stereo Music on Tape!

Empty 3 in. plastic reels 7¢ ea.

BARGAIN PRICES!

SEND FOR OUR FREE

Tape Recorder/Blank/Pre-recorded Tape Catalog
SAXITONE TAPE SALES

(Div. of Commissioned Electronics Co., Inc.)
1776 Columbia Road Washington, D.C.

TAPE RECORDERS



HI-FI COMPONENTS SLEEP LEARN KITS

Unusual Values
Free 1962
Catalog

DRESSNER

1523RE Jericho Tpke, New Hyde Park, N.Y.

MERITAPE
Low cost, high
quality recording
tape, in boxes or cans.

Wiley BOOKS

FUNDAMENTALS OF SEMICONDUCTOR AND TUBE ELECTRONICS

By H. ALEX ROMANOWITZ, *University of Kentucky*. A first look at both tube and semiconductor theory and practice, from the engineering point of view. The book includes also a brief background of physical theory, in order to bring out the *whys* of basic concepts and principles.

Throughout the book quantitative treatment is emphasized, in which qualitative description is combined with mathematical derivations, illustrations and proofs. Semiconductor diodes, transistors, and tubes are studied in closely related, adjacent chapters, and applications follow in a similarly related manner. Includes review questions and over 300 problems. 1962. 620 pages. \$8.25.

Send now for your on-approval copy

JOHN WILEY & SONS, Inc.
440 Park Ave. South, New York 16, N.Y.

Turn ON the QUIET Turn OFF the NOISE with QUIETROLE...

The quality, proved lubricant for effective silencing of noisy controls and switches on TV, radio and electronics instruments. And the FREE EXTENDER TUBE makes those once pesky places easy to reach. Put quality QUIETROLE in your repair kit and see how quickly and easily you satisfy more of your customers.



6 Oz. SPRAY PACK CAN (with FREE Extender Tube)



2, 4, 8 oz. Bottles (with Dropper)

Product of **QUIETROLE COMPANY**
Spartanburg, South Carolina
in Canada: CROSS CANADA ELECTRONICS
12 Laurel Street, Waterloo, Ontario

The 21ZP4-B replaces:
21ZP4 21ZP4-A 21ZP4-B
The 21YP4-A replaces:
21AFP4 21YP4 21YP4-A

8056

A medium-mu triode nuvistor designed for operation from a plate-voltage supply of 12 to 50 volts, in a variety of industrial and commercial equipment. It is especially useful in low-noise rf and if amplifier circuits, control and multivibrator circuits, cathode followers, and any other circuit requiring a device that has a very high input impedance and capable of operating at low supply voltages.

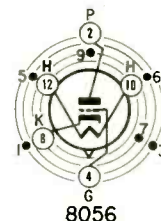
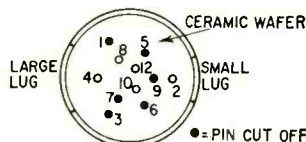
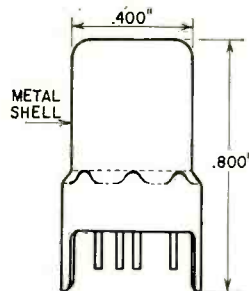

Maximum industrial service ratings for the RCA 8056 are:

V_p	50
V_G (neg bias value)	55
(peak pos value)	2
P_p (watts)	0.45
I_G (ma)	2
I_k (ma)	15

Typical operating characteristics:

V_p (supply)	12	24
V_G (supply)	0	0.7
R_G (k ohms)	33	—
μ	12.5	12.5
R_p (approx k ohms)	1.56	1.56
G_M (μ mhos)	8,000	8,000
I_p (ma)	5.8	10



"Forget the 120-cycle ripple, Sam. She's doing the twist."

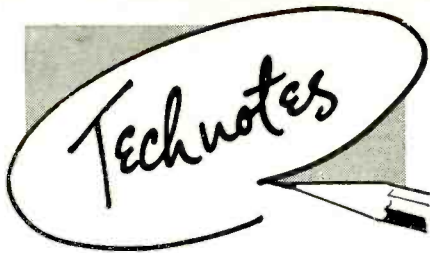

SHIFTING CONVERGENCE

When a color TV receiver is first turned on, the alignment of the gun structure of the picture tube may change slightly because of heating. The normal effect of this heating will vary the static convergence of the receiver, unless some allowance is made for the warmup period. Therefore, it is wise to let the set warm up for about 15 minutes before you converge it. In this way, when the customer turns his set on, instead of it drifting out of convergence, it will drift into convergence.—*RCA Television Service Tips.*

REGENCY TR-1

The set came in with severe audio distortion. We connected a high-impedance headset across the volume control. Sound was satisfactory here. Then we clipped the headset across the base of the audio output transistor to battery positive. Some slight distortion was noted here.

Components in the audio output stage were resistance-checked next. No off-value units were spotted. Voltage tests

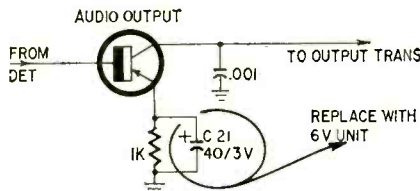

followed and revealed nearly zero voltage on the emitter.

When capacitor C21 (40 μ f at 3 volts) was clipped, voltage on the emitter increased. We replaced the unit with a 6-volt capacitor and had no further trouble.—*Chester S. Lawrence*

HEATH CB TRANSCEIVER

Noting a decided drop in receiver gain when switching from crystal to variable tuning in a Heath GW-10 on the bench, I mistakenly thought the 6C4 oscillator tube was weak. Further troubleshooting turned up an interesting kink. There are two positions of the slug in the oscillator coil which allow tracking of the 22 channels. However, with the adjustment in the lowest position (closest to the chassis),

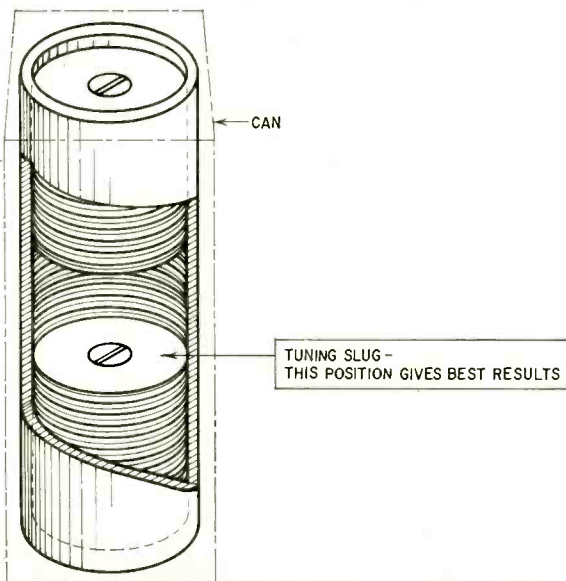

from
THORENS
...the new
BTD-12S Tone Arm

Here's the *first* 12" tone arm to match the wealth of features made available on the now famous Thorens "TD" turntables!

It's the new THORENS BTD-12S Tone Arm. And it's tops because Thorens engineers have thought of *everything*: Lowest possible inertia. Precision ball bearings on all axes. A precision cueing device to set stylus on record or lift it off without damaging grooves.

And adjustments! No other arm has so many! Lateral Balancing: An adjustable damped counterweight balances cartridges weighing 5 to 19 grams. Stylus Force: Spring-applied — making it unnecessary to level turntable — is adjustable by a calibrated knob (0 to 8 grams). Adjustable Stylus Overhang: You can easily set this critical distance for the arms optimum tracking error 0.5°/inch max.) for *every* cartridge with slide in plug-in shell (7/16" range). And Height: There's an adjustment for that (1 5/8" range) *plus* a unique, Thorens designed pivot that keeps stylus in a vertical plane for every setting! Get full details on the unique Thorens BTD-12S tone arm today! *See your franchised Thorens dealer, or write us direct.*

THORENS BTD-12S TONE ARM, supplied on mounting board for Thorens models TD-124 and TD-121 turntables. Can be used on *any* turntable.

Guaranteed for One Full Year. \$50.00 net

THORENS DIVISION
ELPA MARKETING INDUSTRIES, Inc.
New Hyde Park, N. Y.



Modernize Your TV Set

with a
STANDARD NEOTRODE TUNER

Latest 21mc type, replaces CASCODE
PENTODE, Etc. Improves performance. **\$12.97**
Complete with Tubes & Instructions.....

SALE ON TECH-MASTER

CONSTELLATION TV CHASSIS #6115 **\$139.50**
Complete ready to play (less CRT)

DX-16 DELUXE TV KIT

Complete, with Tubes (less CRT)..... **\$93.49**

TV CABINET KIT 21" or 23"

Mahogany, Walnut or Blond..... **\$26.97**

90° TV CONVERSION KIT... \$9.95

#630 TV CHASSIS

(Rebuilt) COMPLETE READY TO OPERATE, including New Westinghouse 21" Alum- **\$79.50**
inized PICTURE TUBE.....

GARRARD "AUTOSLIM" RECORD CHANGER

including \$34.50 AUDIO EMPIRE #108 **\$39.51**
STEREO DIAMOND CARTRIDGE.....

*MONARCH RECORD CHANGER.. **\$17.97** *VM RECORD CHANGER.. **\$21.97** *Dual Sapphire Cartridge Included

HOTTEST

VALUE EVER OFFERED!

\$200.00 HEARING AID (as shown) — Your Price \$2.00



We Scooped the Market on 15000 of these HEARING AIDS from one of the Leading Manufacturers (name withheld) who switched to the Transistor Type.

Each HEARING AID INSTRUMENT is a Complete AUDIO AMPLIFIER and includes—a CRYSTAL MICROPHONE, 3 SUB-MINIATURE TUBES and a Superb Beige Phenolic CABINET.

Indeed a TOP ITEM for the Experimenter—can be modified and converted to: RADIOS—INTERCOMS—TRANSMITTERS—SECRET LISTENING DEVICES—ETC. Also useful as MICROPHONE for Tape Recorders.

5" x 2 1/2" x 1"—Shipping Weight 1 lb.

Complete as illustrated—including a detailed informative **\$2.00**
SCHEMATIC DIAGRAM (less Earphone and Battery).....

Sold without limit or reserve! Order as many as you want! Rush your order!

"ONE DOLLAR" buys

As much as \$15 worth — Everything Brand New and sold to you with a money back guarantee.

10% OFF & FREE GIFT ON PURCHASE OF \$10 OR OVER (ON DOLLAR BUYS)

- | | | | |
|---|---|--|--|
| <ul style="list-style-type: none"> <input type="checkbox"/> \$15.00 RADIO PARTS "JACKPOT" handy assortment \$1 <input type="checkbox"/> 1 - 5" PM SPEAKER alnico #5 magnet \$1 <input type="checkbox"/> 1 - 4" PM SPEAKER alnico #5 magnet \$1 <input type="checkbox"/> 1 - 4" TWEETER SPEAKER for HI-FI \$1 <input type="checkbox"/> 5 - SETS SPEAKER PLUGS male & female, wired, long leads \$1 <input type="checkbox"/> 3 - AUDIO OUTPUT TRANSFORMERS 50L6 type \$1 <input type="checkbox"/> 3 - AUDIO OUTPUT TRANSFORMERS 6K6 or 6V6 type \$1 <input type="checkbox"/> 3 - I.F. COIL TRANSFORMERS 456kc, most popular type \$1 <input type="checkbox"/> 2 - G.E. I.F. COIL TRANSFORMERS 456kc RTL-143 w/flange \$1 <input type="checkbox"/> 3 - I.F. COIL TRANSFORMERS 10.7mc for FM \$1 <input type="checkbox"/> 3 - I.F. COIL TRANSFORMERS 282kc for Auto Radios \$1 <input type="checkbox"/> 4 - OVAL LOOP ANTENNAS assorted popular sizes \$1 <input type="checkbox"/> 6 - VARIABLE CONDENSERS superhet 420/162 mfd \$1 <input type="checkbox"/> 3 - ASST. SIZES RADIO CHASSIS PANS drilled & plated \$1 <input type="checkbox"/> 3 - 1/2 MEG VOLUME CONTROLS with switch \$1 <input type="checkbox"/> 5 - 1/2 MEG VOLUME CONTROLS less switch \$1 <input type="checkbox"/> 5 - ASST. 4 WATT WIREWOUND CONTROLS \$1 <input type="checkbox"/> 10 - ASSORTED VOLUME CONTROLS less switch \$1 <input type="checkbox"/> 5 - ASSORTED VOLUME CONTROLS with switch \$1 <input type="checkbox"/> 10 - SURE-GRIP ALLIGATOR CLIPS 2" plated \$1 <input type="checkbox"/> 1 - GOLD GRILLE CLOTH 14"x14" or 12"x18" \$1 <input type="checkbox"/> 10 - SETS PHONO PLUGS & PIN-JACKS RCA type \$1 <input type="checkbox"/> 100' - FINEST NYLON DIAL CORD best size, .028 gauge \$1 <input type="checkbox"/> 50 - ASST. RADIO KNOBS screw and push-on types \$1 <input type="checkbox"/> 30 - INSTRUMENT POINTER KNOBS popular screw type \$1 | <ul style="list-style-type: none"> <input type="checkbox"/> 300 - ASST 1/2 W RESISTORS AB, IRC, Short leads, excellent \$1 <input type="checkbox"/> 100 - ASSORTED 1/2 WATT RESISTORS some in 5% \$1 <input type="checkbox"/> 70 - ASSORTED 1 WATT RESISTORS some in 5% \$1 <input type="checkbox"/> 35 - ASSORTED 2 WATT RESISTORS some in 5% \$1 <input type="checkbox"/> 40 - ASST. PRECISION RESISTORS in 1 percenters \$1 <input type="checkbox"/> 20 - ASS'TED WIREWOUND RESISTORS 5, 10, 20 watt \$1 <input type="checkbox"/> 50 - ASSORTED TUBULAR CONDENSERS .001 to .47 \$1 <input type="checkbox"/> 50 - ASST. CERAMIC CONDENSERS some in 5% \$1 <input type="checkbox"/> 50 - ASST. MICA CONDENSERS some in 5% \$1 <input type="checkbox"/> 35 - ASST. DISC CERAMIC CONDENSERS popular numbers \$1 <input type="checkbox"/> 35 - DISC CERAMIC CONDENSERS 5000 mmmf \$1 <input type="checkbox"/> 25 - ASSORTED MICA TRIMMER CONDENSERS \$1 <input type="checkbox"/> 20 - TUBULAR CONDENSERS .047-600v \$1 <input type="checkbox"/> 15 - TUBULAR CONDENSERS .01-600v \$1 <input type="checkbox"/> 20 - TUBULAR CONDENSERS .1-600v \$1 <input type="checkbox"/> 3 - ELECTROLYTIC CONDENSERS 50/30-150v \$1 <input type="checkbox"/> 15 - ASST. RADIO ELECTROLYTIC CONDENSERS \$1 <input type="checkbox"/> 10 - ASST. TV ELECTROLYTIC CONDENSERS \$1 <input type="checkbox"/> 3 - ELECTROLYTIC CONDENSERS 40/40-450v \$1 <input type="checkbox"/> 4 - ELECTROLYTIC CONDENSERS 80-400v \$1 <input type="checkbox"/> 20 - ELECTROLYTIC CONDENSERS 2-450v \$1 <input type="checkbox"/> 4 - DIODE CRYSTALS 1-1N34 1-1N90, 1-1N89, 1-1N82 \$1 <input type="checkbox"/> 3 - SELENIUM RECTIFIERS 2 - 65ma and 1 - 75ma \$1 <input type="checkbox"/> 50 - ASSORTED TERMINAL STRIPS 1, 2, 3, 4 lugs \$1 <input type="checkbox"/> 50 - ASSORTED SOCKETS 7 pin, 8 pin, 9 pin \$1 <input type="checkbox"/> 20 - PILOT LIGHT SOCKETS bayonet type, wired \$1 | <ul style="list-style-type: none"> <input type="checkbox"/> 30 - ASST. PILOT LIGHTS #44, 46, 47, 51, etc. \$1 <input type="checkbox"/> 100 - ASSORTED FUSES popular sizes 3AG, 4AG, etc. \$1 <input type="checkbox"/> 10 - ASSORTED TUBES Radio, TV, Industrial \$1 <input type="checkbox"/> 4 - TUNGSOIL 1U4 TUBES also serves as a 1T4 \$1 <input type="checkbox"/> 3 - SYLVANIA 35W4 TUBES factory cartoned \$1 <input type="checkbox"/> 3 - CBS 12AV6 TUBES \$1 <input type="checkbox"/> 2 - RCA 6AC7 TUBES \$1 <input type="checkbox"/> 15 - ASSORTED ROTARY SWITCHES regular \$15 value \$1 <input type="checkbox"/> 10 - 6' ELECTRIC LINE CORDS with plug \$1 <input type="checkbox"/> 4 - 50' SPOOLS HOOK-UP WIRE 4 different colors \$1 <input type="checkbox"/> 32' - TEST PROD WIRE deluxe quality, red or black \$1 <input type="checkbox"/> 50 - STRIPS ASSORTED SPAGHETTI handy sizes \$1 <input type="checkbox"/> 100 - ASSORTED RUBBER GROMMETS best sizes \$1 <input type="checkbox"/> 50' - HI-VOLTAGE WIRE for TV, special circuits, etc. \$1 <input type="checkbox"/> 200' - BUSS WIRE #20 tinned for hookups, special circuits, etc. \$1 <input type="checkbox"/> 250 - ASST. SOLDERING LUGS best types and sizes \$1 <input type="checkbox"/> 1 - LB SPOOL ROSIN-CORE SOLDER 40/60 \$1 <input type="checkbox"/> 200 - ASST. SELF TAPPING SCREWS #6, #8, etc. \$1 <input type="checkbox"/> 150 - ASST. 6/32 SCREWS & 150 - 6/32 HEX NUTS \$1 <input type="checkbox"/> 150 - ASST. 8/32 SCREWS & 150 - 8/32 HEX NUTS \$1 <input type="checkbox"/> 100 - ASST. RUBBER FEET FOR CABINETS best sizes \$1 <input type="checkbox"/> 8 - ASST. LUCITE CASES hinged cover, handy for parts \$1 <input type="checkbox"/> 4 - TOGGLE SWITCHES SPST, SPDT, DPST, DPDT \$1 <input type="checkbox"/> 35 - CERAMIC CONDENSERS 20-250mmf & 15-470mmf \$1 <input type="checkbox"/> 35 - CERAMIC CONDENSERS 20-1000mmf & 15-1500mmf \$1 <input type="checkbox"/> 35 - CERAMIC CONDENSERS 20-2000mmf & 15-5000mmf \$1 | <ul style="list-style-type: none"> <input type="checkbox"/> \$15.00 TELEVISION PARTS "JACKPOT" best buy ever \$1 <input type="checkbox"/> 1000 - ASST HARDWARE KIT screws, nuts, washers, rivets, etc. \$1 <input type="checkbox"/> 5 - 9 V RADIO BATTERIES similar to Eveready #216 \$1 <input type="checkbox"/> 50 - ASSORTED TV COILS sync, peaking, width, ratio, etc. \$1 <input type="checkbox"/> 1 - \$10 INDOOR TV ANTENNA hi-gain, 3 section, tiltproof \$1 <input type="checkbox"/> 5 - TV CHEATER CORDS with both plugs \$1 <input type="checkbox"/> 100' - TWIN TV LEAD-IN WIRE 300 ohm, heavy duty \$1 <input type="checkbox"/> 50' - FLAT 4-CONDUCTOR WIRE many purposes \$1 <input type="checkbox"/> 20 - ASSORTED TV KNOBS ESCUTCHEONS, \$20 value \$1 <input type="checkbox"/> 6 - ASSORTED STANDARD TUNER UHF STRIPS \$1 <input type="checkbox"/> 1 - 90° FLYBACK TRANSFORMER incl. Schematic Diagram \$1 <input type="checkbox"/> 1 - TV VERTICAL OUTPUT TRANSFORMER 10 to 1 ratio \$1 <input type="checkbox"/> 2 - TV RATIO DETECTOR COILS 4.5mc or 10.7mc \$1 <input type="checkbox"/> 2 - TV SOUND I.F. COILS 4.5mc or 21.25mc \$1 <input type="checkbox"/> 50 - ASSORTED TV PEAKING COILS all popular types \$1 <input type="checkbox"/> 50 - TV R.F. CHOKES standard 5 mh type \$1 <input type="checkbox"/> 4 - ASST. TV ION TRAPS for all type TV Receivers \$1 <input type="checkbox"/> 2 - SILICON RECTIFIERS 500ma, 400PIV \$1 <input type="checkbox"/> 5 - TV PICTURE TUBE SOCKETS wired with 20" lead \$1 <input type="checkbox"/> 5 - TV HI-VOLT ANODE LEADS 20" length \$1 <input type="checkbox"/> 3 - TV ALIGNMENT TOOLS Assortment #1 \$1 <input type="checkbox"/> 3 - TV ALIGNMENT TOOLS Assortment #2 \$1 <input type="checkbox"/> 3 - TV ALIGNMENT TOOLS Assortment #3 \$1 <input type="checkbox"/> 3 - TV ALIGNMENT TOOLS Assortment #4 \$1 <input type="checkbox"/> 3 - TV ALIGNMENT TOOLS Assortment #5 \$1 |
|---|---|--|--|

HANDY WAY TO ORDER — Simply pencil mark items wanted (X in square is sufficient), enclose with money order or check. You will receive a new copy of these offers for re-orders.

ON SMALL ORDERS — Include stamps for postage, excess refunded. **LARGER ORDERS** shipped express charges collect.

BROOKS RADIO & TV CORP., 84 Vesey St., Dept. A, New York 7, N. Y. TELEPHONE CORland 7-2359

the injection signal from the variable oscillator is much stronger than when it is set closer to the top. This results in a 50% or better gain in reception, raising the level of the variable receiver to that of the lock-in. Subsequently I have run across a relatively large number of GW-10's with this same complaint. Screwing this slug into the lower position cured every one.

Another suggestion while on the subject of alignment. An ordinary signal generator will not give a precise enough alignment of the 455-kc if strip. It is best to use the signal from an accurately calibrated source, such as the Lampkin frequency meter. Using an attenuated signal from another CB transmitter is an alternate but less reliable method.—*Charles B. Randall*

RCA 21D305

The complaint was intermittent black horizontal bars. The sync would lose control or the picture would pull whenever the bars appeared. The trouble was located by a long

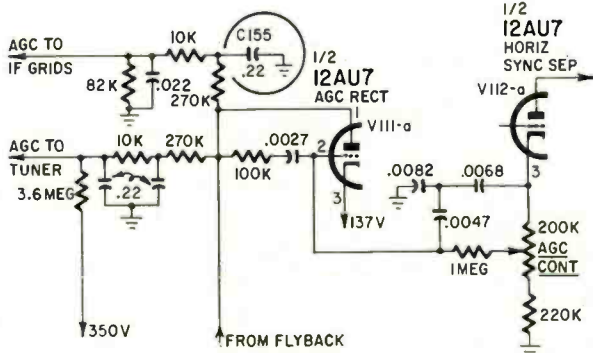

process of shunting suspected capacitors with known good units. This showed that age capacitor C155 (0.22 μ f) was intermittent. A quick replacement was the cure.—*Chester S. Lawrence*

POWER SUPPLIES FOR TRANSISTOR DEVICES

Commercial power supplies often use a resistance to drop the voltage for the lower output ranges. The low-voltage taps may not be bypassed enough to allow the ac signal to return to chassis. When this kind of supply is used to power a transistor set, audio distortion may arise which is not caused by a circuit fault.

When operating from a low-voltage tap on such a test supply, shunt the output to the radio with a capacitor. Use a 25- μ f unit rated at a greater voltage than delivered by the power unit.—*Joe Shane*

AUTOMATIC SEARCH TUNER STALLING

Automatic signal-searching tuners in car radios sometimes stop for no apparent reason when they reach the low end of the band. The actuator bar has to be pushed again to restart it.

When this happens, try the search with the antenna pushed down. If it does not stop now, the search mechanism is OK. Do not alter the sensitivity of the search unit. The problem is caused by the if acting as a station signal at high settings of the sensitivity control in strong station areas. A touch up of the i.f. will usually fix things up; the i.f. may be tuned a trifle too broad.—*Mark Sturgeon* END

WE BUY INDUSTRIAL TECHNOTES

RADIO-ELECTRONICS wants Industrial Technotes. These should cover equipment (including closed-circuit television) actually used in industrial work, or technotes on counters, controls and other apparatus whose users are largely industrial. Unillustrated Technotes pay \$5; circuit diagrams raise the price to \$9 and acceptable photos are worth \$7 each. Send your technotes from industry to Technotes Editor, RADIO-ELECTRONICS, 154 W. 14th St., New York 11, N. Y.

TV-RADIO Servicemen or Beginners...

Send for *Coyne's* 7-Volume Job-Training Set on 7-Day **FREE TRIAL!**

Answers ALL Servicing Problems QUICKLY... Makes You Worth More On The Job!

Put money-making, time-saving TV-RADIO-ELECTRONICS know-how at your fingertips—examine Coyne's all-new 7-Volume TV-RADIO-ELECTRONICS Reference Set for 7 days at our expense! Shows you the way to easier TV-Radio repair—time saving, practical working knowledge that helps you get the BIG money! How to install, service and align ALL radio and TV sets, even color-TV, UHF, FM and transistorized equipment. New photo-instruction shows you what makes equipment "tick". No complicated math or theory—just practical facts you can put to use immediately right in the shop, or for ready reference at home. Over 3000 pages; 1200 diagrams; 10,000 facts!

SEND NO MONEY! Just mail coupon for 7-Volume TV-Radio Set on 7-Day FREE TRIAL! We'll include the FREE BOOK below. If you keep the set, pay only \$3 in 7 days and \$3 per month until \$27.25 plus postage is paid. Cash price only \$24.95. Or return set at our expense in 7 days and owe nothing. Either way, the FREE BOOK is yours to keep. Offer limited, so act NOW!

"LEARNED MORE FROM THEM THAN FROM 5 YEARS WORK!"

"Learned more from your first two volumes than from 5 years work."
—Guy Bliss, New York

"Swell set for either the serviceman or the beginner. Every service bench should have one."
—Melvin Masbruch, Iowa.

FREE DIAGRAM BOOK!

We'll send you this big book, "150 Radio-Television Picture Patterns and Diagrams Explained" ABSOLUTELY FREE just for examining Coyne's 7-Volume Shop Library on 7-Day FREE TRIAL! Shows how to cut servicing time by reading picture-patterns, plus schematic diagrams for many TV and radio sets. Yours FREE whether you keep the 7-Volume Set or not! Mail coupon TODAY!



The First Practical TV-RADIO-ELECTRONICS Shop Library!

Like Having An Electronics Expert Right At Your Side!

- VOL. 1—EVERYTHING ON TV-RADIO PRINCIPLES! 300 pages of practical explanations; hundreds of illustrations.
- VOL. 2—EVERYTHING ON TV-RADIO-FM RECEIVERS; 403 pages; fully illustrated.
- VOL. 3—EVERYTHING ON TV-RADIO CIRCUITS! 336 pages; hundreds of illustrations, circuit diagrams.
- VOL. 4—EVERYTHING ON SERVICING INSTRUMENTS! How they work, how to use them. 368 pages; illustrated.
- VOL. 5—EVERYTHING ON TV TROUBLESHOOTING! Covers all types of sets. 437 pages; illustrations, diagrams.
- VOL. 6—TV CYCLOPEDIA! Quick and concise answers to TV problems in alphabetical order, including UHF, Color TV and Transistors; 868 pages.
- VOL. 7—TRANSISTOR CIRCUIT HANDBOOK! Practical Reference covering Transistor Applications; over 200 Circuit Diagrams; 410 pages.

ALL 7 BOOKS HAVE BRIGHT, MODERN, VINYL CLOTH WASHABLE COVERS

FREE BOOK—FREE TRIAL COUPON!

Educational Book Publishing Division
COYNE ELECTRICAL SCHOOL
1455 W. Congress Parkway, Dept. 52-RE, Chicago 7, Illinois

Yes! Send me COYNE'S 7-Volume Applied Practical TV-RADIO-ELECTRONICS Set for 7-Days FREE TRIAL per your offer. Include "Patterns & Diagrams" book FREE!

Name _____ Age _____
Address _____
City _____ Zone _____ State _____

Check here if you want Set sent C.O.D. Coyne pays postage on C.O.D. and cash orders. 7-Day Money-Back Guarantee.



Coyne

ELECTRICAL SCHOOL
1455 W. Congress Parkway
Dept. 52-RE, Chicago 7, Illinois

"TAB" TUBES

Six Months Guarantee! No Rejects!
NEW & Used Gov't & Mfrs. Surplus!

Orders \$10 or more, Receiving tubes only ppd. 48 states

0A2	.80	8B16	.69	12AT6	.59	18S1	1.00
0B2	.85	8B17	.78	12A7	.84	117Z6	1.10
0C3	.69	8B17	1.25	12A6	.69	4-65A	16.00
0D3	.35	8B16	.98	12A7	.69	2D21	2/81
0Z4	.59	8B06	1.19	12AK7	.79	8D23	3.85
1B3	.78	8B27	1.25	12BA6	.65	717A	3/81
1R5	.78	8C4	.43	12BA7	.99	4-125	20.00
1S4	.78	8CB6	.80	12BE6	.59	4-250	35.00
1T4	.78	8CD6	1.49	12BF6	.59	4PR60	39.50
1U5	.73	8H6	5/81	Send See for Catalog	.99	1X250	35.00
1X2A	1.99	6J5	.52	12B7	.98	1Y500	38.00
3Q5	.80	6J8	.48	12B7	.99	58P4	Querv
3S4	.68	6L6	.59	12SA7	.84	35T	4.00
3V4	.83	6S4	.59	12S07	.89	100T	7.00
5R4	.88	6S8	.99	12S17	.89	316A	5/81
5U4	.80	6SA7	.69	12SK7	.94	388A	3/81
5V4	.80	6SB7	1.19	12SQ7	.84	4168	4.00
5Y3	.59	6SC7	.89	19B66	2.15	150T	42.00
6AC7	.70	6SG7	.79	25BQ6	1.39	907	1.00
6AK5	.69	6SK7	.69	25L6	.69	866A	1.89
6AL5	2/81	6SL7	.85	25W4	.77	811	4.40
6AG5	3.00	6SN7	2/81	25Z6	.75	814	3.45
6AS7	.49	6T8	.98	35L6	.69	829B	8.00

TUBES WANTED! WE BUY! SELL & TRADE!

GTI! Octal Silicon-5U4G—Tube Replacement
1120Rms 1600Piv \$7 @ 2 for \$6; 4 for \$10
5R4 Silicon 1900/2800Piv \$4
866A Silicon 5000/10400Piv \$9

"TAB" FOR TRANSISTORS & DIODES!!!
Full Length Leads U.S.A. Mfg.

Factory Tested & GTD
PNP Hi Power 15 Amp, TO3 & TO36 Pckg.
2N441, 2N277 \$1.25 @ 10 for \$11
2N442, 2N278 \$3 @ 2N443, 2N174 \$4 @ 2
2N677 \$1 @ 2N677A \$2 @ 2N677B
53 @ 2N677C \$5 @ 3
3 Amp, 2N155, 2N156, 2N255, 2N256,
2N507, 2N555, TO3GP, 49 15W4, for \$2;
PNP 2N123, 2N107, CK722, for \$1; NPN 2N292,
293; PNP 2N223 \$3 @ 12 for \$9, 100 for \$65;
PNP 2N670/300MW \$5 @ 10 for \$4
PP 2N671/1 Watt c75 @ 10 for \$4
Round or Diamond Base Mica Mtd Kit \$30 @,
Power Heat Sink Fins 80 Sq \$1.39
Kit Glass Diodes equiv. 1N34A, 46, 48, 51,
12 for \$1, 100 for \$6, 1000 for \$50

ZENER DIODES 150to400 Mw Cased TO24Pckg
Within 20% V Range \$1 @ 3 for \$2; 20for \$10
KIT ZENER DIODES up to 400MW SINGLE &
DOUBLE ENDED ZENER DIODES 2for \$1

"TAB", SILICON 750MA * DIODES
NEWEST TYPE! LOW LEAKAGE
D.C. or Battery. Derate 20%

rms/piv 35/50 .09	rms/piv 70/100 .17	rms/piv 140/200 .22	rms/piv 210/300 .31
rms/piv 280/400 .38	rms/piv 350/500 .50	rms/piv 420/600 .63	rms/piv 490/700 .77
rms/piv 560/800 .83	rms/piv 630/1000 1.08	rms/piv 700/1100 1.35	rms/piv 770/1100 1.60

Diode order \$10 shipped Post free

Low Priced T300 Silicon Diodes
Rated 400piv/280rms@300Ma@100°C
.25 each; 30 for \$7; 100 for \$22; 500 for \$100

SILICON POWER DIODE STUDS*
Operation Up to 125°C, Case Temp.

D.C. Amps	50Piv 35Rms	100Piv 70Rms	150Piv 105Rms	200Piv 140Rms
2	.35	.45	.55	.65
3	.50	.65	.80	1.00
6	1.00	1.30	1.60	2.00
12	1.75	2.25	2.75	3.50
35	4.50	5.75	7.00	8.75
70	9.00	11.50	14.00	17.50
240	27.00	34.50	42.00	52.50

D.C. Amps	300Piv 210Rms	400Piv 280Rms	500Piv 350Rms	600Piv 420Rms
2	.80	1.00	1.50	1.95
3	1.50	2.00	2.10	2.65
6	1.75	2.00	3.70	5.20
12	2.00	2.20	3.90	5.70
35	4.95	6.10	7.25	8.40
70	10.80	15.30	19.80	24.30
240	19.60	29.75	39.90	49.05

FOR QUANTITY
Export & User Prices
Write on Company
Letterhead

*Derate 20% for Battery or Capacitive Load or
D.C. Blocking! *Stud mounted on Heat-sink.

TWO 866A's and FILAMENT \$6
XFMR 10 Kv Insult SPECIAL!

NEW BATTERY CHARGER BC612X
For 6 or 12 Volt Batteries
Trickle & Full Charge up to 10 amps
Charges 6 & 12 volt batteries
Built ready to use BC612X @ \$14.00
BC612B up to 2 amps. \$7.45

D.C. POWER SUPPLY 115V/60to800Cys Inpt.
330&165VDC up to 150MA. CASED! SPECIAL \$5

TRANSISTOR POWER CONVERTER
12VDC to 500VDC up to 200MA
100 Watts Tap at 250VDC
DB500 \$33
12VDC to 250VDC up to 150MA
Type C1225E \$30

"SUPERIOR" Powerstat #10 Variable X FMR
165 Watt 0 to 132V Special \$6 each, 2 for \$10

"TAB" TERMS: Money Back Guarantee
Our 18th year. \$2 min. order
F.O.B. N.Y.C. Add shpg charges
or for C.O.D. 25% Dep. Prices
shown subject to change.
111-GE Liberty St., N.Y.C. 6, N.Y.
Send 25¢ for Catalog
PHONE: RECTOR 2-6245

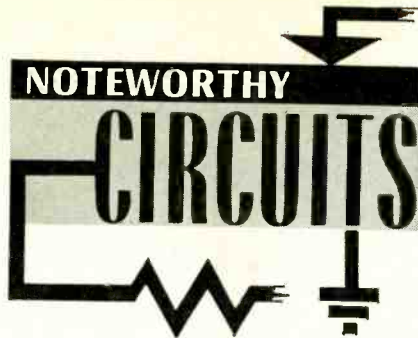

TESTER FOR INTERMITTENT HEATERS

An intermittent heater in a series-string circuit can be a real time waster if the defective heater stays open for only a few seconds, as sometimes happens. The foolproof tester in the diagram can be made up for about \$1 or so. It consists of a number (any number) of neon lamps with series-limiting resistors—one for each heater in the set. Miniature clips connect to the junction between tube heaters in the same series sequence across corresponding unused lamps if you have more lamps than tubes.

Check operation by removing the tubes from the radio, one by one, to see that each neon lamp lights when its corresponding tube is removed. When they are OK, their low resistance across the individual lamps prevents any lamp from lighting. When the defective heater

opens, the lamp across it receives the full line voltage and lights up.

Another way to tackle this problem is to make up the tester for use independent of the radio. Mount tube

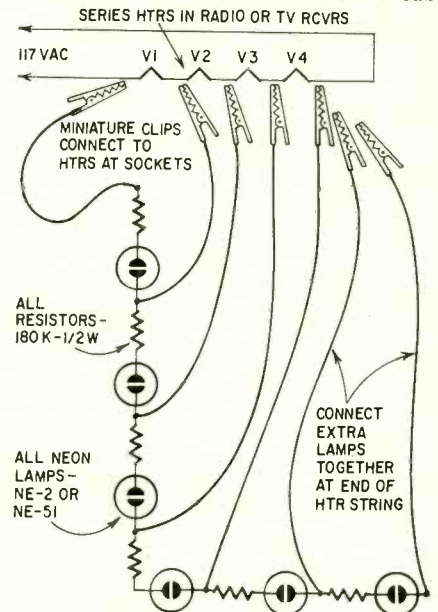

sockets in the chassis with the heaters connected across the neon lamps. A seven- and nine-pin miniature and an octal socket in parallel at each lamp position will take care of nearly all tubes. The 117-volt ac line is connected across the entire string. Now the tubes are removed from the radio and plugged into the sockets, and an inexpensive spst slide switch across each position

Superior's New Model 820

TUBE TESTER

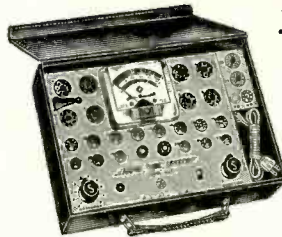

TESTS ALL MODERN TUBES
INCLUDING THE NEW

- ✓ NOVARS
- ✓ NUVISTORS
- ✓ 10 PINS
- ✓ 12 PIN COMPACTRONS

- Employs new improved emission circuit.
- Tests over 850 tube types.
- Tests 0Z4 and other gas filled tubes.
- Employs new 4" meter with sealed air-damping chamber resulting in accurate vibrationless readings.
- Use of 26 sockets permits testing all popular tube types.
- Dual Scale meter permits testing of low current tubes.
- 7 and 9 pin straighteners mounted on panel.
- All sections of multi-element tubes tested simultaneously.
- Ultra-sensitive leakage test circuit will indicate leakage up to 5 megohms.

Model 820 comes complete with tube charts and instructions; \$3850 housed in handsome, portable, Saddle-Stitched Texon case. Only

**SHIPPED ON APPROVAL
NO MONEY WITH ORDER - NO C.O.D.**

Try it for 15 days before you buy. If completely satisfied then send \$5.00 and pay balance at rate of \$5.00 per month until total price of \$38.50 (plus postage) is paid - No Interest or Finance Charges Added! If not completely satisfied, return to us, no explanation necessary.

MOSS ELECTRONIC, INC.
DEPT. D-930, 3849 Tenth Ave., New York 34, N.Y.
Please rush Model 820. If satisfactory, I will pay on terms specified. Otherwise I will return test.
Name _____
Address _____
City _____ Zone _____ State _____
All prices net. F.O.B., N.Y.C.

See page 89 for complete details about the Gernsback Technicians' Book Club Plan.

Gernsback Library, Inc.
154 West 14th St.
New York 11, New York

will permit shorting out any unused sockets.

Whichever way you build it, this tester won't be used very often but, when you need it, it will be worth far more than the small amount of time and money that you put in it.—James E. Pugh, Jr.

NOVEL NONPOLARIZED ELECTROLYTICS

We occasionally need a nonpolarized capacitor with fairly high voltage and capacitance ratings for a circuit where voltage polarity is reversible. When the required capacitor is unavailable or takes too much space, this trick works nicely in many applications. The space required is a fraction of that needed for a nonpolarized component.

Take two ordinary electrolytics with the required voltage and capacitance ratings. Connect them back to

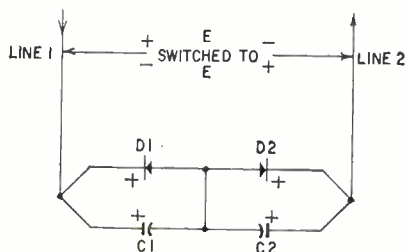

back and shunt each with a rectifier diode as shown. When line 1 is positive, D1 blocks while D2 conducts to short out C2. When line 2 is positive, D2 blocks and D1 conducts, thus leaving only C2 in the circuit.

The piv rating of the diodes must be higher than the maximum working voltage. Their current ratings must be higher than the surge current if sudden polarity reversals are expected.—John H. Hughes, Jr.

EXPERIMENTER'S POWER SUPPLY

Occasionally a service technician or experimenter requires a voltage higher than his bench supply delivers. This simple circuit modification, taken from *The Radio Constructor* (London, England), shows how a simple dpdt switch can be added to double a typical supply's output voltage. Figs. 1 and 2 show modifications for semiconductor and vacuum-tube rectifier, respectively.

When the switch is in the NORMAL position, the power supply uses conven-

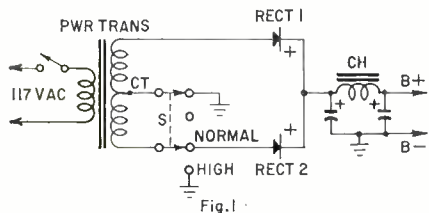

tional full-wave rectification and delivers a dc voltage equal to around half the transformer's rms secondary voltage. In the HIGH position, the circuit is converted to a half-wave rectifier delivering twice the voltage at half the rated current.

Now... Tomorrow and for years to come!

Sonar CITIZENS BAND RADIO

- 8 Channels, crystal controlled transmitter and receiver
- Tunable receiver for 22 channels
- Transmitter 100% Class B modulated
- Adjustable squelch
- Automatic noise limiter
- R. F. Power indicator
- 1 Year guarantee
- Easy to install. Ideal for home, boat, car or business. Weighs only 9 lbs. . . 4¾ x 9½ x 11¼
- FCC Type accepted*

*in preference to only certification with 1 pair of crystals, microphone and power cables

\$179⁵⁰



Sonar
RADIO CORPORATION

73 Wortman Ave., Brooklyn 7, N.Y.

Please send me complete information on Model "E" CB Radio.

Dept. 124

NAME _____

ADDRESS _____

CITY _____

STATE _____

PHOTOGRAPHS

RADIO-ELECTRONICS can use good photographs of service benches, service shops, high-fidelity audio layouts, and any other interesting and original radio-electronic devices. We will pay \$10 each for good professional photos or equivalent, suitable for reproduction. Full information on subject photographed will increase their acceptability.

The Editor, RADIO-ELECTRONICS 154 West 14th St. New York 11, N. Y.



INJECTORALL

THE NEEDLE DOES THE JOB!



TUNER CLEANER AND LUBRICANT
with...
INJECTOR NEEDLE

The leak-proof steel Injectorall Needle lubricates where you need it... you can reach hard-to-get at Wafers without pulling Tuners apart, or even removing Chassis.

The BEST CLEANER on the market today!

INJECTORALL CO. Brooklyn 14, New York

AMAZING

TV LIFE-SAVER®

ONLY **\$4.95**



U.S. Pat. 2,914,637

Eliminates Costly TV Troubles

By absorbing damaging in-rush current so destructive to Television and Hi-Fi tubes, the TV LIFE-SAVER eliminates 3 out of 4 Service calls by more than tripling the life of all tubes...

PROTECTION



Model 4100-2, 100-275 watts 117 V. **\$1.95** List
Model 8050-4, 250-400 watts 117 V. **\$2.95** List

WUERTH SURGISTOR®

A new component easily installed to reduce call-backs by eliminating surge current damage to television and Hi-Fi tubes.

See your dealer or distributor today for these money saving, equipment saving Miracle Inventions. Or, send your order direct to us for prompt action.

WUERTH PRODUCTS CORP.
1931 Moffet St., Hollywood, Florida

INTERESTED IN

- KIT BUILDING
- SERVICE SHOP HINTS
- A FUTURE IN COMPUTERS?

read these new RIDER BOOKS

HOW TO BUILD ELECTRONIC EQUIPMENT by J. Richard Johnson. Covers all the situations you'll ever face in building electronic equipment. This book will save you money because you'll avoid many common mistakes made in building equipment. It'll save you time by providing practical tips on how to layout the chassis and how to use the tools and materials available. And—it will add to your pleasure because the finished equipment will perform the way it was designed to. Hundreds of down-to-earth ideas make this book indispensable to the kit builder, the newcomer and the experienced "pro" who builds equipment from "scratch". #286, hard cover, \$6.95.

USEFUL ELECTRONIC SHOP HINTS edited by the staff of *Electronic Technician Magazine*. Crammed full of practical, helpful and time-saving shop hints. A collection of nearly 200 of the best electronic shop hints which have appeared in *Electronic Technician Magazine* since 1953. Selections made by the magazine's staff, originally resulted from reader contributions. Many are illustrated. The book presents a wide number of shop hints in these areas: Tools, TV and Radio, Cheater Cords, Components, Soldering, Testing Aids, Audio, and CRT's. #295, \$1.95.

COMPUTER ARITHMETIC by Henry Jacobowitz. Computer arithmetic differs from conventional arithmetic. This book describes binary and other arithmetic systems currently used to feed information into digital computers. It will make the fundamentals of these arithmetics completely understandable to those in the computer field and those who wish to enter it. It teaches the operations of all positional number systems—the decimal, the binary, as well as other number systems that have found and are likely to find applications in computers. #297, \$3.00.

COMMUNICATIONS DICTIONARY by James F. Holmes, P. E. Indispensable, compact, inexpensive—this remarkable reference defines more than 2500 terms in the telecommunications and data processing fields. A must for anybody in telecommunications—radio, television, telemetry, facsimile, etc.—and data processing. #301, \$1.50.

BASIC PRINCIPLES & APPLICATIONS OF RELAYS by Harvey Pollack. A lucid introduction to the construction, operation and application of relays. The book starts by discussing relay components—including coils and contacts—in terms of their individual functions. DC relays, their rectifier arrangements, selected circuits, and contact protection are covered. The chapter on electronic relay circuits shows a number of thyatron circuits together with various light-operated, cold cathode and combination relays. Time delay relay circuits are discussed with practical applications. The chapter on relay selection explains the factors governing the choice of a particular relay for a specific circuit. #250-1, \$2.90.

Mail to your distributor, bookstore or order direct:

ORDER TODAY—10-DAY GUARANTEE

JOHN F. RIDER PUBLISHER, INC. Dept. RE-5
(Rider Division of Hayden Publishing Co., Inc.)
116 West 14th Street, New York 11, New York

I have enclosed \$_____ please send:

- How To Build Electronic Equipment, \$6.95.
- Useful Electronic Shop Hints, \$1.95.
- Computer Arithmetic, \$3.00.
- Communications Dictionary, \$1.50.
- Basic Principles & Applications of Relays, \$2.90.

Name _____

Address _____

City _____ Zone _____ State _____

Satisfaction guaranteed, or I can return within 10 days of purchase for full refund.

In Fig. 1, RECT 1 should be able to operate at an rms voltage equal or higher than the total voltage across the transformer's secondary. Therefore you must replace RECT 1 with a type with higher rms and piv ratings. Similarly, do not exceed the voltage rating of the upper diode of the tube in Fig. 2. With

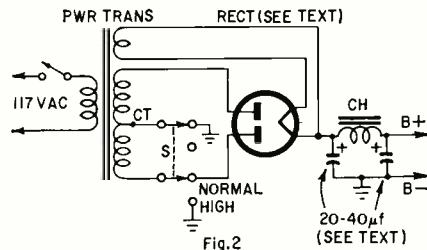

capacitor-input filter and a medium-power rectifier such as a 5Y3, 5Y4 or 5V4, the full secondary voltage should not exceed 350. Use a 5U4-G for voltage up to 500 and a 5R4-GY for 700 to 900 volts rms. Use filter capacitors with double the normal voltage rating. END

50 Years Ago

In Gernsback Publications

HUGO GERNSBACK, Founder

Modern Electrics.....	1908
Wireless Association of America.....	1908
Electrical Experimenter.....	1913
Radio News.....	1919
Science & Invention.....	1920
Practical Electrics.....	1921
Television.....	1927
Radio-Craft.....	1929
Short-Wave Craft.....	1930
Television News.....	1931

Some larger libraries still have copies of Modern Electrics on file for interested readers.

In May, 1912, Modern Electrics

- A New Pattern Variometer, by R. E. Stark.
- Gernsback Rotary Variable Condenser.
- Bourne Wireless Bill.
- Smith Wireless Bill.
- An Adjustable Tesla Coil, by Moore Stuart.
- Radio Communication.
- Construction of a Rotary Variable Condenser, by B. F. Dashiell.
- Circular Potentiometer, by Sidney E. Anderson.
- Telephone Relay, by De Los Hammers.

SILICON RECTIFIERS 750 MA TOP-HATS

Factory Direct MFG. PRICES

Low leakage Newest Type			
PIV/RMS 50/35 .07 ea.	PIV/RMS 100/70 .15 ea.	PIV/RMS 200/140 .20 ea.	PIV/RMS 300/210 .29 ea.
PIV/RMS 400/280 .35 ea.	PIV/RMS 800/350 .45 ea.	PIV/RMS 600/420 .55 ea.	PIV/RMS 700/490 .70 ea.
PIV/RMS 800/560 .75 ea.	PIV/RMS 900/630 .90 ea.	PIV/RMS 1000/700 1.00 ea.	PIV/RMS 1100/770 1.20 ea.

General Purpose 400PIV at 300MA
Special 2 for .50 25 for 6.00
100 for 20.00

100 Different prec. res., 1/2 W, 1 W, 2 W
of 1/2%, 1% Tolerance..... Only \$1.25
General Electric 1N91 Power Junction
Diode.....10 for \$1.00
Int. Rect. Selenium PIV440/RMS160
DC Current 10MA.....10 for \$1.00

PIV	Current	Price	PIV	Current	Price
200	2 Amps	.50	400	15 Amps	2.18
400	2 Amps	.85	50	50 Amps	2.40
100	15 Amps	1.20	100	50 Amps	3.15
200	15 Amps	1.65	200	50 Amps	4.10

All material guaranteed. \$2.00 min. order. Orders F.O.B. NYC. Include check or money order. Shpg. charges plus. C.O.D. orders 25% down.

WARREN ELECTRONICS CO.

NYC 7, NY 87 Chambers St. WO 2-5727

SCHOOL DIRECTORY



Engineering Technician
A.S. Degree—2 Years
Electronics Engineer
B.S. Degree—4 Years
Write for Folder

ELECTRONIC TECHNICAL INSTITUTE
970 West Manchester Ave., Inglewood, Calif.
4863 El Cajon Blvd., San Diego, Calif.

GET INTO ELECTRONICS

V.T.I. training leads to success as technicians, field engineers, specialists in communications, guided missiles, computers, radar and automation. Basic & advanced courses in theory & laboratory. Electronic Engineering Technology an ECET accredited Technical Institute curriculum. Assoc. degree in 28 mos. B.S. also obtainable. G.I. approved. Graduates in all branches of electronics with major companies. Start Sept., Feb. Dorms, campus. High school graduate or equivalent. Catalog.

VALPARAISO TECHNICAL INSTITUTE

Dept. C Valparaiso, Indiana



LEARN RADAR MICROWAVES COMPUTERS—TRANSMITTERS CODE • TV • RADIO

Phila. Wireless Technical Inst.
1533 Pine St., Philadelphia 2, Pa.
A Non-Profit Corp.
Founded in 1908
Write for Free Catalog to Dept. RE-5
Classes now forming

ENGINEERING EDUCATION for the Space Age

NORTHROP INSTITUTE of Technology is a privately endowed, nonprofit college of engineering offering a complete Bachelor of Science Degree Program and TWO-YEAR accredited technical institute curricula. Students from 50 states, many foreign countries. Outstandingly successful graduates employed in aeronautics, electronics, and space technology. Write today for catalog—no obligation.

NORTHROP INSTITUTE OF TECHNOLOGY
1181 West Arbor Vitae Street, Inglewood 1, California



"Are you sure this ain't fixed?"

RADIO-ELECTRONICS

SCHOOL DIRECTORY

GET YOUR FIRST CLASS F.C.C. LICENSE IN HOLLYWOOD IN SIX WEEKS!

We are specialists in F.C.C. license preparation—we do nothing else. We prepare you for your first class commercial license in six weeks, through intensive full-time teaching and coaching. Our classes are small and meet for 8 hours a day, with maximum personal instruction by a superior teacher. One low tuition covers everything until your F.C.C. license is secured. Write for free details.

Pathfinder School, Dept. E-24
Suite 216
5504 Hollywood Blvd., Hollywood 28, Calif.

LEARN ELECTRONIC ORGAN SERVICING

This new, high paying profession can now be learned easily in your spare time.

- ★ Complete Training—All Makes and Models
- ★ Scientific Teaching Aids Make Learning Easy
- ★ No Prior Knowledge of Electronics Necessary

GET FULL DETAILS ON THIS AMAZING COURSE
WRITE FOR FREE BOOKLET

NILES BRYANT SCHOOL
Dept. L, 3731 Stockton Blvd.
Sacramento 20, California

college degree in 27 months

Higher income . . . advancement. Major corporations regularly interview seniors. **B.S. DEGREE IN 27 MONTHS** in Engineering. **IN 36 MONTHS** in Business Administration. Small classes. Well-equipped labs. *Low costs.* Enter June, Sept., Jan., Mar. Write **J. G. McCarthy** for Catalog and Career Book.

TRI-STATE COLLEGE
2452 College Avenue • Angola, Indiana

B. S. DEGREE IN 36 MONTHS

INDUSTRY & GOVERNMENT NEED 50,000 NEW ENGINEERS A YEAR!
Accelerated year-round program puts you in the job-market a whole year early! Also B.E. degree in 27 mos. Aero., Chemical, Civil, Electrical, Mechanical, Electronics; Math, Chemistry, Physics. Quality instruction; widely recognized. Graduates employed from coast to coast. Self-help program. Modest rate. Start June, July, Sept., Jan., Mar. Catalog: 1552 E. Washington Blvd., Ft. Wayne 2, Ind.

INDIANA TECHNICAL COLLEGE

Learn Mathematics

Today, to get ahead as a technical man, you must understand basic mathematics—logarithms, slide rule, algebraic notation and laws, algebraic functions, linear equations, quadratic equations, higher degree equations, applied geometry, applied trigonometry, progressions and series, transcendental equations, empirical equations, etc.

Grantham School has just recently developed an unusual home study course which can bring you up to date in these subjects.

Don't let inadequacy in math hold you back. Write for details today.

GRANTHAM SCHOOLS, INC.
For details, write: Dept. 240-E
1505 N. Western Ave. Los Angeles 27, Calif.

ENGINEERING DEGREES



E. E.
Option Electronics,
Mechanical,
Also in Liberal Arts
earned by
HOME STUDY
Resident Classes Also
Available if Desired
Specify course preferred
**PACIFIC INTERNATIONAL
COLLEGE OF ARTS
& SCIENCES**
Primarily a correspondence
school
Chartered 1935
5719-M Santa Monica Blvd. Hollywood 38, Calif.

FREE! ELECTRONICS CAREER KIT

If you're interested in breaking into a good-paying job in Radio-TV-Electronics, I.C.S. will send you absolutely free a famous Career Kit with 3 famous booklets that have helped thousands of others—just like yourself—on the road to real success. Includes:

- 1 "HOW TO SUCCEED" Career Guide—36-page gold mine of career tips and information.
- 2 "JOB CATALOG" of opportunities in your field of interest.
- 3 "SAMPLE LESSON" (math) to demonstrate the famous I.C.S. method.

Send today for your free I.C.S. Career Kit with these 3 famous booklets. There's no obligation. This may be the big break you've been waiting for. Mark and mail the coupon today.

INTERNATIONAL CORRESPONDENCE SCHOOLS

Dept. W7420D, Scranton 15, Penna.
Please send free Career Kit with 3 famous booklets
 General Electronics Radio-TV Serv'g Practical Electrician
 Industrial Electronics Sound Equip. Serv'g Profess'l Eng. (Elec.)
 Radio-TV Eng'r'g Electrical Eng'r'g Electrical Drafting
 Electronic Servicing Electrical Tech. Other _____
Name _____ Age _____
Address _____
City _____ State _____

FREE CAREER BOOKLET

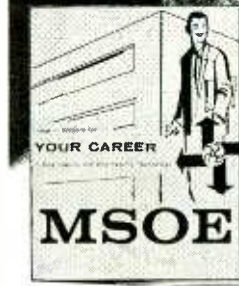

to guide you to a successful future in

ELECTRONICS RADIO-TV COMPUTERS ELECTRICAL ENGINEERING

This interesting pictorial booklet tells you how you can prepare for a dynamic career as an Electrical Engineer or Engineering Technician in many exciting, growing fields:

**MISSILES • RADAR • RESEARCH
ELECTRICAL POWER • ROCKETRY
AUTOMATION • AVIONICS
SALES • DEVELOPMENT**

Get all the facts about job opportunities, length of study, courses offered, degrees you can earn, scholarships, part-time work — as well as pictures of the Milwaukee School of Engineering's educational and recreational facilities. No obligation — it's yours free.

MILWAUKEE SCHOOL OF ENGINEERING

MAIL COUPON TODAY!

MILWAUKEE SCHOOL OF ENGINEERING
Dept. RE-562, 1025 N. Milwaukee St.
Milwaukee, Wisconsin MS-113
Please send FREE "Your Career" booklet
I'm interested in Electronics Radio-TV
 Computers Electrical Engineering
 Mechanical Engineering
(PLEASE PRINT)

Name _____ Age _____

Address _____

City _____ Zone _____ State _____

I'm eligible for veterans education benefits.

Discharge date _____

R-E**Classified****ADS**

Rates—50¢ per word (including name, address and initials. Minimum ad 10 words. Cash must accompany all ads except those placed by accredited agencies. Discount, 10% for 12 consecutive issues. Misleading or objectionable ads not accepted. Copy for July issue must reach us before May 12, 1962.

RADIO-ELECTRONICS, 154 West 14 St., New York 11, N. Y.

SERVICES

FREE CATALOG: Parts, Equipment, meter — equipment repairs, **BIGELOW ELECTRONICS**, Bluffton, Ohio.

TV TUNERS—rebuilt or exchanged, \$9.95 complete—all types—fast, guaranteed service. Send tuner with all parts to: **L. A. TUNER EXCHANGE**, 4611 W. Jefferson Blvd., Los Angeles 16, Calif.

TRANSISTORIZED products dealers catalog, \$1. **INTERMARKET**, CPO 1717, Tokyo, Japan.

ALL MAKES OF ELECTRICAL INSTRUMENTS AND TESTING equipment repaired. New and used instruments bought, sold, exchanged. **HAZELTON INSTRUMENT CO.**, 128 Liberty St., New York, N.Y.

FOR SALE**Electronics**

INVESTIGATORS, write for free brochure on latest miniature electronic listening devices. **DEPT 5C**, 11500 NW 7th Ave. Miami 50, Fla.

INDUSTRIAL TUBES TYPE 5555 \$95.00—**CRT 7MP7** \$10.00—**ELC-6-A** \$6.00 many others. Write your requirements **SPERA ELECTRONICS** 37-10 33 St., L.I.C., N.Y.

PRECISION RESISTORS, carbon-deposit. Guaranteed 1% accuracy. Millions in stock. ½ watt, 8¢. 1-watt, 12¢. 2-watt, 15¢. Leading manufacturers. **ROCK DISTRIBUTING CO.**, 902 Corwin Rd., Rochester 10, N.Y.

SHORT CIRCUITS pinpointed within 5 feet or your \$4.50 back. Own a patented pocket-size Dynamic Short Locator. **DYNAMICO**, 11370 SW 60th Terr., Miami 43, Fla.

SCHEMATICS, repair information. Television \$1.50. Radio 75¢. Send make and model. **SCHEMATICS UNLIMITED**, Box 65, Flushing 64, N.Y.

SCHEMATIC DIAGRAMS, exact replacement parts orders: Japanese transistor or tube radios, recorders, transceivers, electronics equipment. Give model and manufacturer, \$1.00. **TECHERVICES**, CPO 849, Tokyo, Japan.

PROFESSIONAL ELECTRONIC PROJECTS—Organs, Timers, Computers, etc.—\$1 each. List free. **PARKS**, Box 1665, Lake City, Seattle 55, Wash.

ELECTRONIC SURPLUS CATALOG, 5,000 items. Send 10¢. **BILL SLEP CO.**, Drawer 178R, Ellenton, Fla.

DIAGRAMS for TV, \$2.00; for radio, \$1.00. **HIETT DIAGRAMS**, Box 816, Laredo, Tex.

BEFORE YOU BUY Receiving Tubes or Hi-Fi Components send now for your giant **FREE Zalytron** current catalog—featuring nationally known Zalytron First Quality TV-Radio Tubes, Hi-Fi Stereo Systems, Kits, Parts, etc. All priced to Save You Plenty—Why Pay More? **ZALYTRON TUBE CORP.**, 220 W. 42nd St., N.Y.C.

SAVE DOLLARS on Radio, TV Tubes. Brand new. Parts at less than manufacturer's cost. 100% Guaranteed. No rebrands or pulls! Request bargain bulletin. **UNITED RADIO**, Box 1000-R, Newark, N.J.

DIAGRAMS FOR REPAIRING RADIOS, \$1; television \$2. Give make and model. **DIAGRAM SERVICE**, Box 672 RE, Hartford 1, Conn.

DIAGRAMS: Television \$1.25, Radio \$.50. **MISC. SALES**, 129 Cooper, Santa Ana, Calif.

FREE BRAND-NEW FAMOUS-BRAND TUBES. Catalog. Discounts to 75% from list. Picture tubes at 75¢ inch up; parts, kits at 1/10 original cost. Phono needles, tube testers, silicones, seleniums, 7" TV bench test tube — \$6.99 — and more. **ARCTURUS ELECTRONICS CORP.** RE, 502 22nd St., Union City, N.J.

SMALL SET BUILDER'S big information catalogue—25¢, refundable. **LABORATORIES**, 1131-B Valota, Redwood City, Calif.

PRINTED CIRCUITS. Free catalog lists hundreds of circuits. **CLOUD "9" ENGINEERING**, Brookdale, Calif.

SAVE UP TO 60% ON HEATHKIT'S BIG DISCONTINUED-KIT SALE. Send for **FREE** copy of special Heathkit Discontinued-Kit Sale Brochure! Lists dozens of brand new kits for hi-fi, stereo, amateur radio, test instruments, etc. You can buy at big savings. Write **HEATH COMPANY**, Benton Harbor 20, Mich.

HEATHKIT 10-10 "SPACE SAVER" 3" dc oscilloscope with PK-1 probe. \$100. **MARVIN MOSS**, Box 3345, Univ. Station, Gainesville, Fla.

CONVERT ANY TELEVISION TO SENSITIVE, Big-screen oscilloscope. Only minor changes necessary. Plans \$1.95. **RELCO**, Box 10563, Houston 18, Texas.

FOR SALE, 1—**BC610E** complete with spare tubes \$600.00. 160 to 10 meter—1—**NC183R**—with Pam Adapter \$200.00. All like new on air—**W7OHG**. **DON CLARK COMMUNICATIONS**, 99 Northwest Main St., Blackfoot, Idaho.

APPLIANCE LAMP — Vacuum parts. Wholesale illustrated distributors catalog 25¢. **SECO**, 112 S. 20th St., Birmingham 3, Ala.

Audio—Hi-fi

COMPONENTS, Recorders, Tapes. **FREE** Wholesale Catalogue. **CARSTON**, 125-T East 88th St., New York 28, N.Y.

TAPE recorders, Hi-Fi components, Sleep-learning equipment, Tapes, Unusual values. Free catalog. **DRESSNER**, 1523R Jericho Turnpike, New Hyde Park, N.Y.

DON'T BUY HI-FI COMPONENTS, Kits, Tape, Tape Recorders until you get our low, low return mail quotes. "We Guarantee Not To Be Undersold." Wholesale Catalog Free. Easy Time Payments Plan, 10% down—up to 24 months to pay. **HIFIDELITY CENTER**, 220 RC E 23 St., New York 10, N.Y.

HI-FI AMPLIFIERS, TUNERS, SPEAKERS, WALKIE-TALKIES, Radios, Telescopes, Microscopes, Cameras, low prices. Free Catalog. **GM PHOTOELECTRONICS**, 623 Gay St., Knoxville 2, Tenn.

SAVE 30%. Stereophonic music on tape. Request tape, recorder Catalog R-1. **SAXITONE TAPE SALES**, 1776 Columbia Rd, Washington 9, D.C.

RENT STEREO TAPES—over 2,500 different—all major labels—free catalog. **STEREO-PARTI**, 811-RE, Centinela Ave., Inglewood 3, Calif.

SALE ITEMS. Component quotes. Bulk tapes. **BAYLA CO.**, Box 131-RE, Wantagh, N.Y.

GARRARD Model A and a Dual 1006 or Miracord Studio record changer, Pickering 380C, Empire 108, Shure M 7 D or Miracord cartridge. Any changer cartridge combination \$64.50. Any three cartridges \$34.50, 25% deposit, balance COD. **PROFESSIONAL HI FI**, 248-52 Jericho Turnpike, Bellerose, N.Y.

General

FREE GIANT WHOLESALE CATALOG, Electronics, HiFi, Tools, Tubes, Radios, Imports Housewares, Photos, optics, appliances, survival products. Write **LEKTRON** 241 Everett Ave., Chelsea, Mass.

U. S. GOVERNMENT SURPLUS—Jeeps, \$264.00, Radios \$2.53, Guns, Typewriters, Cameras, Tools; thousands of items. Fabulously low surplus prices. Complete information sent immediately. Send \$1.00 to: **SURPLUS**, P.O. Box 512-NN, New Orleans 1, La.

COMMUNICATIONS, Teletype, unusual surplus bargains. Free Flyer. **MDC**, 923 W. Schiller, Philadelphia 40, Pa.

BUSINESS AIDS

BUSINESS CARDS, LABELS, RUBBER STAMPS. Send for free descriptive literature, **HEIGHTS INDUSTRIES**, Capitol Heights 27, Md.

LETTERHEADS — Billheads — Envelopes — Statements. Super special. Free details. **OKAYPRINTER**, Martins Ferry, Ohio.



FOLDED DIPOLES LAST LONGER

When folded dipole antennas fashioned from 300-ohm ribbon line break from flexing and wind vibration, eliminate the trouble by suspending the antenna from a messenger cable.

Measure a length of nonmetallic core plastic clothesline about two feet longer than the antenna. Fasten it at a convenient height under slight tension and attach the antenna to this line every few feet with plastic insulating tape.

Also, tape the lead-in cable to another length of clothesline tied to the center of the antenna supporting line, then tie the clothesline to the insulators on the supporting halyards and haul it up. Such rigging makes for minimum maintenance and antenna failure.—*Harry J. Miller*

THIN-WALL SOCKET WRENCHES

The inexpensive variety of socket wrench sold by auto supply and mail-order houses can be easily ground or filed down to the thin-walled type often needed for meter repairs where nuts

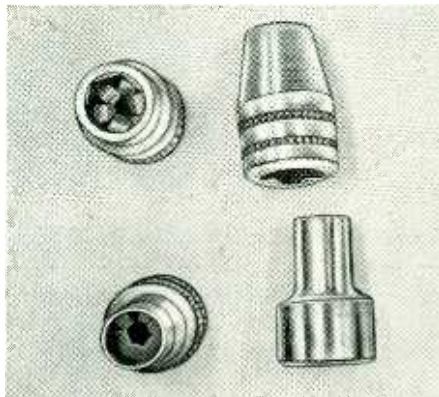

are recessed. If a power grinder and an electric drill are available, the job is that much easier. Chucked in an electric drill or drill press, a final polish can be applied that is better than the original finish on the sockets.—*E. C. Carlson*

TESTING SELENIUM RECTIFIERS

Set your tube checker for a 35Z5 and connect test leads between socket pin 8 (cathode) to the positive terminal of the rectifier and from socket pin 5 (plate) to the negative terminal of the

rectifier. Then continue checking as if testing a 35Z5 for emission. If the meter indicates anything other than good, the rectifier should be replaced.—*W. A. Auiler*

CUTTING RUBBER GASKETS

Using a razor blade to cut a rubber gasket for an appliance by following around a templet of the gasket often turns out a gasket that has jagged or distorted edges. We avoid this by cutting a slot in the copper tip of a soldering iron, inserting the razor blade in the slot and locking it with set-screws tapped into the tip. Then, by maintaining a steady heat on the razor blade, it makes the cleanest kind of cut.—*H. Josephs*

HOT-PENCIL HINT

You can store a hot soldering pencil in your tool kit without danger of fire by putting the pencil in a spool of solder



as shown. Remember this handy time-saving hint next time you are out on a service call.—*Scott Mack* END

TV-RADIO SERVICE DEALERS. No investment—We furnish you complete consignment stock RAYTHEON tubes. Regular dealer discount plus premiums, free caddy, advertising. Write for information. OMEGA ELECTRONICS, Dept. R, 397 7th Ave., Brooklyn 15, N.Y.

RUBBER STAMP—Up to four lines \$1.00. Guaranteed. CHAMBERS, 8316-1 Hanon, Ft. Worth 8, Texas.

EDUCATION/ INSTRUCTION

SLEEP LEARNING. Startling method 92% effective. Brochure free. ASR FOUNDATION, Box 21RE, Henry Clay Station, Lexington, Ky.

TAKE BACHELOR'S and Master's Degree correspondence courses from leading Universities! Directory of 6,000 courses—\$2.00. COLLEGE RESEARCH, North Highlands 14, Calif.

CIE Master Course, cheap. W4SOR, 1015 Goodbar Dr., Nashville, Tenn.

LEARN WHILE ASLEEP, Hypnotize with your recorder, phonograph or amazing new Electronic Educator endless tape recorder. Catalog, details free. SLEEP-LEARNING ASSOCIATION, Box 24-RD, Olympia, Wash.

NEW CONCEPT OF LEARNING SELF-HYPNOSIS! Now on tape or record! Free Literature. MCKINLEY-SMITH CO., Dept. T5, Box 3038, San Bernardino, Calif.

WANTED

CASH PAID! Sell your surplus electronic tubes. Want unused, clean radio and TV receiving, transmitting, special purpose, Magnetrons, Klystrons, broadcast types, etc. Want military & commercial lab/test and communications equipment such as G.R., H.P., AN/UPM prefix. Also want commercial receivers and transmitters. For a fair deal write BARRY, 512 Broadway, New York 12, N. Y. WALKER 5-7000.

G-R, H-P, L&N, etc.; tubes, manuals, military electronics. ENGINEERING ASSOCIATES, 434 Patterson Road, Dayton 19, Ohio.

UPX-4 WANTED. Surplus IFF ground station. Advise best price. M. W. Pflaumer, THE HILL SCHOOL, Pottstown, Pa.

MISCELLANEOUS

GIANT ARMS. Dr. Young's D. C. Revolutionary discovery. \$2.00. Satisfaction or refund. GAUCHO, Box 9309-X5, Chicago 90, Ill.

INDEPENDENT THINKERS—investigate Humanism! Free literature. AMERICAN HUMANIST ASSOCIATION, Dept. REI, Yellow Springs, Ohio.

MODEL RELEASES, Forms 100—\$1.00. STUDIO, Box 1143-F, Santa Barbara, Calif.

PRINTING PRESSES, type, supplies. List 4¢. TURNBAUGH SERVICE, Mechanicsburg, Pa.

BUY/RENT COMEDY, PARTY RECORDS. Sampler and catalogs, \$1.00. DRC, Dept. RE-5, 11024 Magnolia Blvd., No. Hollywood, Calif.

BOOK 200 Electric Stunts \$1.00. CUTT-RADO, 875 Arastradero, Palo Alto, Calif.

DO SECRET INVESTIGATIVE WORK With supersensitive, directional microphone. Detects a whisper at great distances. Easily constructed for \$7. Step by step plans \$1.95. DEE COMPANY, Box 7263-A, Houston 8, Texas.

EXOTIC EARRINGS! Details Free. Pair, \$1.00. OHGA, RA-345, Sigakenkusatu, Japan.

RECEIVE BIG MAIL! Samples, Magazines, Catalogs. Get listed! 25¢. LOGAN, (300-E), 8-288 Charles, Winnipeg, Manitoba, Canada.

GLOBAL Tape Recording Exchange Hobby Club: We bring the USA and world to you via tape. This is the most rewarding hobby known for all ages. Tapesponding can put you in contact with people all over the world for exchanges of ideas, music, educational knowledge or small talk. Free details. Write to MAILWAY CO. 216 W. Jackson Blvd., Chicago 6, Ill. or 51 W. 35th St., New York 1, N.Y. or 601 S. Vermont, Los Angeles 5, Calif. or 2006 E. Courtland, Spokane 27, Wash.

MERCURY TV TUNER SERVICE

890-2 River Ave., Bronx 51, N.Y.

"Largest in the East"

VHF-UHF TUNERS

7 Months Warranty

Price Includes Labor & Minor Parts

TUBES & MAJOR PARTS
AT NET PRICES

ALL MAKES
ONE PRICE!

\$9.50

When Shipping Tuner: Include Tubes,
Shields and Damaged Parts.
Give Model Number and State Complaint

PACK WELL AND INSURE
24 HOURS ON POPULAR TYPES

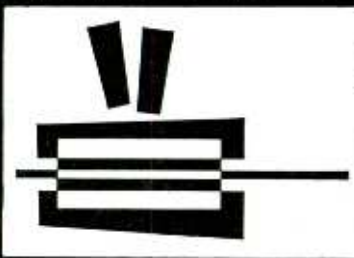

AC CIRCUIT ANALYSIS, edited by A. Schure. John F. Rider Publisher Inc., 116 W. 14 St., New York 11, N.Y. 5 1/2 x 8 1/2 in. 104 pp. \$1.80.

Analysis of ac circuits with the help of the j-operator.

CITIZENS BAND RADIO, by Allan Lytel. John F. Rider Publisher Inc., 116 W. 14 St., New York 11, N.Y. 5 1/2 x 8 1/2 in. 152 pp. \$3.90.

Techniques and rules governing this popular band as well as design, operation, installation and repair of CB equipment.

WORLD RADIO-TV HANDBOOK, 1962 Edition. Available in U. S. from Gilfer Assoc., Box 239, Park Ridge, N. J. 6 1/2 x 8 1/2 in. 228 pp. \$3.

Claimed to be the only book listing all international shortwave broadcasting stations with full data on schedules, programs, frequencies, personalities, interval signals, etc., this work has now reached its 16th edition. It is more than ever the handbook standby of the serious shortwave listener.

TRANSIENT CIRCUIT ANALYSIS, by Y. H. Ku. D. Van Nostrand Co., Inc., 120 Alexander St., Princeton, N.J. 6 x 9 in. 441 pp. \$13.

A graduate course covering the mathematical analysis of electrical and mechanical systems.

HOW TO SOLVE PHYSICS PROBLEMS, by Edwin M. Ripin. John F. Rider Publisher Inc., 116 W. 14th St. New York 11, N.Y. 5 1/2 x 8 1/2 in. 122 pp. \$1.80.

This book, written for high school and college students, presents practical problems and shows how to solve them.

TRANSISTOR CIRCUIT MANUAL, by Allan Lytel. Howard W. Sams & Co. Inc., 1720 E. 38 St., Indianapolis, Ind. 5 1/2 x 8 1/2 in. 255 pp. \$4.95.

Schematics and descriptions of over 200 instruments, including amplifiers, power supplies, radio-TV, switches, etc.

TV TROUBLE TRACER, 1962 Edition, by H. G. Cisin. H. G. Cisin, Publisher, Amagansett, N. Y. 5 1/2 x 8 1/2 in. 45 pp. 50¢.

Vol. IX contains chassis layouts of thirty-one 1961-1962 TV sets and illustrated descriptions of 50 TV troubles, giving symptom, cause and remedy.

1962 SUPPLEMENT TO CISIN'S TUBE REPLACEMENT GUIDE, by H. G. Cisin. Harry G. Cisin, Publisher, Amagansett, N. Y. 5 1/2 x 8 1/2 in. 21 pp. 50¢.

Divided into three sections—replacements for US vacuum tubes, foreign tubes, and picture tubes. Notes indicate special features such as parallel heater circuits, good or better than the original substitutes, and temporary substitutes only. END

keep up with servicing

READ

Radio-Electronics

EVERY MONTH

subscribe now

1 YEAR \$5
2 YEARS \$9
3 YEARS \$12

RADIO-ELECTRONICS • 154 West 14th St. • New York 11, N. Y.



Send for NEW
FREE CATALOG #961
with oscillator
circuits

Citizen Band
Class "D" Crystals **\$2.95** EACH

CITIZEN BAND CLASS "D" CRYSTALS 3rd overtone — .005% tolerance — to meet all FCC requirements. Hermetically sealed HC6/U holders. 1/2" pin spacing. .050 pins. (Add 15¢ per crystal for .003 pins).

All 22 megacycle frequencies in stock: 26.965, 26.975, 26.985, 27.005, 27.015, 27.025, 27.035, 27.055, 27.065, 27.075, 27.085, 27.105, 27.115, 27.125, 27.135, 27.155, 27.165, 27.175, 27.185, 27.205, 27.215, 27.225.

Matched crystal sets for ALL CB units (Specify equipment make and model numbers) ... \$5.90 per set

RADIO CONTROL CRYSTALS

in HC6/U HOLDERS—SIX FREQUENCIES
In stock for immediate delivery (frequencies listed in megacycles); tolerance—.005%. 1/2" pin spacing. .050 pin diameter. 1.00¢ plus available. add 15¢ per crystal. Specify frequency desired.
26.995, 27.045, 27.095, 27.145, \$2.95
27.195, 27.255. \$2.95
(add 5¢ per crystal for postage-handling)

ENGINEERING SAMPLES and small quantities for prototypes now made at either Chicago or Fort Myers plants with 24 hour service. IN CHICAGO, PHONE Gladstone 3-3555

IF YOUR PARTS DEALER DOESN'T STOCK Texas Crystals, order direct and send us his name.

RUSH YOUR ORDER NOW TO

TEXAS CRYSTALS
1000 Crystal Drive, Fort Myers, Florida
Dept. RE Phone WE 6-2100

FOR SHIPMENT VIA FIRST CLASS MAIL AT NO EXTRA COST ATTACH THIS ADVT. TO YOUR ORDER!

HANDY-TALKIE TRANSISTOR-PHONE



2 FOR
\$14.95

• Sets up in Minutes!
• Talk & Listen at Same Time!
Can be used for any communication need, for answering the door—comes to room—office to office—upstairs or down. Compare this to units that sell twice our price.



10 WATT
FAMOUS BRANDS
MAIN AMPLIFIER
15-WATT MAX. OUTPUT
FROM U. S. BEST KNOWN HI FI UNITS SELLING FROM \$300 TO \$350. FACTORY TESTED, READY TO BE MOUNTED IN SHELF, CLOSET OR CABINET. USE TWO FOR 20 WATT STEREO. 30-WATT FULL POWER.
\$16.95
2 FOR \$29.95

AT NO EXTRA CHARGE WITH EACH AMPLIFIER SOLD
STEREO CONTROL CENTER
No knobs included
PERMITS PLAYING OF STEREO RECORDS THROUGH ONE OR TWO AMPLIFIERS.
\$2.95
WHEN PURCHASED ALONE

Write for Free Catalog.
GM PHOTOELECTRONICS
623 So. Gay St. Knoxville 2, Tenn.

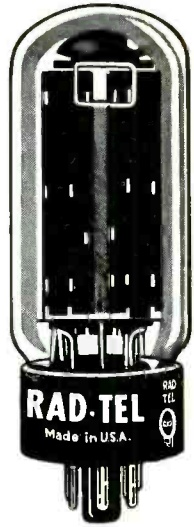

RAD-TEL Sells Direct to You...At Low Prices

The Leading "DIRECT-BY-MAIL" Tube Company



The Sign of
RAD-TEL'S
RELIABILITY

RAD-TEL'S Quality Brand-New Tubes

UP / TO 75% OFF

1-Year Guarantee - 1 Day Service - Over 500 Types in Stock

FREE!

Send For New Tube
& Parts Catalog

Send For Trouble
Shooting Guide

NOT AFFILIATED WITH ANY OTHER MAIL ORDER TUBE COMPANY

EACH TUBE INDIVIDUALLY & ATTRACTIVELY BOXED & BRANDED RAD-TEL

Qty.	Type	Price	Qty.	Type	Price	Qty.	Type	Price	Qty.	Type	Price	Qty.	Type	Price	Qty.	Type	Price
—	0Z4	.79	—	5CL8	.76	—	6B17	.79	—	6EY6*	.75	—	12AE6	.43	—	12EN6	.78
—	1AX2	.62	—	5CM8*	.90	—	6BK7	.85	—	6F5GT	.39	—	12AE7	.94	—	12EZ6	.53
—	1B3	.79	—	5CQ8	.84	—	6BL7	1.00	—	6FE8	.75	—	12AF3	.73	—	12F8	.66
—	1DN5	.55	—	5CZ5*	.72	—	6BN4	.57	—	6GH8	.80	—	12AF6	.49	—	12FA6	.79
—	1G3*	.79	—	5EA8	.80	—	6BN6	.74	—	6GK6*	.79	—	12AJ6	.46	—	12FM6	.43
—	1J3*	.79	—	5EU8	.80	—	6BQ6	1.05	—	6GN8*	.94	—	12AL5	.45	—	12FR8	.91
—	1K3*	.79	—	5J6	.68	—	6BQ7	1.00	—	6H6	.58	—	12AL8	.95	—	12FX8	.85
—	1R5	.62	—	5T8	.81	—	6BS8	.90	—	6J5GT	.51	—	12AQ5	.60	—	12GC6	1.06
—	1S4	.59	—	5U4	.60	—	6BU8	.70	—	6J6	.67	—	12AT6	.43	—	12J8	.84
—	1S5	.51	—	5U8	.81	—	6BX7	1.02	—	6K6	.63	—	12AT7	.76	—	12K5	.65
—	1T4	.58	—	5V3	.90	—	6BY5	1.15	—	6L6	1.06	—	12AU6	.51	—	12L6	.58
—	1U4	.57	—	5V6	.56	—	6BY6	.54	—	6N7	.98	—	12AU7	.60	—	12SA7	.92
—	1U5	.50	—	5X8	.78	—	6BY8	.66	—	6S4	.51	—	12AV6	.41	—	12SF7	.69
—	1X2B	.82	—	5Y3	.46	—	6BZ6	.55	—	6SA7GT	.76	—	12AV7	.75	—	12SH7	.49
—	2AF4	.96	—	6A8G	1.20	—	6BZ7	1.01	—	6SG7GT	.41	—	12AX4	.67	—	12SJ7	.67
—	2BN4	.64	—	6AB4	.46	—	6BZ8	1.09	—	6SH7GT	.49	—	12AX7	.63	—	12SK7	.74
—	2EN5*	.45	—	6AC7	.96	—	6C4	.43	—	6SJ7	.88	—	12AY7	1.44	—	12SL7	.80
—	3AL5	.42	—	6AF3	.73	—	6CB6	.55	—	6SK7GT	.74	—	12AZ7	.86	—	12SN7	.67
—	3AU6	.51	—	6AF4	.97	—	6CD6	1.42	—	6SL7GT	.80	—	12B4	.63	—	12SQ7	.78
—	3AV6	.41	—	6AG5	.68	—	6CE5*	.57	—	6SN7GT	.65	—	12BA7	.84	—	12U7	.62
—	3BA6	.51	—	6AH4	.81	—	6CF6	.64	—	6SQ7	.73	—	12BD6	.50	—	12V6	.53
—	3BC5	.54	—	6AH6	.99	—	6CG7	.61	—	6T4	.99	—	12BE6	.53	—	12W6	.69
—	3BE6	.52	—	6AK5	.95	—	6CG8	.77	—	6T8	.85	—	12BF6	.44	—	12X4	.38
—	3BN6	.76	—	6AL5	.47	—	6CK4*	.70	—	6U8	.83	—	12BH7	.77	—	17AX4	.67
—	3BU8	.78	—	6AM8	.78	—	6CL8	.79	—	6VG6T	.54	—	12BK5	1.00	—	17BQ6	1.09
—	3BY6	.55	—	6AQ5	.53	—	6CM6	.64	—	6W4	.60	—	12BL6	.56	—	17DQ6	1.06
—	3BZ6	.55	—	6AR5	.55	—	6CM7	.66	—	6W6	.71	—	12BQ6	1.06	—	17W6	.70
—	3CB6	.54	—	6AS5	.60	—	6CM8*	.90	—	6X4	.39	—	12BR7	.74	—	18FW6*	.49
—	3CS6	.52	—	6AS6	.80	—	6CN7	.65	—	6X5GT	.53	—	12BV7	.78	—	18FY6*	.50
—	3DG4*	.85	—	6AT6	.43	—	6CQ8	.84	—	6X8	.80	—	12BY7	.77	—	18FX6*	.53
—	3DK6*	.60	—	6AT8	.79	—	6CR6	.51	—	7A8	.68	—	12BZ7	.75	—	19AU4	.83
—	3DT6	.50	—	6AU4	.82	—	6CS6	.57	—	7AU7	.61	—	12C5	.56	—	19B66	1.39
—	3Q4	.63	—	6AU6	.52	—	6CS7	.69	—	7B6	.69	—	12CN5	.56	—		
—	3Q5	.80	—	6AU7	.61	—	6CU5	.58	—	7EY8*	.73	—	12CR6	.54	—		
—	3S4	.61	—	6AU8	.87	—	6CU6	1.08	—	7F8	.90	—	12CU5	.58	—		
—	3V4	.58	—	6AV6	.41	—	6CY5*	.70	—	7N7	.90	—	12CU6	1.06	—		
—	4BQ7	1.01	—	6AW8	.90	—	6CY7	.71	—	7S7	1.01	—	12CX6	.54	—		
—	4BZ7	.96	—	6AX4	.66	—	6DA4*	.68	—	7Y4	.69	—	12D4*	.69	—		
—	4BZ8	1.10	—	6AX5	.74	—	6DB5	.69	—	8AU8	.83	—	12DB5	.69	—		
—	4CS6	.61	—	6AX7	.64	—	6DB6	.51	—	8AW8	.93	—	12DE8	.75	—		
—	4DT6	.55	—	6AX8*	.92	—	6DE6	.58	—	8BQ5	.60	—	12DL8	.85	—		
—	5AM8	.79	—	6BA6	.50	—	6DG6	.59	—	8CG7	.62	—	12DQ6	1.04	—		
—	5AN8	.86	—	6BA8	.88	—	6DK6	.59	—	8CM7	.68	—	12DS7	.79	—		
—	5AQ5	.52	—	6BC5	.61	—	6DN6	1.55	—	8CN7	.97	—	12DT5*	.76	—		
—	5AS8*	.86	—	6BC7	.94	—	6DQ6	1.10	—	8CS7	.74	—	12DT7*	.79	—		
—	5AT8	.80	—	6BC8	.97	—	6DT6	.53	—	8CX8	.93	—	12DT8*	.79	—		
—	5AV8	1.01	—	6BD5	1.25	—	6DT8*	.79	—	8EB8	.94	—	12DU7	1.01	—		
—	5BC8	.79	—	6BE6	.55	—	6EA8	.79	—	8SN7	.66	—	12DW8*	.89	—		
—	5BE8	.83	—	6BF5	.90	—	6EB5*	.72	—	9CL8	.79	—	12DZ6	.56	—		
—	5BK7	.82	—	6BF6	.44	—	6EB8	.94	—	11CY7	.75	—	12ED5	.69	—		
—	5BQ7	.97	—	6BG6	1.66	—	6EM5*	.76	—	12A4	.60	—	12EG6	.54	—		
—	5BR8	.79	—	6BH6	.65	—	6EM7	.82	—	12AB5	.55	—	12EK6	.56	—		
—	5BT8*	.83	—	6BH8	.87	—	6EU8	.79	—	12AC6	.49	—	12EL6	.50	—		
—	5CG8	.76	—	6BJ6	.62	—	6EW6	.57	—	12AD6	.57	—	12EM6	.79	—		

New Tube Types Offered by Rad-Tel*

SPECIAL!

RAD-TEL'S TRANSISTORS

AT NEW LOW PRICES

SET TESTED* — Family 2N155,
2N178, 2N242, 2N255, 2N256,
2N307, 2N554, etc. ea.

49c

SET TESTED* — Family 2N173,
2N277, 2N441, 2N442, DS501.

79c

SET TESTED* — General replace-
ment in Transistor Radios and
experimenters projects. ea.

29c

*Set tested in Amer. Car Radio.
All Transistors PNP Germanium. Factory tested to Rad-Tel specifications.

RAD-TEL TUBE CO.
Dept. RE-5 55 CHAMBERS ST., NEWARK 5, NEW JERSEY

TERMS: 25% deposit must accompany all orders, balance COD. Orders under \$5: add \$1 handling charge plus postage. Orders over \$5: plus postage. Approx. 8 tubes per 1 lb. Subject to prior sale. No COD's outside continental USA.

ADVERTISING INDEX

Radio-Electronics does not assume responsibility for any errors appearing in the index below.

BUILD 10-25 RADIO CIRCUITS AT HOME

with the New **PROGRESSIVE RADIO "EDU-KIT"®**



only \$14.95 up
Reg. U.S. Pat. Off.

ALL Guaranteed to Work!

A Complete Home Radio Course

- BUILD Receivers
- Transmitters
- Signal Tracers
- Signal Injector
- Code Oscillator
- Sq. Wave Generator
- Amplifier

- No Knowledge of Radio Necessary
- No Additional Parts or Tools Needed
- Excellent Background for TV

WHAT THE "EDU-KIT" OFFERS YOU

The "Edu-Kit" offers you an outstanding PRACTICAL HOME RADIO COURSE at a rock-bottom price. You will learn radio theory, construction and servicing. You will learn how to build radios using regular schematics; how to solder and wire in a professional manner; how to service and trouble-shoot radios. You will learn how to work with punched metal chassis as well as the new Printed Circuit chassis. You will learn the principles of RF and AF amplifiers and oscillators, detectors, rectifiers, test equipment. You will learn and practice code, using the Progressive Code Oscillator. In brief, you will receive a basic education in Electronics and Radio, worth many times the small price you pay.

PROGRESSIVE TEACHING METHOD

The Progressive Radio "Edu-Kit" is the foremost educational radio kit in the world, and is universally accepted as the standard in the field of electronics training. The "Edu-Kit" uses the modern educational principle of "Learn by Doing." You begin by building a simple radio. Gradually, in a progressive manner, and at your own rate, you construct more advanced multi-tube radio circuits. You learn more advanced theory and techniques, and do work like a professional radio technician. These circuits operate on your regular AC or DC house current.

THE KIT FOR EVERYONE

You do not need the slightest background in radio or science. The "Edu-Kit" is used by young and old, schools and clubs, by Officers, Forces Personnel and Veterans Administration for training and rehabilitation. One of the most important aspects of the "Edu-Kit" is the Consultation Service which we provide. We welcome students to send us their problems, whether related to any of the material covered in the "Edu-Kit" course, or encountered in other experiences in the field of electronics.

THE "EDU-KIT" IS COMPLETE

You will receive all parts and instructions necessary to build several different radio and electronic circuits, each guaranteed to operate. Our kits contain tubes, tube sockets, variable, electrolytic, mica, ceramic and paper dielectric condensers, resistors, tie strips, coils, hardware, tubing, punched metal chassis, instruction Manuals, hook-up wire, solder, stationery, rectifiers, volume controls, switches, etc. In addition, you receive Printed Circuit materials, including Printed Circuit Chassis, special tube sockets, hardware and instructions. You also receive a useful set of tools, pliers, cutters, an alignment tool, professional electric soldering iron, wrench set, and self-powered, dynamic Radio and Electronics Tester. The "Edu-Kit" also includes Code Instructions and the Progressive Code Oscillator. You will also receive lessons for servicing with the Progressive Signal Tracer and the Progressive Signal Injector, a High Fidelity Guide, FCC Amateur License Training Book, and a Quiz Book.

TROUBLE-SHOOTING LESSONS

You will learn to trouble-shoot and service radios, using the professional Signal Tracer, the unique Signal Injector and the dynamic Radio and Electronics Tester. Our Consultation Service will help you with any technical problems.

J. Stakattis, 25 Poplar St., Waterbury, Conn., writes: "I have repaired several sets for my friends, and made money. The "Edu-Kit" paid for itself, and I was ready to spend \$240 for a course, but I found your ad and sent for your kit."

FREE EXTRAS

- Set of Tools • Radio Book • Radio and Electronics Tester • Electric Soldering Iron • Pliers-Cutters
- Alignment Tool • Tester Instruction Book • Hi-Fi Book • TV Book • Quiz Book • Membership in Radio-TV Club: Consultation Service • FCC Amateur License Training • Printed Circuitry • Certificate of Merit • Valuable Discount Card • Wrench Set

Choose From These Popular "Edu-Kit" Models

- #10A: 10 Circuits \$14.95
- #15A: 15 Circuits \$19.95
- #16A: 16 Circuits (includes Printed Circuitry) \$22.95
- #20A: 20 Circuits (includes Printed Circuitry and 4 Advanced Circuits) \$26.95
- #25A: 25 Circuits (includes Printed Circuitry and 9 Advanced Circuits) \$30.95

UNCONDITIONAL MONEY-BACK GUARANTEE

Please RUSH my Progressive Radio "Edu-Kit" to me. BE SURE TO INCLUDE all the FREE EXTRAS and BONUS RESISTOR and CONDENSER KITS WORTH \$7.00.

- MODEL desired _____ Price _____
- Send "Edu-Kit" postpaid. I enclose remittance in full.
 - Send "Edu-Kit" C.O.D. I will pay postage.
 - Send me FREE additional information describing "Edu-Kits."

Name _____
Address _____

Progressive "EDU-KITS" Inc.

1186 Broadway Dept. 197G Hewlett, N.Y.

Aerovox Corp.	22
Allied Radio	9
American Technical Institute	61
Amphenol-Rong Electronics Corp.	80
Audio Unlimited Inc.	108
Audion	93
B & K Manufacturing Co.	21
Brooks Radio & TV Corp.	98
Capitol Radio Engineering Institute	23
Capitol Radio Engineering Institute Atomics	22
Carston	108
Castle TV Tuner Service	81
Centralab, Div. of Globe-Union	76
Chemical Electronic Engineering, Inc.	86
CLASSIFIED ADS	104-105
Cleveland Institute of Electronics	11
Colordaptor	93
Coyne Book Publishing Div.	90
Denson Electronics Corp.	93
DeVry Technical Institute	7
Dressner	96
Dynafon Co., Inc.	95
Dynaco Inc.	77
Editors & Engineers	96
Electro-Voice Inc.	14
Electronic Chemical Corp.	92
Electronic Instrument Co. (EICCO)	91
Electronic Measurement Corp. (EMC)	79
Elpa Marketing (Thorens)	97
Electronic Publishing Co. Inc.	92
Fair Radio Sales	94
Fanon-Masco	26
Fisher Radio Corp.	87
GM Photochemicals	106
Grinsback Library Inc.	89
Grantham School of Electronics	15
Hallcrafters	86, 91
Harmon (George) Co., Inc.	88
Heald's Engineering College	92
Heath Company	59
Holt, Rinehart & Winston Inc.	82
Indiana Technical College	108
Inceptorall Co.	101
International Electronics Corp.	85
Jerrold Electronics Co.	10
Key Electronics Co.	108
Lafayette Radio	69
Mallory Co. Inc. (P. R.)	12
Mercury Tuner Service	106
Moss Electronic Inc.	106
National Radio Institute	27-28, 91, 94
National Technical Schools	5

Pacotronics Inc.	17, 67
Perma-Power Co.	81
Progressive Edu-Kits Inc.	108
Quam-Nichols Co.	24
Quietrole Co.	96
R-Columbia Products Co., Inc.	95
RCA Electron Tube Div.	back Cover
RCA Institutes	72-73
BTS Electronics Div.	13
Rad-Tel Tube Co.	107
Rider (John F.) Publisher Inc.	102
Robin Manufacturing Co.	93
Sams (Howard W.) & Co., Inc.	25, 68
Saxitone Tape Sales (Div. of Commissioned Electronics Co., Inc.)	96
Scott (H. H.) Inc.	3
Senacor	63, 65
Sonar Radio Corp.	16
Sonotone Corp.	16
Sony Corp. of America	19
Sprague	18
Stancor Electronics Inc.	95
Sylvania Electric Products Inc.	2nd Cover
T A R	100
Tarzan (Sarkes) Inc. (Tuner Div.)	29
Texas Crystals	106
Transvision	78
Turner Company	83
University Loudspeakers Inc.	3rd Cover
Utah Electronics Corp.	90
Van Nostrand (D.) Co. Inc.	95
Warren Electronics Co.	102
Wiley (John) & Sons, Inc.	96
Winegard Company	20
Wuerth Products Corp.	101
Xcelite Inc.	8

SCHOOL DIRECTORY PAGE 102, 103

- Niles Bryant School
 - Grantham School of Electronics
 - Electronic Technical Institute
 - Indiana Technical College
 - International Correspondence School
 - Milwaukee School of Engineering
 - Northroy Institute of Technology
 - Pacific International College of Arts & Sciences
 - Pathfinder School
 - Phila. Wireless Technical Institute
 - Tri-State College
 - Valparaiso Technical Institute
- Printed in USA

YOU SAVE MONEY!

RUSH US YOUR LIST OF HI-FI COMPONENTS FOR A SPECIAL QUOTATION

WRITE FOR FREE AUDIO DISCOUNT CATALOG A-15

New low prices on amplifiers, tuners, tape recorders, speakers, etc.

KEY ELECTRONICS CO.

120 LIBERTY ST.
NEW YORK 6, N.Y.

ENGINEERING DEGREE IN SCIENCE MATH 27 or 36 MOS.

B.S. degree—36 mos. • B.E. degree—27 mos.

Accelerated year-round program prepares for early employment in fields of Science and Engineering. Regular 4-year program for B.S. Degree completed in 36 months, special engineering degree program in 27. Classes start June, July, September, January, March. Quality education. Graduates employed from coast to coast. Government approved for veteran training. Students from 50 states, 40 countries, 20 buildings; dorms, gym, Campus. Save time and money. Earn board. Write for catalog, 1752 E. Washington Boulevard, Fort Wayne 2, Indiana

INDIANA TECHNICAL COLLEGE

HI-FI RECORDING TAPE

Splices Free (except 2400') Freq. Resp.: 20, 20,000 cps. 15 day money-back guarantee

3-11	12-23	24+
1200' 7" Acetate	\$1.29	\$1.17 99¢
1800' 7" Acetate	1.79	1.59 1.45
1800' 7" Mylar	1.99	1.95 1.85
2400' 7" mylar	2.69	2.59 2.49
2400' 7" tensitized mylar	2.99	2.95 2.90

Can Be Assorted. Add 15¢ Postage Per Reel
10¢ for 24+ Lot Orders

HI-FI COMPONENTS, TAPE RECORDERS

At wholesale prices shipped within 24-48 hours.
We'll airmail low quotes on your packaged Hi-Fi inquiries. Send for free wholesale catalogue.

125-RD East 88 St., New York 28, N. Y.

CARSTON Studios

AUDIO unlimited

Specializes in SAVING YOU MONEY

- ✓ FACTORY FRESH COMPONENTS
- ✓ LOWEST POSSIBLE QUOTATIONS
- ✓ FAST DELIVERY

We are FRANCHISED DEALERS for most Hi-Fi lines. Most orders SHIPPED PROMPTLY from stock. RECORDING TAPE at LOWEST PRICES. FREE 95 page STEREO CATALOG

190-R Lex. Ave., Cor. 32 St., New York 16, N. Y. Visit Our Showroom



JULIAN D. HIRSCH
of Hirsch-Houck
Laboratories

Summing up his report
for HI-FI STEREO
REVIEW, Julian
D. Hirsch wrote:

*"In my opinion,
the UNIVERSITY
CLASSIC MARK II
... is one of a
limited group of
speakers to which I
would give an
unqualified topnotch
rating."*

"Despite the popularity of bookshelf-size speaker systems, the big speaker system is far from extinct. There is still a great deal to be said for the sound quality of a really good large speaker system, one of which is University's new Classic Mark II.

In operation, the Classic Mark II handles low frequencies up to 150 cps through a 15-inch high-compliance woofer that is installed in a ducted-port cabinet. The bulk of musical program content, however, is handled by an 8-inch mid-range speaker, which covers from 150 to 3,000 cps. Above 3,000 cps, a Sphericon super tweeter takes over.

The measured indoor frequency response of the Classic Mark II was remarkably uniform. As a rule, such response curves are so far from flat that I do not attempt to correct them for the slight irregularities of the microphone's response. However, the measurements for the Classic Mark II prompted me to plot the microphone response also. This further emphasizes the uniformity of the system's frequency response. A 5-db increase in the setting of the tweeter-level control would probably have brought the range above 3,000 cps into nearly exact conformity with the microphone-calibration curve.

The low-frequency distortion of the woofer, even at a 10-watt input level, was very low, and it actually decreased at 20 cps, where the output was beginning to rise... Any good amplifier of 10 watts rating or better should be able to drive it satisfactorily.

In listening tests, the Classic Mark II sounded very clean... there was an undercurrent of bass, more often felt than heard, that was completely lacking in some other quite good speaker systems that I compared to the Classic Mark II. The speaker sounded at its best (to my ears) at moderate listening levels. At high levels the bass tended to be overpowering. A different listening room, of course, could easily alter this situation completely. Over-all, the sound was beautifully balanced, with wide dispersion and a feeling of exceptional ease. There was never a hint that three separate speakers were operating; the sound seemed to emanate from a large, unified source.

In my opinion the University Classic Mark II justifies the substantial claims that its manufacturer has made for it. It is one of a limited group of speakers to which I would give an unqualified topnotch rating. Anyone who is in a position to consider a system of its size and price would be well advised to hear it. The price of the system is \$295.00."

WRITE TODAY FOR THE COMPLETE JULIAN HIRSCH HI-FI STEREO REVIEW REPORT on the new CLASSIC, as well as the documented CLASSIC brochure and "Informal Guide to Component Stereo High Fidelity." Simply write: Desk P-4, University Loudspeakers, 80 S. Kensico Ave., White Plains, New York.



A Division of Ling-Temco-Vought, Inc.

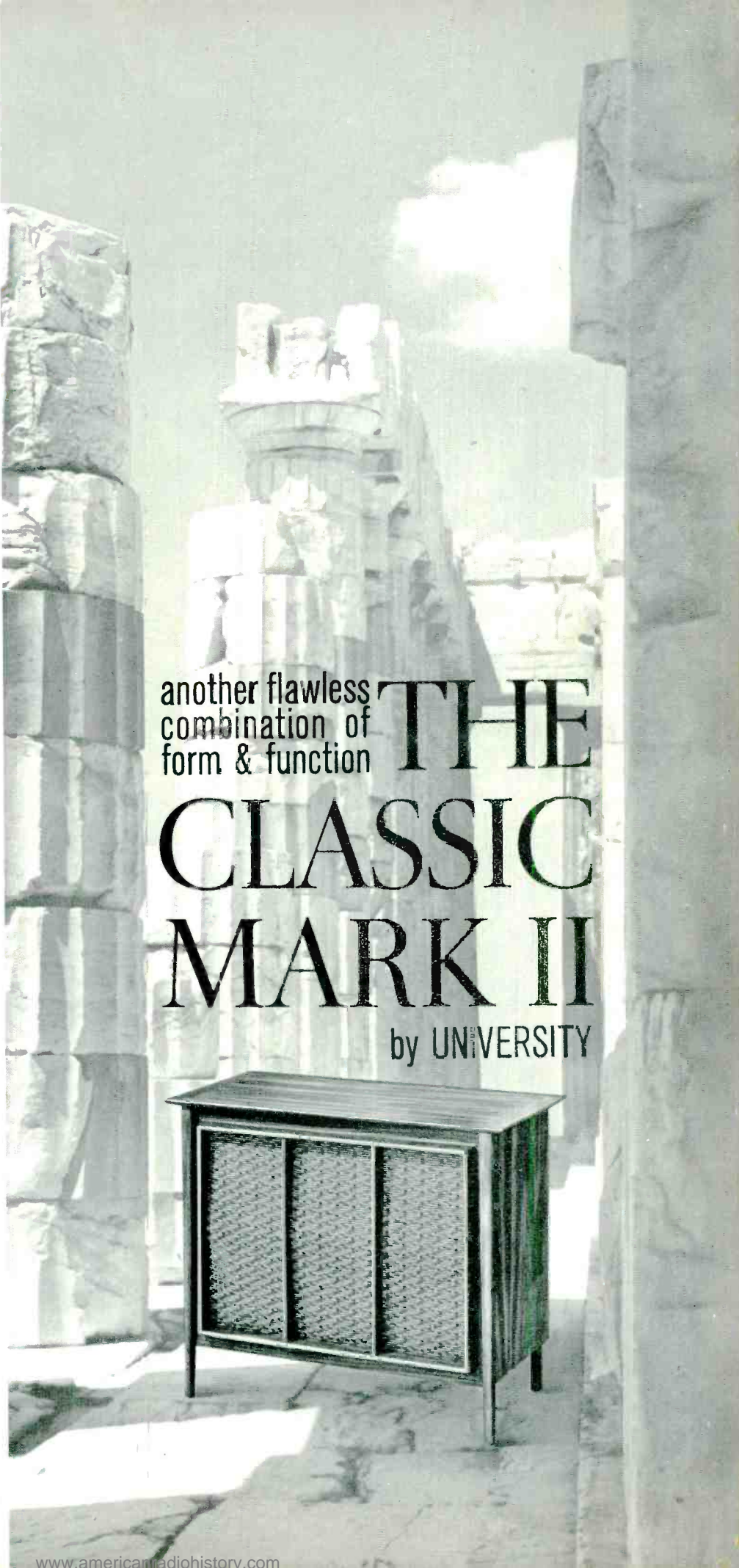

another flawless
combination of
form & function

THE CLASSIC MARK II

by UNIVERSITY

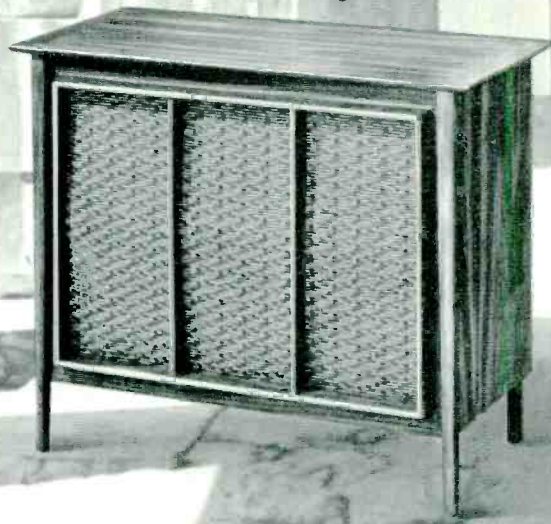

This One Picture Tube...



Replaces 19 Types

- 21ALP4 21ALP4A 21ALP4B 21ANP4 21ANP4A 21ATP4 21ATP4A 21ATP4B 21BAP4 21BNP4
- 21BTP4 21CBP4 21CBP4A 21CBP4B 21CMP4 21CVP4 21CWP4 21DNP4 21FLP4

RCA-21CBP4A UNIVERSAL SILVERAMA® PICTURE TUBE

may be installed in place of any of the above types, regardless of manufacturer.

Think of the simplicity, economy and efficiency of having just one picture tube type to take care of OVER 25% of your replacement needs. That's exactly what you get with the RCA-21CBP4A, one of a growing family of universal Silverama picture tubes designed to help you cover the maximum number of sockets with the minimum number of types. Other universal types are listed on the chart, below left.

RCA Silverama "Universal" Type	Replacing	
17BJP4	17ATP4 17ATP4A 17AVP4 17AVP4A	17BJP4 17BUP4 17CBP4 17CLP4
21AMP4A	21ACP4 21ACP4A 21AMP4 21AMP4A	21AQP4 21AQP4A 21BSP4 21CUP4
21DEP4A	21DAP4 21DEP4	21DEP4A 21CZP4
24CP4A	24ADP4 24CP4 24CP4A 24QP4	24TP4 24VP4 24VP4A 24XP4

Like all Silverama picture tubes, these universal types are made with all-new electron gun, finest parts and materials, and a high-quality glass envelope that has been thoroughly inspected, cleaned and rescreened prior to reuse.

Start simplifying picture tube replacement problems now. See your Authorized RCA Distributor this week about the new line of universal Silverama picture tubes.

Silverama Picture Tubes are advertised nationally over NBC-TV

RCA Electron Tube Division, Harrison, N. J.



The Most Trusted Name in Television